

# 21<sup>st</sup> CENTURY SCIENCE & TECHNOLOGY

July-August 1989

\$3.00

Was AIDS  
Deliberately Created?

The Apollo Project  
of the  
Renaissance  
Brunelleschi's Dome



# 21<sup>st</sup> CENTURY SCIENCE & TECHNOLOGY

Vol. 2, No. 4

July-August 1989

## Features

- 24 Brunelleschi's Dome:  
The Apollo Project of the Golden Renaissance**  
*Nora Hamerman and Claudio Rossi*  
The magnificent dome of the Florence Cathedral embodies the achievement of Renaissance science—man's increasing dominion over nature—and of the individuals whose political battles made that Renaissance possible.
- 40 Brunelleschi and the Quantization of Space**  
*Lyndon H. LaRouche, Jr.*  
Brunelleschi's crucial discoveries in the 15th century are relevant today in helping us understand the role of negative curvature in representing the necessity of progress from a lower to a higher phase state.
- 46 Was AIDS Deliberately Created?**  
*John Grauerholz, M.D.*  
The shocking charge raised by a civil rights leader that AIDS was developed as a race-specific population control measure is examined in detail by a medical expert.

## News

- FUSION REPORT**
- 7 An Interview with Dr. Winston Bostick:  
'The Jury Is Still Out' on Cold Fusion
- 9 Who Fears Fusion?
- 10 Colliding Beam Fusion System Featured at Aneutronic Meeting
- SPECIAL REPORT**
- 11 The Myth Behind the Ozone Hole Scare
- BIOLOGY & MEDICINE**
- 15 AIDS As a Cross-Species Viral Transfer
- ENERGY & ENVIRONMENT**
- 20 The Truth about Solar Energy: It Costs Too Much
- ASTRONOMY**
- 56 A Way Out of the Quasar Redshift Shambles
- FUTURE SCIENTISTS**
- 61 Do Embryos Need Gravity?

## Departments

- |   |             |    |           |
|---|-------------|----|-----------|
| 2 | EDITORIAL   | 6  | VIEWPOINT |
| 3 | LETTERS     | 62 | BOOKS     |
| 4 | NEWS BRIEFS |    |           |

### EDITORIAL STAFF

#### Editor-in-Chief

Carol White

#### Managing Editor

Marjorie Mazel Hecht

#### Associate Editors

David Cherry  
Marsha Freeman  
Robert Gallagher  
John Grauerholz, MD  
Warren Hamerman  
Ramtanu Maitra  
Charles B. Stevens

#### Books

David Cherry

#### Art Director

Alan Yue

#### Advertising Manager

Marsha Freeman

#### Circulation Manager

Dana Arnest

#### SCIENTIFIC ADVISORY BOARD

Winston Bostick, PhD  
John D. Cox, PhD  
Jean-Michel Duituit, PhD  
Bertha Farfán, MD  
James Frazer, PhD  
Robert J. Moon, PhD  
Uwe Henke von Parpart  
Frank Salisbury, PhD  
John Seale, MD  
B.A. Soldano, PhD  
Jonathan Tennenbaum, PhD  
Col. Molloy Vaughn, USA (ret.)  
Daniel R. Wells, PhD

**21st Century Science & Technology** (ISSN 0895-6820) is published 6 times a year, every other month, by 21st Century Science Associates, P.O. Box 65473, Washington, D.C. 20035. Tel. (703) 777-7473. Dedicated to providing accurate and comprehensive information on advanced technologies and science policy, **21st Century** is committed to restoring American scientific and technological leadership. **21st Century** covers the frontiers of science, focusing on the self-developing qualities of the physical universe in such areas as plasma physics—the basis for fusion power—as well as biology and microphysics, and including ground-breaking studies of the historical development of science and technology.

Opinions expressed in articles are not necessarily those of 21st Century Science Associates or the scientific advisory board.

Subscriptions by mail are \$20 for 6 issues or \$38 for 12 issues in the USA and Canada. Airmail subscriptions to other countries are \$40 for 6 issues. Payments must be in U.S. currency.

Address all correspondence to 21st Century, P.O. Box 65473, Washington, D.C. 20035.

POSTMASTER: Send address changes to 21st Century, P.O. Box 65473, Washington, D.C. 20035.

Copyright © 1989

21st Century Science Associates

Printed in the USA  
ISSN 0895-6820

**On the cover:** Photograph of the dome of the Florence Cathedral by Scala/Art Resource; cover design by Virginia Baier.

# The World Needs More People!

Without a firm commitment to the core principle of Western civilization—the sacredness of human life—any society will eventually perish under the weight of its own moral degeneracy. Already in the United States today we see numbers of people, especially young people, whose minds have been kidnapped by the degenerate counterculture—its rock music, drugs, licentiousness, cynicism, and encouragement to suicide. At its worst, this atmosphere encourages a receptivity to the barbaric practices of Satanic cults.

In the past quarter century, we have been turned from a *can-do* nation, ready to develop and industrialize the world, to a nation of cultural pessimists. Although most Americans do not yet endorse the environmentalist lie that holds technology to be an evil in itself, they have become confused by the daily barrage of scare stories in the liberal media: The “planet” is in danger, we are told, not just because man is a “polluter,” but because there are too many of us. For these Malthusians, there are too many babies being born as well as too many elderly, who have become an intolerable drain upon a limited resource base.

Such thinking is just plain wrong. The proof that it is wrong has been demonstrated over the span of human history, in which the human species has grown from a population of hundreds of thousands to approximately 5 billion, while life expectancy has jumped from about 20 years, in primitive societies, to 74 in America today. Such growth has been possible because mankind has continuously surpassed the apparent limits to growth at any existing level of technology by developing new, more advanced technologies that can support more people who live longer—and better—than their forebears.

Our generation is no exception. As the promise of fusion energy, laser technologies, and high temperature superconductivity shows, we do not lack the necessary technological potential—only the will to develop it. That the majority of people in the world today do not live as well as we do is the consequence not of their numbers but of our failure to carry forward the political mission of this nation as our founding fathers meant it. With the level of science and technology available today, there is no question that we can support a population of at least 25 billion people quite comfortably. And there is every reason to suppose that when needed, we will have the technological potential on hand to support further increases in population.

We offer an even more controversial proposition: Not only can we support a vastly expanded population, but we

actually *need* an increasing rate of population growth.

Why? First, if we are to again become a society of cultural optimism, it is desirable to have one parent at home while the children are young. Yet, today both mothers and fathers are forced to work simply to make ends meet—even in situations of two-parent families. If parents are to spend more time at home supervising their children, then we will need replacements for them on the job front.

Second, it is entirely possible in the near future that we can extend the human life span to 120 healthy and productive years. This will take some modest advances in biology, coupled with the availability of adequate nutrition and medical care for all, from the point of conception on. Even so, the elderly cannot be expected to work at the same pace as in their younger years; they should increasingly supply wisdom in place of labor. Thus, their physical needs must be met by those individuals still active in the productive workforce. Unless we increase the number of young people being born, the population pyramid will become up-ended, without the numbers of younger workers necessary to maintain an expanding population of older people.

Third, we will need more people in order to fulfill our mission in space. We will need pioneers to build the first colonies—as residents on the Moon or Mars—and we will need an expanded workforce here on Earth to back up the efforts in space.

Fourth, we need many more scientists and engineers. This means a longer period of specialized training for our young people, as well as many more workers in the tangible-goods-producing sector to back up the efforts of these specialists. As productivity increases, the ratio of scientists and engineers to the workers needed in the production sector will increase—a good rule-of-thumb ratio is probably 1 to 10.

The present trend, of course, is the opposite: away from the kind of investment in industry and technology that enhances productivity—and the diversion of the workforce out of production and into the service sector. These are low-productivity jobs and they are certainly low paying. It is a trend consistent with the postindustrial Malthusian society, in which there are fewer people, who live less long and less well.

The world needs more people and it needs happy, productive people—the kind of people who look to the stars for inspiration and who know that they can solve any new problems that come their way.

# Letters



## Blueshifted Quasars?

### To the Editor:

David Cherry's article, "Redshifts and the Spirit of Scientific Inquiry" in the May-June 1989 issue was outstanding 20th century science. However, to be good 21st century science it would also have to include the few quasars that have blueshifts. We used to hear about them all the time, but not anymore. . . .

John W. Ecklin  
Alexandria, Va.

### The Author Replies

I am glad you mention them. Today, Charles Head (University of New Orleans) and Martha Moore-Head (NASA), who are spectroscopists, argue that there are quasars with blueshifts, but that their spectra are being misinterpreted in such a way that they appear to be highly redshifted.

They say that in certain quasar spectra, lines that are being identified as Lyman-alpha (that is, associated with the ground state of the hydrogen atom), and nitrogen V, appear instead to be complexes of certain blueshifted Fraunhofer lines along with other iron, copper, and titanium lines. They base their conclusions on computerized matches of emission lines and quasar emission profile modeling of E.M. Burbidge, et al.

The Heads write: "Since blueshifted lines from the iron-group appear to dominate the visible emission spectra of a significant number of quasars in the vicinity of the Hercules Cluster of galaxies, the quasars probably contain a lot of material from advanced stages of stellar nucleosynthesis. One attractive possibility is that the quasars are old galactic nuclei surrounded by huge clouds of ejecta from many previous supernovae. . . . Advanced age and motion toward the Earth both conflict with the Big Bang hypothesis."

Papers embodying this work are probably in print by now. This quotation is from two abstracts in the *Bulletin of the American Physical Society*, Jan. 1988 (33:1, p. 72).

In interpreting their findings, the Heads draw upon their knowledge of how relativistic speeds affect the redshift-blueshift phenomenon. Motion transverse to the line of sight produces a non-Doppler redshift by virtue of time dilation. A star approaching the observer may show a redshift unless the transverse component of its motion is exactly zero.

This is where the fun really begins. The Heads conclude that given the omnipresence of angular momentum in the universe, "large redshifts would strongly dominate blueshifts even without radial expansion."

But there is more. It's in *The Physics Teacher*, Feb. 1988 ("Redshifts with Obliquely Approaching Light Sources," pp. 102-104).

## Nuclear Power Saves Lives

### To the Editor:

I'm glad to see your magazine. It reminds me of the decade-ago TV program with Walter Cronkite by similar name. . . .

I note in passing your editorial hype [March-April 1989, p. 2]. The reference to 115 million people who'd be on Earth yet had we nuclear power more abundantly neglects the 95 million more who'd (presumably then) be here yet had we nuclear power more abundantly a decade ago, and by induction on successive replacements, etc. . . .

Raymond Kenneth Petry  
Kailua, Hawaii

## Gift Subscriptions Appreciated

### To the Editor:

I'd like to thank you for the gift subscription to *21st Century Science & Technology*. I recently learned that my periodical budget for academic year 1989-90 will be cut 67 percent. Having

the subscription for *21st Century* means that much more in light of such grim news.

Since the sciences and technological fields are those that change most rapidly, having periodicals is a necessity to stay abreast and for research purposes. . . .

Shary A. Fukuhara  
North Monterey High School  
Castroville, Calif.

### The Editor Replies

We are happy to arrange gift subscriptions for schools and colleges. Potential donors as well as potential recipients should write to *21st Century*, attention Gift Department.

## 21<sup>st</sup> CENTURY SCIENCE & TECHNOLOGY

Coming in the next issue

## "How Space Technology Benefits Life on Earth"

## SAVE YOUR COPIES OF 21<sup>st</sup> CENTURY

These custom-made titled cases and binders are ideal to protect your valuable copies from damage. They're designed to hold two years' issues (may vary with issue sizes), constructed with reinforced board and covered with durable leather-like material in blue, title is hot-stamped in gold, cases are V-notched for easy access, binders have special spring mechanism to hold individual rods which easily snap in.

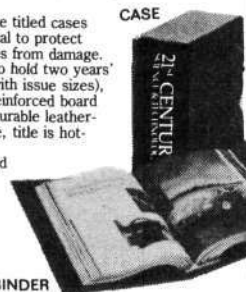

Cases: 1—\$7.95 3—\$21.95 6—\$39.95  
Binders: 1—\$9.95 3—\$27.95 6—\$52.95

21st Century Science & Technology  
Jesse Jones Industries, Dept. 21C  
499 East Erie Ave., Philadelphia, PA 19134

Enclosed is \$\_\_\_\_\_ for \_\_\_\_\_ Cases;  
\_\_\_\_\_ Binders. Add \$1 per case/binder for  
postage & handling. Outside USA \$2.50 per case/  
binder (US funds only). PA residents add 6% sales  
tax.

Print  
Name \_\_\_\_\_

Address \_\_\_\_\_  
No P.O. Box Numbers Please

City \_\_\_\_\_

State/Zip \_\_\_\_\_

CHARGE ORDERS (Minimum \$15): Am Ex, Visa,  
MC, DC accepted. Send card name, #, Exp. date.  
CALL TOLL FREE 7 days, 24 hours  
1-800-972-5858

— SATISFACTION GUARANTEED —

## NEWS BRIEFS



Robert Jastrow: The data won't support James Hansen's assertions on the Greenhouse Effect.

### PUT GREENHOUSE POLICIES ON HOLD, SAYS AUTHORITATIVE REPORT

Policies to deal with the Greenhouse Effect should not be implemented until more research is done, according to a just-issued report of the George Marshall Institute. The report was unveiled at a packed Washington press conference June 6, addressed by Dr. Robert Jastrow, founder and director for 20 years of NASA's Goddard Institute for Space Studies. Jastrow, who several years ago appointed Greenhouse Effect advocate James Hansen as head of the Institute, said that Hansen was "the odd man out" in the scientific community, and that there was no certain scientific evidence to claim that "greenhouse gas" emissions had caused the 0.7°F warming in the past century or would cause any significant harm a century hence. Coauthored by Jastrow, Frederick Seitz (former president of the National Academy of Sciences), and William Nierenberg (director emeritus of the Scripps Institution of Oceanography), the report recommends improvements in computer modeling of the atmosphere and foresees a possible natural cooling in the 21st century.

### U.S. IS COOLING, NOT WARMING, SAY ARIZONA CLIMATOLOGISTS

"The Earth may be heating but we haven't seen any evidence that the U.S. is heating," says Robert Balling, director of the Arizona State University Laboratory of Climatology. Balling and colleague Sherwood Idso issued a report in mid-May showing that the United States has cooled at least half a degree since the 1920s, based on weather records from 1,200 stations in small towns nationwide. Their findings appear in the *Journal of Geophysical Research*.

### WHO'S AIDS CHIEF DENIES GENOCIDAL INTENT IN MANAGING AIDS

Allegations that AIDS is being used to implement genocide against blacks, especially in Africa, are becoming sufficiently prevalent (see p. 46) that Dr. Jonathan Mann, head of the World Health Organization's Global AIDS Programme, felt compelled to deny them in his speech at the opening of the Fifth International Conference on AIDS in Montreal, June 5. The conference included a report from Miami researchers that 14 of 126 persons had tested positive at a Miami clinic for the homeless, with 7 of the 14 denying any risk factors. In the Wards Island homeless shelter in New York, 105 of 169 persons tested (62 percent) were found to be infected with the AIDS virus, Dr. Ramon Torres, a shelter physician, told the conference.

### WALL ST. JOURNAL FAVORS NATURE'S VERSION OF SCIENCE POLICE

A *Wall Street Journal* editorial May 15, "The Science Police," attacks a congressional subcommittee for its inquisition against Dr. David Baltimore in its campaign against "fraud in science." "Important science is self-correcting," the editorial notes. A front-page feature in the same issue, however, lionizes *Nature* magazine, emphasizing the magazine's ability to make and break science reputations. *Nature* editor John Maddox, who recently led an unprincipled attack on Dr. Jacques Benveniste with the help of Randi the magician (*21st Century*, Nov.-Dec. 1988, "says he helps create, rather than follow, fashions in science."

### LIVERMORE 'PHOTON TORPEDOES' PASS PROOF-OF-PRINCIPLE TEST

An SDI-inspired search for energy pulses that decay only very slowly has achieved some success at Lawrence Livermore National Laboratory with applications foreseen in power transmission, communications, and remote sensing as well as directed energy weapons. The pulses, with high directionality and slow energy decay (well beyond the Rayleigh length), are called electromagnetic directed-energy pulse trains (EDEPTs) and, for acoustic waves, ADEPTs. ADEPTs have now been experimentally produced in the Livermore Ultrasonic Test Bed, employing a water tank only 2 meters length. Livermore's Richard Ziolkowski reports the discovery of unexpected solutions to the wave equation that apply to a broad range of wave phenomena. Especially interesting is a modified power

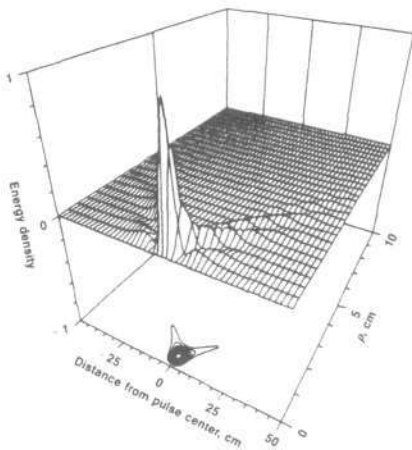

LLNL, *Energy and Technology Review*, Nov. 1988, p. 19

After traveling 10 million seconds, the theoretical field energy density of the electromagnetic MPS pulse is virtually unchanged.

spectrum (MPS) pulse mentioned in a paper coauthored by Ziolkowski in the May 1989 *Journal of Mathematical Physics*.

#### ICELANDIC DOCUMENTARY PUTS GREENPEACE ON THE DEFENSIVE

Icelandic journalist Magnus Gudmundsson brought his campaign to stop Greenpeace's economic warfare against Iceland to the United States June 8 with the first U.S. showing of his documentary, "Survival in the High North," at a Washington press conference sponsored by *21st Century* magazine. The most controversial part of the documentary shows how the torture of seals was staged deliberately to provide footage for Greenpeace fundraising films. According to Greenpeace official Dean Wilkinson, the group raises a "lot of money" on seals and whales. The 52-minute film describes the Far North economies and peoples, the history of whaling, marine research, and the Greenpeace and other interventions against the peoples of the far north. The film, already shown on television in Scandinavia and Holland, has made Greenpeace frantic. Members have described the film "as the worst crisis Greenpeace has ever faced." "They have threatened to sue me, but they haven't done so because the film tells the truth," Gudmundsson said.

#### PROTEIN IN BODY'S IMMUNE RESPONSE CAUSES MALARIAL ANEMIA

A protein produced by the body's own immune system causes the severe anemia responsible for death from acute malaria, according to researchers at Lawrence Berkeley Laboratory. Scientists at the California lab have demonstrated that much of the anemia of acute malaria can be reversed in mice by supplying an antibody to tumor necrosis factor (TNF), a protein made by the immune system's macrophage cells. "The purpose of TNF is to play a role in protection against disease and in healing, but if excessive amounts of TNF are produced, you get detrimental effects," said scientist Kathleen Miller. Malaria annually strikes between 200 and 300 million people, causing 1.5 million deaths.

#### ENERGY SECRETARY JAMES WATKINS HAILS SHOREHAM LICENSING

"The licensing of Shoreham by the Nuclear Regulatory Commission is perhaps the most important development for the U.S. nuclear industry in the past decade," said Energy Secretary Adm. James D. Watkins, April 20, after the Nuclear Regulatory Commission granted an operating license to the beleaguered N.Y. plant. Long Islanders are already "saddled with nearly the highest electricity costs in the nation, and without Shoreham, costs would increase two to five times. . . . Comparative costs for alternative power sources average about twice as much as Shoreham-produced electricity, which would cost almost 3 cents per kilowatt hour. The cost of oil-fired power would range from 8 to 11 cents. . . . To replace Shoreham with coal-fired power would double the cost of electricity and add to the atmosphere 14-34,000 tons of sulfur dioxide, 22-34,000 tons of nitrogen oxide, and 11 million tons of carbon dioxide. While gas-fired power is relatively clean, it could also double the cost of electric power." The completed nuclear power plant is slated to be dismantled, according to a plan promoted by New York's governor, Mario Cuomo.

#### IDAHO NATIONAL ENGINEERING LAB: 40 YEARS OF NUCLEAR PROGRESS

The Idaho National Engineering Lab (INEL), site of many "firsts" in U.S. nuclear history, turned 40 in May. The U.S. Atomic Energy Commission began construction on the Experimental Breeder Reactor I in May 1949, and on Dec. 20, 1951, the EBR-I became the first nuclear reactor in the world to produce electricity. INEL is also the birthplace of the Nuclear Navy, where the Submarine Thermal Reactor achieved its first successful power run May 31, 1953 in the *USS Nautilus* prototype. Now INEL is slated as the site for development of the Advanced Laser Isotope Separation program, as well as a new defense production reactor.



*Greenpeace exposed: Icelandic journalist Magnus Gudmundsson at the National Press Club in Washington, D.C. The film is available from Magned Film in Iceland.*

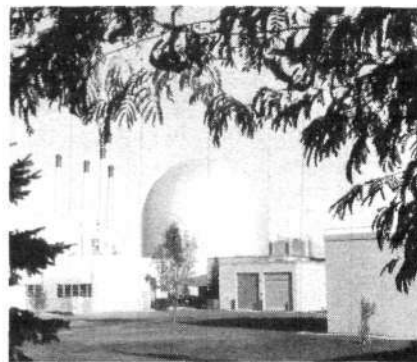

*EBR-II is the key U.S. facility for fast breeder experiments and has provided 2 million MWh of power for INEL.*

# VIEWPOINT

## The Cross That Went to the Moon

Honest to God, I don't believe in sorcery, nor in witches, talismans, or mascots; but I do have regard and even reverence for signs and symbols. The words I say or write, aren't they the exterior signs of my interior feeling and believing?

Similarly, a cross over a church, an altar, or a tomb—do they not remind many people of a God who chose to die on a cross with arms outstretched to signify His lasting embrace to mankind, whom He so strongly wanted to be close to the love of the one Father in heaven?

These are the reasons why, when I went to Russia as a missionary in 1959, I had planned to give every Russian with whom I had personal contact one of the little crosses that I purposely had had blessed here in Rome personally by the Pope.

In Moscow, some of those little crucifixes that I gave to certain people had been gratefully acknowledged with some present in exchange. For example, a student got in contact with me the day after I gave him a crucifix, and asked to meet me in an isolated place; it was not prudent to be seen with a Catholic priest from Rome. The student brought a friend who asked, as a favor, for one of the crosses "blessed by the Pope of Rome." In exchange, he gave me a Russian crucifix handed down from generation to generation.

No matter how fondly I cherished that Russian souvenir during the following 10 years, the time came when I felt that it was my duty to give it up in favor of the nearby gentle luminary of the Earth's nights.

Oh no! I did not feel such a friend of the Moon to deprive myself of an object that was so dear to me, both for what it meant to my religious faith and

*Father Giovanni Garbolino, whose missionary work has taken him around the world, is a member of the Missioni Consolata in Rome.*



Father Giovanni Garbolino

for its significance as a Russian gift. The idea of sending that cross to the Moon was twofold: first, to enhance the technical prospect of success of this "out-of-this-world" enterprise (in view of the beneficial impact that has on the human mind); second, because of the very connotation of a "plus" that the cross has in the area of mathematics as well as scientific thought.

The package containing the Russian crucifix was sent special delivery to [Apollo 11 astronaut] Col. Edwin E. Aldrin in Houston, accompanied by a letter. It was followed, a few days before the Apollo 11 voyage, with a telegram, wherein I recommended "not to forget the meaningful little cross."

The Russian cross was not left on the surface of the Moon, as I had requested. Aldrin wrote me in a letter that my wish was unfulfilled because, "We were only able to leave on the Moon a limited number of specially authorized items." But the return of my Russian cross was followed soon after by an envelope, wherein I found, as Aldrin's personal souvenir, a "little crucifix," flown to the Moon aboard the Apollo 11 spacecraft Eagle, which landed on the Moon July 20, 1969.

The story of the little cross that was on the Moon does not finish here, however. It was given to the most Reverend Cardinal Carol Wojtyla (now Pope John Paul II) on the occasion of

his name's feast day, Nov. 4, 1974, as "an homage to his missionary spirit" and his cooperation with my Order's mission enterprise in Tanzania. When he became Pope, he entrusted the lunar cross to the Cracow diocesan museum, where it can be seen by visitors.

The story of the little cross came again to my mind during my last visit to Russia in 1979, when I was surrounded and searched by the KGB at Moscow airport. They confiscated copies of *The Imitation of Christ*, the Gospel, and religious images, and they took my picture as a criminal, guilty of "smuggling religious material."

The lunar cross remains the symbol of the real ecumenical brotherhood for which John Paul II continues to be, on the order of Christ, the supreme promoter.



*The little white cross that went to the Moon, sent by Edwin Aldrin to Father Giovanni Garbolino. It is displayed here with the letter from Aldrin, a picture of the Moon, and the U.S. flag.*

# 'The Jury Is Still Out' on Cold Fusion

## EDITOR'S NOTE

As we go to press, there is no scientific verdict on cold fusion, only the grumblings of the antisience press and a chorus of naysayers in the scientific community. Meanwhile, researchers continue to report that they have replicated the production of excess heat in experiments along the lines of the University of Utah Fleischmann-Pons electrolytic cell using palladium. Researchers also continue to report that they have produced neutrons using experimental apparatus similar to that of Steven Jones at Brigham Young University.

So, there is excess heat and there are neutrons, but what exactly is "cold fusion"? We are continuing to review the scientific papers as they come into print, and we promise fuller coverage in a coming issue. Here we present some ideas of Dr. Winston Bostick, a member of 21st Century's scientific advisory board.

Bostick, a pioneer in thermonuclear fusion and the plasma focus device, attended a three-day workshop on cold fusion sponsored by the U.S. Department of Energy May 23-25 in Santa Fe, N.M. About 450 scientists from research labs, universities, government agencies, and private companies around the world were present, and dozens of papers were given.

Bostick is professor emeritus at the Stevens Institute of Technology in New Jersey. He is interviewed here by managing editor Marjorie Mazel Hecht.

**Question: How would you summarize the presentations at the "cold fusion" meeting you attended in Santa Fe?**

The jury is still out, although some of the opponents of the idea of cold fusion will tell you it's already settled, and nobody should believe in cold fusion. I think they were rather dogmatic and in some cases almost ill-mannered.

The measurements of excess heat by the Texas A&M group and by the



Marjorie Mazel Hecht

Martin Fleischmann (left) shows Rep. Marilyn Lloyd a sample cold fusion electrochemical cell at congressional hearings held April 26 by the House Committee on Science, Space, and Technology. Stanley Pons is to Lloyd's left. During his testimony, Fleischmann stressed that cold fusion should not be seen as a replacement for the existing magnetic and inertial confinement fusion programs. He said that cold fusion might prove to be a power source for small-scale systems in developing nations, while the mainline fusion program would provide large centralized power plants for industrialized nations.

Stanford University group seem to show that there is definitely a positive effect in the production of heat, which does not occur when hydrogen ( $H_2D$ ) is used instead of deuterium. It is a finite measurement which can be verified.

The A&M group also claimed that they have tritium. That's controversial, however. I think that their heat measurements are more in the clear. The Jones group from Brigham Young University was represented. The Fleischmann-Pons group was not. Jones's neutron measurements seem to have been carefully done, and Los Alamos has verified them. They get definitely positive results for the neutron measurements. I think that's a big plus-sign.

There are other groups that have put together some fairly fancy electronic

means for measuring the neutrons—the Massachusetts Institute of Technology group and the Princeton group, for example—but much more fancy electronics have been put together by the Brookhaven National Laboratory group. The loudest spokesman for that group is a chap by the name of Moshe Gai from Yale University. He's been vehement in insisting that there is no such thing as cold fusion.

There is no doubt that the electronics of this Brookhaven-Yale group are good; their background neutron counts are low. On the other hand, they are eclipsed in quality by both the Italian group, centered on Bologna, and the French group. Both European groups have used research stations inside tunnels to cut down the cosmic-ray background count tremendously.



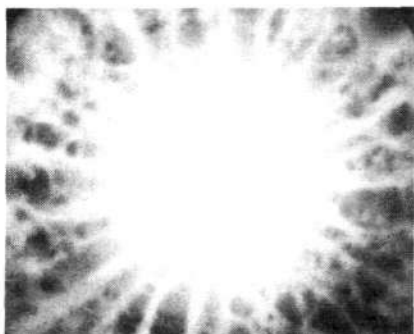

Winston Bostick

*Vortex filaments as seen in the plasma inside the plasma focus device. This is an axial view at the moment of maximum pinching, using a solid copper conductor at 11 kV operation.*

The Italian group claims that they have neutrons. The French group has no neutrons, but the crux of the matter is that the electrolytic cells do not always work.

I spoke with Steven Jones from Brigham Young University and told him, "I think you have to take your cell to Brookhaven—I suppose you could take it to France or Italy, but that's a longer trip." He said that's what he intends to do. I think this will perhaps settle the question.

The people in France, at Brookhaven, and at Princeton, are not getting neutrons because their cells aren't pickled in the right way. So we'll have to wait a few weeks and see what transpires, but I think Jones has made a good case.

**Question: Are these experiments all modeled on Steven Jones's experiment with an electrolytic cell, putting current through various combinations of elements?**

Jones's experiment is mostly with an electrolytic cell. The other experiments I mentioned do not use any electrolyte and they don't use any current. If they just expose the surface—well, they load the surface either by pressure loading or by deuteron beams—and then chill the surface and rewarm it, they will observe a burst of neutrons.

The fact that they can get neutrons and also fairly high energy nuclear-type particles from the titanium and palladium surfaces that are loaded and then cooled off and warmed up again means that there is a fracturing, a re-

lieving of mechanical stresses like little earthquakes. Out of these cracks come nuclear-type particles with nuclear energies, and if they collide they will produce bursts of neutrons. This has been observed by the Italians, by the people at the Colorado School of Mines, and others.

I talked to my colleague I. Brzosko at the Stevens Institute laboratory, and he said this type of effect has been observed since at least 1985. He said that he had observed it, and I think he said the Russians had done it also, and so on. The date may be actually earlier than that.

**Question: What about the plasma effects you and your colleagues have observed in the plasma focus device?**

I have been trying to think of what has happened in the conventional controlled thermonuclear fusion movement that has any similarity to this type of cold fusion. Of course, cold fusion will have to be defined—this phenomenon involving the fracturing is being called cold fusion, but whether it really should be, I do not know.

In the plasma focus, without using palladium or titanium to produce the energetic particles—or to produce the fusion—we can simply load a magnetic field with deuterium. The magnetic fields are strong, but the distance scales are very small and the concentrations are very large—they can go up over solid-state densities.

When the structures come apart—that is, when the magnetic fields are interfered with as the currents are broken or explode either by themselves or the fields explode—then this produces the emission of neutrons in abundance from very small sites. So the rate of production per cubic centimeter must be very, very intense.

We have never produced the ignition of deuterium in this way—we've never had the chance to try deuterium with tritium in our laboratory. Nevertheless, the plasma focus is noted as a very ready and copious source of neutrons, that is, of the fusion reactions deuterium-deuterium and deuterium-tritium. This is as much "cold fusion" as that one could get from producing neutrons from fractures in a strained piece of palladium or titani-

um that is loaded with deuterium.

So we throw this into the controversy for what it is worth.

**Question: You have been experimenting with the plasma focus device for more than 20 years, and I know that you've seen coherent structures in your plasma that the mainline fusion scientists for a long time said couldn't exist.**

People should recognize that these phenomena have been known in the plasma focus—the magnetic structures since 1965 and the very dense clusters of deuterons for the last 10 or 15 years.

**Question: Are you now saying that if you broaden the concept of cold fusion, there are many ways of producing neutrons—and fusion—that are not the mainline tokamak machines?**

Indeed, yes. The important thing is something that was not recognized when we started out with the pinch effect in plasmas [the "pinch" occurs when there is a contraction of current-bearing filaments by the surrounding magnetic field]. The fusion community tossed out the pinch effect in 1958; they thought it had no future. They never recognized that the fine structure was there—in very intense magnetic fields, very small dimensions, very highly concentrated clusters, which they never dreamed of, because these scientists were all trained on the basis of statistical mechanics concepts.

So, the mainline fusion scientists did not realize how effective an intensification process can be produced with something like the pinch effect, using high current and high magnetic field—and, it occurs automatically.

#### **The 'Pasteur' Era of Plasma Physics**

We've preached the sermon that when we discovered these effects in 1965, that was the beginning of the "Pasteur" era of plasma physics, where important things were happening at very small scales that nobody had ever seen, and that we probably still haven't seen because they go down so far in size. We've only followed them down to at least a small fraction of a micron; that's already far beyond the dreams of any of the statistical mechanics people back in 1958.

**Question: What are the dimensions of the very beautiful plasma filaments you have published in photos?**

The dimensions are a fraction of a millimeter for the filaments we see in the plasma focus with the Kerr cell cameras. However, in the effects on witness plates, which are produced by the filaments or by relativistic electron beams passing through a low-pressure gas, the diameters of the filaments go down to the region of 1 or 2 microns, and the sharpness of the boundaries goes down to a small fraction of a micron. We can see these with scanning electron microscope renditions of the witness plates, and in the images of the scanning electron microscope.

**Question: When did you begin to identify these clusters of deuterons?**

Roughly 12 years ago.

**Question: But you started out seeing the structures in the very hot plasma in the 1960s?**

I identified them in the plasma focus in 1965, but in 1954-1956 when I was working at Lawrence Livermore Laboratory, we produced plasmoids by firing a small plasma gun into a magnetic field. The plasmoids had very sharp boundaries and could bounce off one another like billiard balls. They had integrity in the sense that each plasmoid had properties of its own; and each could be produced over and over again, just by firing the gun under the same conditions. Incidentally, we produced structures of galactic form which are very interesting.

This type of observation of plasmas has given us insight not only into the structures of the size of a galaxy, and how the galaxies are made, but it's giving us insight into what's going on in the laboratory in the production of fusion that occurs over very small dimensions with very intense concentrations of plasma in the magnetic field.

**Question: You and your colleagues have been through the experience where for 15 or so years you were very clearly seeing plasma filaments, while the traditional, mainline fusion community said, "These cannot exist—our theory cannot predict them." What advice would you**



*"Fear of Fusion: What If It Works?" was the headline of a Los Angeles Times article by staff writer Paul Cioti, April 19 (p. V-1). Interviewed on the prospects of cold fusion were some of the leading U.S. environmentalists and zero-growthers—Barry Commoner, Paul Ehrlich, Jeremy Rifkin, and others. What is most horrifying to these scientific pessimists, is that successful cold fusion might permit what they fear the most: an increase in world population. Here are excerpts.*

... [G]iven society's dismal record in managing technology, the prospect of cheap, inexhaustible power from fusion is "like giving a machine gun to an idiot child," Stanford biologist Paul Ehrlich says.

Laments Washington-based author-activist Jeremy Rifkin, "It's the worst thing that could happen to our planet."

Inexhaustible power, he argues, only gives man an infinite ability to exhaust the planet's resources, to destroy its fragile balance and create unimaginable human and industrial waste.

... Worst of all to some observers, its cheap inexhaustible energy would let the planet support many more people than its current population of 5.2 billion. And this, they say, would be a crowded Earth. . . .

Stanford's Paul Ehrlich says he has no problem with the notion of cheap, clean, inexhaustible power per se, which could be a tremendous boon to mankind.

The problem: Industrialized societies, so far, have not used power wisely. . . .

And even if fusion turns out as well as it has been promoted, Ehrlich says, it won't be a panacea. Most problems in the Third World, for example, are social, political, or economic, not technological, he says. "The idea that you can solve the human dilemma with a single technological breakthrough is incorrect."

... The current unqualified euphoria for fusion also concerns Barry Commoner, director of the Center for the Biology of Natural Systems at Queens College in New York.

He argues that fusion power could prove to be a dangerous distraction from existing energy sources. It does not make sense, he says, to jump on an unproven, possibly dangerous technology like fusion when a safe, proven, and decentralized technology like solar power is there for the asking.

... To Rifkin and Ehrlich, this is the real danger of fusion power—it gives people the false hope that a technological quick fix to the world's problems is just over the horizon. "Fusion power is an expedient short-lived diversion to the real problem," Rifkin says. "It gives some people the false hope that there are no limits to growth and no environmental price to be paid by having unlimited sources of energy. . . ."



## The 'Greenhouse Effect' Is a Hoax!

*EIR's* Special Report, "The 'Greenhouse Effect' Hoax: A World Federalist Plot," analyzes the scientific truth and the political reality behind the latest environmentalist hoax: Kremlin leaders and their Trilateral Commission friends are using "ecological emergency" as the pretext to destroy the sovereignty of nations and establish one-world rule.

# EIR

**Executive Intelligence  
Review**

\$100 Order from:  
**EIR News Service, Inc.**  
P.O. Box 17390  
Washington, D.C. 20041-0390

now give to the various people who are pursuing varieties of "cold fusion" fusion experiments, while much of the scientific community says cold fusion is not possible?

I would tell them to keep up the good work: Don't let the theoreticians or even the other experimentalists talk them out of a good idea if they really believe in it. We will finally find out whether they are correct or incorrect.

In the process of finding out, we are going to uncover new things. Also, various members of the scientific community who otherwise haven't talked to each other very much are certainly meeting together and discussing things. So there will be some cross-fertilization and cross-discussions among various disciplines and various people who otherwise would never get to talk to each other.

## Colliding Beam Fusion System Featured at Aneutronic Meeting

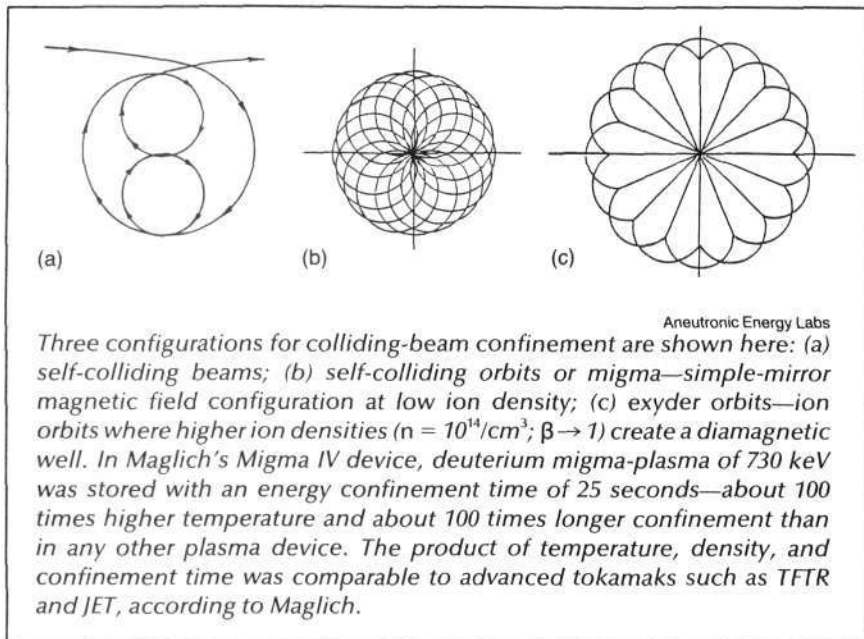

"We may be at the brink of an energy technology which is compact, safe and leaves virtually no residue but the electricity we see fit to create with it," Glenn T. Seaborg, former chairman of the U.S. Atomic Energy Commission, told the Second International Symposium on Aneutronic Power, held in Washington, D.C., April 28-29. "No other form of energy has ever come close to the degree of cleanliness and efficiency as aneutronic power," Seaborg said.

The scientific details of a U.S. Air Force-funded research program that aims to create fusion energy using colliding particle beams were revealed for the first time at this symposium. Cochaired by George Miley of the Uni-

versity of Illinois (who is the editor of the journal *Fusion Technology*) and Dr. Bogdan Maglich of Aneutronic Energy Labs, Princeton, N.J., the symposium brought together more than 100 scientists from 20 nations to discuss neutronless nuclear power.

The colliding-beam system uses a medium-energy particle accelerator, which shoots a beam of fusion fuel ions into a magnetic field. The interaction with the magnetic field causes the beam to follow a circular trajectory—the beam intersects itself. Fusion reactions take place at this intersection (see figure).

By further focusing the beam, sufficient fusion reactions can be generat-

*Continued on page 22*



Bill Rose/Michigan Technological University

## The Myth Behind the Ozone Hole Scare

by Rogelio Maduro

Without any hard scientific evidence that chlorofluorocarbons (CFCs) are causing catastrophic ozone depletion, representatives from 80 nations agreed May 2 to a total ban of CFCs by the year 2000. The decision, taken at the end of a United Nations Environment Program conference in Helsinki on "protecting" the ozone layer, goes far beyond the protocol adopted in Montreal in 1987 by 17 nations, which called merely for halving the production of CFCs by 1998.

The agreed-upon ban will have a most drastic effect in the developing sector, depriving these nations of the benefits of refrigeration using freon, a nontoxic, nonflammable, and inexpensive CFC. Proposed substitutes are three to five times more expensive, as well as more toxic to handle and more corrosive (thus requiring more frequent replacement of the refrigerator).

In nations where food is already scarce and up to 75 percent of harvests is lost to spoilage, this ban will simply mean less food or no food—in plain words, malnutrition and death. Here

*Ban volcanoes, not CFCs: This Antarctic volcano, Mt. Erebus, is spewing more than 100-200 tons of chlorine a day into the atmosphere; in 1983, 1,000 tons daily.*

in the developed sector, the ban would be an additional tax on shrinking incomes.

Also agreed upon at the U.N. meeting was the phase-out "as soon as feasible" of other "ozone-damaging" substances like halon gas, which is used in fire extinguishers. The "declaration of intent" agreed upon by these 80 nations will become an enforceable international law during another climate conference in 1990.

The well-orchestrated and well-financed campaign to phase out and ban the production of CFCs, some of the most useful chemicals ever known, is taking place with no hard scientific evidence proving that CFCs are depleting the ozone layer. This lack of evidence is compensated for by a plethora of hysterical media coverage that has made "ozone hole" a household phrase.

The scare behind ozone depletion rests on the physical properties of ozone, a molecule of oxygen containing three oxygen atoms. The ozone layer in the upper atmosphere shields the Earth from the Sun's most harmful rays.

Most of the ultraviolet radiation coming from the Sun is absorbed in the upper atmosphere in the process of creation of ozone molecules from O<sub>2</sub> oxygen molecules. If this incoming

ultraviolet radiation increases, then there is an increased risk of skin cancers.

It should be noted, however, that incoming ultraviolet radiation has significantly decreased, since measurements first began to be taken in 1974.

### The Ozone Wars

The hysteria conveyed by the media is simply the latest chapter of what became known in the 1960s and 1970s as *The Ozone Wars*, after the 1978 book by L. Dotto and H. Schiff. During the so-called ozone wars, the environmentalists alleged that various chemicals (from pesticides to fertilizers), nuclear tests, and vehicles ranging from the Supersonic Transport to the Space Shuttle were going to poke holes in the ozone layer.

Every single such theory was proven wrong by scientific observation of the behavior of the ozone layer, and the controversy died out, until 1985-1986, when banner press headlines blared that a huge ozone hole had suddenly been discovered in Antarctica by intrepid scientists from a British Antarctic expedition led by Robert Watson.

This sudden discovery of the "ozone hole" prompted a much publicized international conference in Montreal in 1987. Missing from the Montreal proceedings and from all of the press accounts was the fact that the "ozone

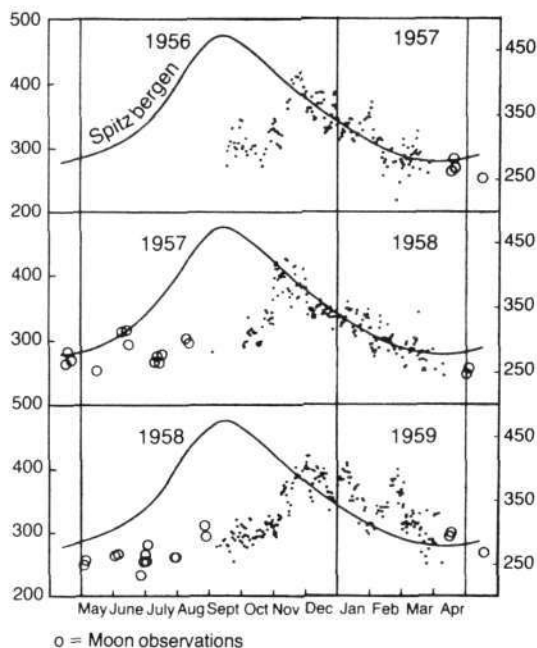

Source: *Applied Optics*, March 1968, Vol. 7, No. 3.

**Figure 1**  
**DOBSON'S OZONE OBSERVATIONS**  
**AT HALLEY BAY, ANTARCTICA, 1956-1959**

*Dobson's original caption reads: "The full curve is for Spitzbergen [near the North Pole], shifted by six months. Note the lower values of ozone in the southern spring and the sudden increase in November at the time of the final atmospheric warming."*

*The Antarctic data are shown as dots, each representing a reading of ozone layer thickness. The amount of the ozone takes a huge leap at the end of October, as can be seen, when the polar vortex breaks up.*

hole" over Antarctica was really not a new find. The ozone hole was actually discovered in 1956 by the world's leading ozone layer researcher, Gordon Dobson, and his collaborators.

Most important, back in 1956, CFCs were not in wide use, so the existence of the hole could not be blamed on them. Dobson correctly postulated the "ozone hole" to be a fascinating natural anomaly.

In addition to never mentioning the actual origin of the ozone hole, the media accounts ignore the fact that purely natural processes are responsible for most of the chlorine pumped into the atmosphere. Specifically, the evaporation of seawater, volcanic activity, and biomass burning pump hundreds of millions of tons more chlorine into the atmosphere every year than is put there by all man-made CFCs. This report reviews the basic

outline of the ozone hole hoax, while subsequent articles will cover the science in more detail.

#### Scientific Fraud

In 1974, two chemists from the University of California, F. Sherwood Rowland and Mario J. Molina, wrote the first technical paper condemning CFCs as nasty chemicals that could potentially eat up to 10 percent of the ozone layer. Because CFCs are inert chemicals (they do not react with other chemicals), Rowland postulated that large amounts of CFCs would rise 30 km into the stratosphere, by some unexplained mechanism. There, CFCs would be broken up by the same ultraviolet radiation that forms ozone molecules.

This process would result in the release of a chlorine atom, Cl, which would then combine with ozone molecules, O<sub>3</sub>, and break them up. As a

catalytic reaction, this would then continue thousands of times, with the chlorine molecule breaking up thousands of ozone molecules.

Now, this is all part of a "theoretical model." There are at least 192 chemical reactions and 48 photochemical processes that occur in the stratosphere. Most of these reactions are very fast processes involving highly reactive species, particularly free radicals and atoms in excited states, whose reactions can affect the chemistry of the stratosphere at very small concentrations. Most of these reactions are extremely difficult to reproduce in the laboratory and even more difficult to measure. It is not credible to take a couple of reactions involving just a few molecules, carry them out in a laboratory environment, and then claim this is what happens in the stratosphere (where it cannot be measured).

For this reason, Sherwood and Molina carefully prefaced their paper with the following qualifier: "We have attempted to calculate the *probable* sinks and lifetimes of these molecules" (emphasis added). Such disclaimers never make it into the press; instead, this "theoretical model" is widely reported as observed fact.

To back up their theoretical model, Rowland et al. now point to levels of chlorine at the Antarctic measuring station that have been reported to be 50 to 60 times higher than the expected levels as proof that CFCs are breaking down into chlorine.

#### The Volcano Factor

In fact, less than 15 kilometers upwind from the Antarctic observation post at McMurdo Sound is the volcano Mt. Erebus, which has been erupting continuously for more than 100 years. In 1983, samples were taken of the gases being blown into the atmosphere by Mt. Erebus, indicating that more than 1,000 tons of chlorine were being out-gassed daily. Given the high altitude of the volcano and the extremely dry conditions in Antarctica, which prevent the chlorine gases from being washed to the ground by rain, volcanologists estimate that a very large percentage of these chlorine gases must reach the stratosphere. Thus, it is not chlorine from the breakup of CFC molecules that is being measured in Antarctica, but chlorine from Mt. Erebus.

For the past year, Marcel Nicolet, he founder and director of the Institut Aéronomie Spatiale de Belgique in Brussels, has publicly refuted the claims that CFCs are depleting the ozone layer. Nicolet, one of the pioneer researchers of the ozone layer, was working with Gordon Dobson in 1956, when they discovered the ozone hole in Antarctica. He maintains that the ozone hole is a natural oscillation of the weather systems, which increases and decreases periodically.

As Nicolet told the West German newspaper *Die Zeit* Feb. 24, CFCs are not to blame for this oscillation, "The natural fluctuations in ozone and the discrepancies in measurement are simply too great."

Gordon Dobson also believed the ozone hole to be a natural phenomenon. The ozone layer is measured in Dobson units, and the standard equipment is the Dobson spectrophotometer. In an article titled "Forty Years' Research on Atmospheric Ozone at Oxford: A History," which appeared in *Applied Optics* magazine in March 1968, Dobson wrote the following:

"One of the most interesting results on atmospheric ozone which came out of the IGY [International Geophysical Year] was the discovery of the peculiar annual variation of ozone at Halley Bay. This particular ozone instrument had been to Shotover [laboratory] to be checked up immediately before leaving England. Moreover, Evans, who took the original observations at Halley Bay, had also been to Shotover to become familiar with the working of the instrument and its maintenance. The annual variation of ozone at Spitzbergen [near the North Pole] was fairly well known at that time, so, assuming a six months difference, we knew what to expect.

"However, when the monthly telegrams from Halley Bay began to arrive and were plotted alongside the Spitzbergen curve, the values for September and October 1956 were about 150 [Dobson] units lower than was expected. We naturally thought that Evans had made some large mistake or that, in spite of checking just before leaving England, the instrument had developed some fault.

"In November the ozone values suddenly jumped up to those expect-

ed from the Spitzbergen results.

"It was not until a year later, when the same type of annual variation was repeated, that we realized that the early results were indeed correct and that Halley Bay showed a most interesting difference from other parts of the world. It was clear that the winter vortex over the South Pole was maintained late into the spring and that this kept the ozone values low. When it suddenly broke up in November both the ozone values and the stratosphere temperatures suddenly rose." (emphasis added).

#### Is There a 'Hole'?

The observed ozone hole in 1986 presented a greater depletion of ozone than was measured by Dobson, and it is this difference that scientists (as differentiated from the media) refer to as the real "ozone hole." The greater ozone depletion, however, can be accounted for by natural processes that deplete ozone under certain circumstances.

Many of the scientists now researching the ozone hole believe it is a natural phenomenon, with CFCs playing a minimal role, if any. This view is reflected in the special issue of the *Geophysical Research Letters* of November 1986 on Antarctic ozone depletion. In

an overview of the 46 scientific papers presented in the special issue, Mark R. Schoeberl and Arlin J. Krueger from the NASA/Goddard Space Flight Center state:

"Despite the number of public pronouncements, no clear link between man-made pollutants and ozone depletion over Antarctica has been established; indeed, a number of papers in this issue present serious alternatives to and constraints on the suggested chemical scenarios. . . .

"The appearance of the South Polar total ozone minimum and higher values at mid-latitudes in the spring has been observed since the late 1950s well before man-made pollutants could have had any important impact on the stratosphere."

Schoeberl and Krueger conclude their introduction with the following: "The mechanism behind the ozone hole is still unknown. However, a number of investigators suggest that a large part of the decrease in Antarctic total ozone and stratospheric temperature is the result of [a] small climatic shift in the upper atmosphere, and this region is simply mirroring changes in the lower atmosphere. . . . If a large part of the decrease . . . is shown conclusively to be simply due to a change

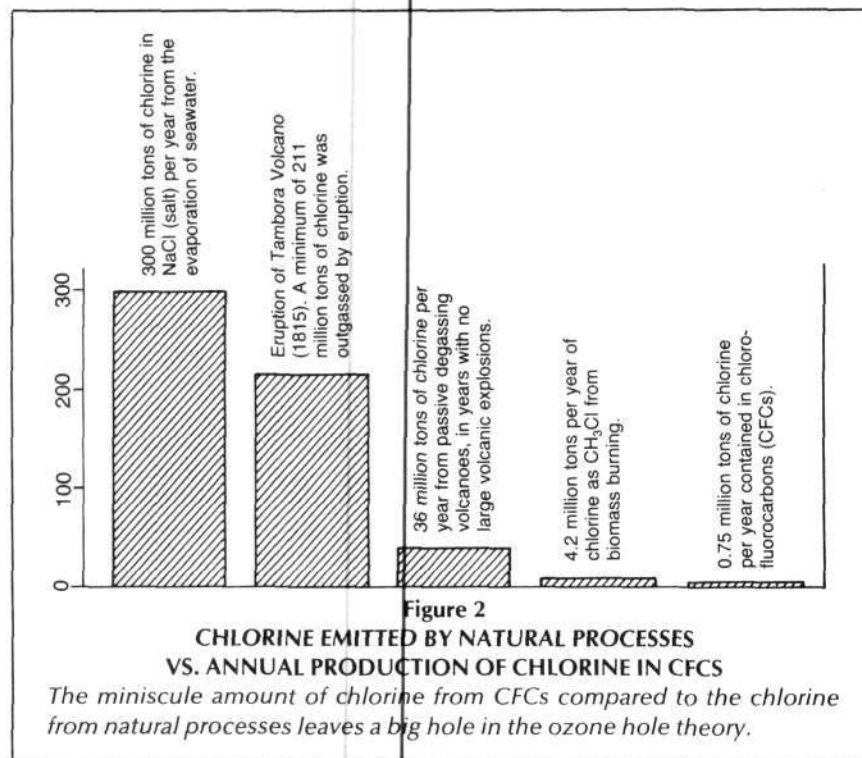

in the climate of the stratosphere, then it will become increasingly difficult to produce incontrovertible evidence of the chemical destruction of the ozone layer over the background natural variability."

#### Other Sources of Chlorine

The hypothetical scenario holds that CFCs, which are completely unreactive with ozone, rise to the stratosphere where they are broken by ultraviolet radiation, releasing chlorine molecules. These chlorine molecules then allegedly rush around like a Pac Man gobbling up ozone molecules.

The problem with this hypothetical scenario is that the amount of chlorine released into the atmosphere by CFCs is quite insignificant when compared to the amount of chlorine released by natural processes and biomass burning. The total amount of CFCs being produced around the world today is about 1.1 million tons annually, of which about 750,000 tons corresponds to chlorine in CFCs.

Compare this to other sources of chlorine:

- 300 million tons of chlorine come from evaporation of seawater, which contains salt, sodium chloride (NaCl). Large amounts of this chlorine reach the stratosphere through the pumping action of thunderstorms, hurricanes, and typhoons, which also break up the NaCl molecules.

- Between 11 and 36 million tons of chlorine come from the passive degassing of volcanoes in years with no great volcanic eruptions. Much greater amounts of chlorine are pumped into the atmosphere when there are large volcanic eruptions. For example, the great volcanic eruption of Tambora in 1815, pumped a *minimum* of 211 million tons of chlorine into the atmosphere.

At present CFC production levels, it would take mankind at least 285 years to produce as much chlorine in CFCs as that blown into the atmosphere in just a few weeks by the eruption of Tambora. There are no records of any human, animal, or plant extinctions in the early 1800s as a result of ozone depletion from this vast amount of chlorine.

- 4.2 million tons of chlorine gases are produced by the burning of biomass, largely as a result of primitive

## Why Are Du Pont, ICI Pushing Ban on CFCs?

The four companies that control 60 percent of the world supply of chlorofluorocarbons—du Pont, Allied Chemical, ICI (U.K.), and Atochem (France)—are now leading the campaign to ban CFCs.

Why are these giants so eager to phase out their product? Reports are that the old CFC patents are running out and that du Pont and ICI have already secured patents on a substitute that is more expensive. As one analyst in a leading London stock brokerage put it: "There are billions of dollars at stake. ICI is positioning itself to corner an extremely lucrative market."

People who know the chemical industry in developing countries say du Pont, ICI, and a tiny handful of companies realized a while back that their domination of the world market on CFCs was threatened. Countries like Brazil, Taiwan, South Korea, and certain OPEC countries are rapidly developing independent, nationally owned chemical industries that are becoming self-sufficient in CFCs and other basic chemicals.

"For these large companies, elimination of a few percent in their market share can destroy their entire price structure. These Third World producers have become a

serious threat to them on the margins, and that is critical," the London analyst said. He continued: "The ban on CFCs will be a big, big problem for especially Third World countries. The big chemical multinationals want binding legal sanctions internationally to enforce the ban. . . . They aren't about to let Third World producers take this market away from them."

According to U.S. government sources, du Pont—the U.S.-Canadian conglomerate controlled by Edgar and Charles Bronfman of Seagram's—played a decisive role in shaping the 1987 Montreal Protocol. "We had input into the Protocol," a du Pont spokesman said in an interview.

"In 1986, du Pont called for strict controls on CFC use. By 1988, we declared that we would phase out all CFC production by the end of the century." This is also ICI's timetable as well as the exact program adopted by the Helsinki monitoring conference.

ICI expects to charge five times as much for its CFC replacement—quite a substantial reason for a corporate giant to suddenly help the environmentalists ban a less lucrative substance.

—William Engdahl

slash-and-burn agriculture and the policy of the international banking agencies (the International Monetary Fund, for example) to force developing nations to burn wood and other biomass for fuel instead of developing the more efficient and energy-dense systems, like nuclear power.

Vast amounts of this naturally occurring chlorine find their way to the stratosphere through the pumping action of large storm systems and the jet stream, which pick up gases in the troposphere and advect them to the stratosphere. The role of storms is very important, because a great majority of

volcanic activity and biomass burning is occurring in areas of the world where the greatest amounts of atmospheric water vapor and gases are pumped up to the stratosphere and its ozone layer.

Specifically, the two greatest "stratospheric fountains" are found over the Amazon rainforest and the Indonesian archipelago. In 1985 and 1987, the Amazon Boundary Layer Expedition (conducted jointly by NASA and the Brazilian government) for the first time directly measured the magnitude of convective storm transport to

*Continued on page 19*

# AIDS As a Cross-Species Viral Transfer

by John Seale, M.D.

## EDITOR'S NOTE

*John Seale, a member of the Royal Society of Medicine and the British Royal College of Physicians, is a consultant in genito-urinary medicine in London and an authority on AIDS. This paper is adapted from a longer work that will appear in the Journal of the Royal Society of Medicine, Sept. 1989.*

*A full list of scientific references can be found in that publication.*

\* \* \*

The theory that the AIDS virus (HIV-1) has infected an isolated group of people in Africa for millennia is not scientifically credible, nor is the suggestion that the AIDS epidemic was ignited by the bite of a green monkey. It seems

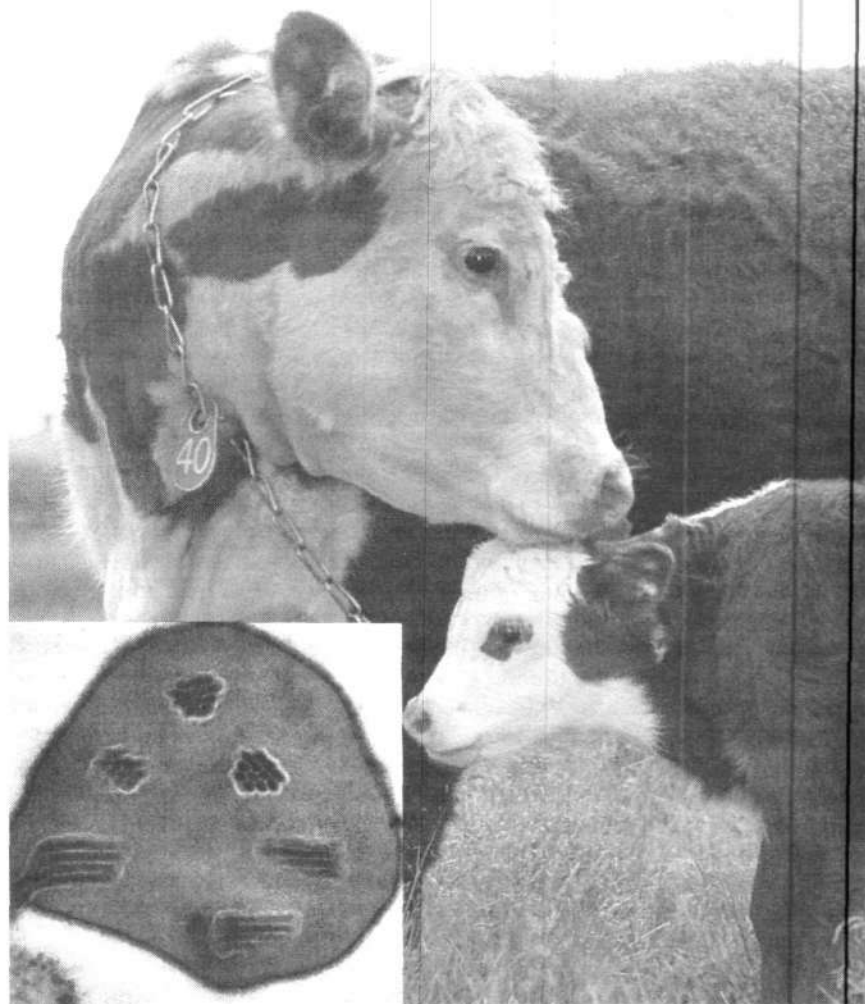

*New techniques in virology have increased the opportunity for cross-species viral transfer. Inset is a virus in cross section, magnified many thousands of times.*



*John Seale*

more likely that the AIDS epidemic is just one of the latest of several recent mammalian cross-species viral transfers, triggered by the techniques of virology, which subsequently spread out of control in the new host species.

Viruses that cross the species barrier to become established in a new mammalian host are often highly lethal. Cross-species transfer happens relatively infrequently in nature but new techniques in virology are rapidly increasing the opportunities for its occurrence.

The 1950s myxomatosis panzootics in rabbits were started deliberately. The 1977 canine parvovirus panzootic in dogs was probably accidental. The 1977 pandemic of H1N1 Type A influenza in humans, the ongoing bovine spongiform encephalopathy epizootic of British cattle, and the current morbillivirus epizootic in seals could all have been set in motion intentionally.

Several recent retroviral epizootics of AIDS-like diseases in primate research colonies seem to have been the unexpected, unpredicted, and unintended outcome of biological experiments. It is inevitable that further epidemics and epizootics of new lethal viruses will occur in the future. All outbreaks of new major viral diseases should in future be thoroughly investigated, as soon as they are identified, in an attempt to ascertain their origin.

### Species Specificity

Viral species tend to be restricted to the host animal species that they infect, or its close relatives. They have evolved to fill a particular ecological niche that they cannot readily leave, and they are typically not very pathogenic to their long-established host.

There are formidable obstacles preventing a virus crossing the species barrier to become established and



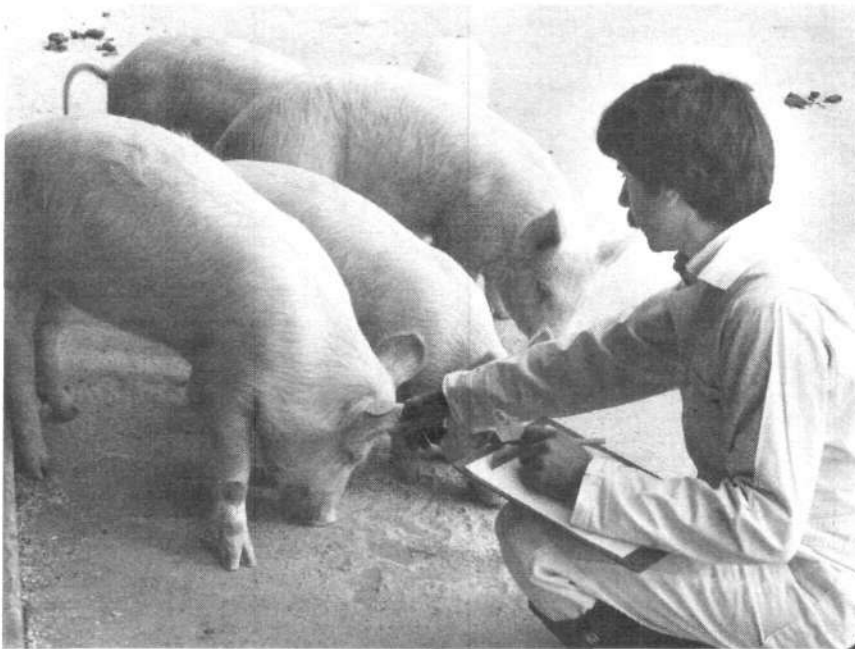

Agricultural Research Service/USDA

The African swine fever virus once killed 99 percent of pigs within two weeks of infection. As the virus spread to become enzootic in domestic pigs, strains evolved that were less lethal. Here, zoologist H. Ray Gamble, who developed methods for producing antigens for swine trichinosis.

persist in new species. The first hurdle is to reach and infect cells of a new host species and replicate within them. The second, far higher hurdle, is to achieve shedding of the virus in quantities adequate to regularly infect other individuals of the new host species. If this is not achieved the virus will die out in the new species. On the other hand, if it is successful, the virus in the new host species will adapt, evolve, and may become specific to its new host.

Many viruses that infect other animals and have also infected individual humans sporadically for millennia have still failed to become fully human-adapted by regular direct transfer from person to person. Many arboviruses readily infect humans when injected into them by infected insects, but they fail to be shed from humans in quantities adequate to infect other people directly. Rabies virus infects humans bitten by an infected animal, but fails to be shed and dies with the human host. These viruses have cleared the first hurdle but failed the second.

Other viruses clearly have been successful. Species-specific, acute viral infections of humans that are followed by life-long immunity, such as measles

and smallpox, cannot survive in an isolated population of less than about 200,000. They could not persist in small groups of hunting and gathering peoples. These human viruses must have evolved from viruses of other animals that have crossed the species barrier successfully, becoming specific to humans within the last few thousand years, after the foundation of cities.

#### Recent Cross-Species Transfers

There are several examples of well documented, spectacularly successful, crossings of species barriers in the 20th century by viruses affecting non-human mammals assisted by human action—whether by chance or by design. The movement of the domestic pig to Kenya brought it into close contact with its near relative the wart-hog (*Phacochoerus aethiopicus*) and its tick (*Ornithodoros moubata porcinus*). African swine fever virus, which causes a persistent but harmless infection of the wart-hog, was transferred to pigs with the help of ticks and has now been successfully established in them for 70 years. The initial epizootics killed 99 percent of pigs within two weeks of infection, but as the virus has spread to become enzootic in domes-

tic pigs in Africa, Europe, and America, strains have evolved causing persistent but less lethal infections.

The myxoma virus was used deliberately to infect rabbits as a means of pest control in Australia and Europe in the early 1950s. This virus has caused minor pathology in the South American forest rabbit (*Sylvilagus brasiliensis*) probably for millions of years, but when injected into the European rabbit (*Oryctolagus cuniculus*), initially killed 99.8 percent of them. The explosive panzootic spread across the continents was entirely dependent upon mechanical transmission provided by mosquitoes and fleas.

Myxomatosis was introduced into Australia's wild rabbit population by government decision, and into Europe's by the action of a single private citizen, Dr. P.F. Armand Delille. Now that evolutionary changes in virus and rabbit have greatly reduced mortality, attempts are being made to increase viral virulence by genetic engineering.

Canine parvovirus (CPV) appeared abruptly in dogs in 1977, and within a few months it became panzootic on all continents, causing an entirely new form of canine enteritis and myocarditis. Within a couple of years, a large section of the world's domestic canine population had been infected. Canine parvovirus is genetically very similar to the long-recognized feline panleukopenia virus (FPLV) for which many live modified vaccine viruses have been used. The dog virus is genetically even closer to some of the vaccine viruses than it is to the naturally occurring cat virus. Several virologists have suggested that canine parvovirus evolved "under selective growth conditions, for example in the course of deliberate or accidental adaptation of feline panleukopenia virus strains to replicate in canine cells" (Tratschin et al. 1982).

The epidemic was then ignited from a single source, possibly a contaminated vaccine injected into dogs. This has never been verified conclusively but is the most plausible explanation for this remarkable and explosive cross-species transfer from cats to dogs after millennia of domesticated proximity.

Bovine spongiform encephalopathy (BSE) has appeared since 1985 on more than 1,000 farms scattered throughout

Britain as an entirely new disease of cattle that has not been reported from other parts of the world. It is uniformly fatal and caused by an atypical virus similar to those that cause scrapie in sheep and kuru and Creutzfeldt-Jakob disease in humans. The epizootic has the characteristics of a cross-species transfer of a new, slow virus disease originating from a single source.

It has been suggested that the outbreak may have been caused by feeding cattle with scrapie-contaminated bone meal prepared from the carcasses of sheep. This is similar to the suggestion that the spongiform encephalopathy of mink, which appeared about 40 years ago, had its origin in the feeding of carcasses to mink on commercial mink farms. However, 18,000 sheep in Britain were infected with the scrapie virus in 1935, when it accidentally contaminated a batch of louping-ill vaccine, and most experimental cross-species transfers of these atypical viruses have been achieved only by inoculation. Precisely how this virus jumped from sheep to cattle is still not known, but clearly it is related to human actions.

The precise origin is also unknown for the new morbillivirus of common seals (*Phoca vitulina*), which in 1988 started a highly lethal epizootic in the Baltic and North Sea. It had been preceded, by a few months, by the appearance of a similar virus infecting the freshwater seals (*Phoco siberica*) of Lake Baikal in the Soviet Union.

Morbilliviruses do not appear to be enzootic in sea mammals, and clearly the virus is spreading in seals as a "virgin-soil" epizootic. It is closely related to canine distemper virus but is even closer to rinderpest virus of cattle. Modified live morbilliviruses have been used for many years to vaccinate humans against measles, dogs against distemper, and cattle against rinderpest.

There is no difficulty in principle in modifying a morbillivirus by artificial selection to kill seals, though igniting a panzootic is much more chancy. Seals, like rabbits, have been culled legally as an economic pest for decades. The fact that myxomatosis panzootics in rabbits were started deliberately, and justified economically, is not evidence that the seal epizootic

was started likewise; but it is a possibility that cannot be entirely ignored.

#### Influenza

Influenza Type A is particularly interesting as the only major virus of humans that regularly and naturally passes to and fro across species barriers. Many mammals and birds are host to numerous subtypes of influenza A that often jump species. Reassortment of the genes of an influenza virus from humans with those from another animal species was the source of the abrupt appearance of new subtypes that produced the pandemics of 1918, 1957, and 1968.

The unexpected reappearance on May 4, 1977, in Anshan in northern

---

**"The AIDS epidemic may be just one of the latest of several mammalian cross-species viral transfers triggered by the techniques of virology, which subsequently spread out of control in the new host species. It is certain that in at least one instance the creation of the panzootic was deliberate."**

---

China of the H1N1 subtype (which had been extinct in humans for more than 20 years), with a molecular structure identical to the virus that caused an influenza epidemic in 1950, has been described by scientists as mysterious (White and Fenner 1986). However, several virologists postulated that the 1950s strain, which along with many others had been kept deep-frozen in laboratories for 27 years, had escaped and, according to a paper in the journal *Virology*, the epidemic "resulted from a man-made event" (Kendal et al. 1978).

According to the journal *Nature*, "Chinese and Soviet scientists have denied [this] possibility as the origin of the . . . epidemics in their countries" (Ennis 1978), and so the mystery remains unsolved. Nevertheless, artificial freezing of this rapidly evolving

RNA virus and its subsequent release from suspended animation remains the only plausible scientific explanation for its reappearance genetically unchanged 27 years later.

#### Retroviruses (Oncornaviruses)

Retroviruses of the cancer-causing subfamily, oncornavirus, in experimental situations often readily infect cells from different species in cell culture. When a retrovirus first infects intact animals of a new species, the virus is not integrated into the germ line; it is said to be *exogenous*. Its continued survival in the new species depends upon infectious transmission.

With time, if successful, the virus may be incorporated into the DNA of the germ line, enabling transmission to take place genetically within the host; it is then said to be *endogenous*. When cross-species infection of a retrovirus is dependent only upon chance and natural selection (as opposed to artificial selection in the laboratory), cross-species infection appears to be a rare historical event.

An endogenous Type C retrovirus is present in all species of baboon, and its precursors have persisted in their ancestors for at least 40 million years. About 3 million years ago, somewhere in North Africa or the Middle East, an ancestor of the domestic cat was infected with the baboon retrovirus, and its descendants are present today in all cats as the endogenous feline retrovirus RD-114, which is now harmless to its feline host.

Also, about 1 million years ago, an endogenous Type C retrovirus that had been present in rats for at least 5 million years infected an ancestral cat. Its descendants persist today as the feline leukemia virus, which commonly causes immune deficiency in cats.

Between 5 and 10 million years ago, an endogenous Type C retrovirus from a mouse infected the common ancestor of the domestic pig. More than 30 million years ago, an endogenous Type C retrovirus from the common ancestor of lions, leopards, jaguars and domestic cats infected the ancestor of the macaque.

Set against this geological time scale, some endogenous retroviruses have infected other species very much more recently. The gibbon ape leukemia virus is an infectious retrovirus

that caused an epidemic of leukemia in gibbons in a research colony in Thailand in the early 1970s. The virus has since been detected in several colonies of captive gibbons, but it is not yet known if wild gibbons are infected, which, according to a leading authority, "is an extraordinary oversight in our research efforts" (Deinhardt 1980). The gibbon virus originated from a virus of mice, and the cross-species transfer appears to be very recent. It possibly occurred, unintentionally, in the 1960s, when gibbons were inoculated experimentally with tissues from other species—including humans.

An infectious Type D retrovirus is the cause of one of the two AIDS-like diseases that recently were discovered in macaque monkeys. The virus descended from a close relative of the endogenous Type D retrovirus (PO-1-Lu) of the spectacled langur. The disease was first observed as an epizootic among macaques in a primate research colony in 1969, and sporadic episodes have occurred subsequently. Although the langur virus may have infected macaques in the wild, this has not been verified, and the cross-species transfer may have occurred only after experimental cross-species inoculation of cells and viruses in primate research colonies.

#### Retroviruses (Lentiviruses)

The lentiviruses are members of a non-cancer-causing subfamily of ret-

roviruses, of which HIV-1, the cause of AIDS in humans, is the most notorious. All known lentiviruses are exogenous, being transmitted by infection and not in the germ line. The existence of endogenous, genetically transmitted lentiviruses has not yet been demonstrated. These viruses are highly species specific, readily transmissible only to closely related species of mammal.

Maedi-visna virus of sheep, the prototype lentivirus first grown in cell culture in 1959, will cross-infect the goat. The genetically closely related caprine encephalitis arthritis virus of goats will cross-infect sheep. Equine infectious anemia was, in 1904, one of the first diseases shown experimentally to be caused by a virus. Its virus will cross-infect donkeys and mules. The recently discovered lentiviruses of cattle and cats have not yet been shown to cross-infect other species.

No successful experimental infection of small laboratory animals with any of these lentiviruses has yet been reported, in spite of numerous attempts over many years. Infection of cells from other species with these lentiviruses has proved difficult or impossible, although there have been reports of infection of human cells in tissue culture by maedi-visna virus and from sheep and the lentivirus of cattle.

Coming closer to home with the primate lentiviruses, HIV-1, the AIDS vi-

rus in humans, will infect chimpanzees, when injected with the virus or with blood from human carriers, though none has yet developed any significant disease. All attempts to infect other primate species have failed. Within the last few months, infection with HIV-1 of rabbits with chemically induced peritonitis has been reported. On the other hand, infection of cell cultures from many primate species has been achieved, in spite of failure to infect intact animals.

HIV-2, a cause of AIDS in West Africa, infects a wider variety of primate species than HIV-1. Baboons and macaques have both been infected, experimentally, and some macaques have become immune deficient.

There is a lentivirus, very similar to HIV-2, that started an epidemic of AIDS among macaque monkeys in a primate research colony in the late 1970s. The virus has not been found in macaques in the wild, which all come from Asia. However, an almost identical virus infects a high proportion of wild sooty mangabeys—which come from Africa—in which it causes no disease; but when injected into macaques causes AIDS.

The original, apparently spontaneous epidemic of AIDS in macaques in the research colony seems to have been the unexpected, and unintended, result of injecting tissues from mangabeys into macaques in the search for causes of cancer.

The only other lentiviruses so far identified in other primate species are from the African green monkey (SIVagm) and the mandril (SIVmnd). They appear to be nonpathogenic to their hosts and have not yet been transmitted to other species.

Available evidence strongly suggests that the primate lentiviruses of sooty mangabeys (SIVsm), African green monkeys (SIVagm), and mandrils (SIVmnd) are naturally occurring, species-specific viruses that have infected their hosts harmlessly for millions of years and evolved in concert with the evolution of their hosts. By contrast, HIV-2, which is closely related to the virus found in mangabeys and macaques, seems to have infected humans only recently, probably after simian blood or tissues were injected into humans by chance, or by design.



Linda Ray

The prototype lentivirus maedi-visna of sheep was first grown in a cell culture in 1959.

### The Case for Cross-Species Transfer

HIV-1 in humans also has the hallmark of a virus that has only recently infected its host—like African swine fever in pigs, myxoma virus in rabbits, canine parvovirus in dogs, scrapie "virus" in cattle, and the new morbillivirus in seals. The theory popular among many molecular biologists—that HIV-1 has been endemic, and largely non-pathogenic, in an isolated group of people in Africa for millennia—(Gallo and Montagnier 1988; Gonda 1986) is not scientifically credible.

No precursor genetically nearly identical to HIV-1 has been found in any other species. The nucleotide sequence of HIV-1 is little closer to HIV-2 than it is to the naturally occurring primate lentiviruses of green monkeys, mangabeys, and mandrils. It is possible that a naturally occurring lentivirus much closer genetically to HIV-1 may yet be discovered in some other species.

On the other hand, HIV-1 may have evolved rapidly from known animal lentiviruses replicating in the highly artificial, selective conditions of serial passage in human cell cultures. It is highly relevant that all lentiviruses so far identified in nonhuman primates (African green monkeys, macaques, sooty mangabeys, and mandrils) have been obtained by culturing them, not in cells from their natural host species, but in human cells.

It would appear that the AIDS epidemic may be just one of the latest of several mammalian cross-species viral transfers triggered by the techniques of virology, which subsequently spread out of control in the new host species. It is certain that in at least one instance the creation of the panzootic was deliberate.

It is inevitable that further epidemics and epizootics of new lethal viruses will occur in the future. All outbreaks of new major viral diseases should in future be thoroughly investigated as soon as identified, in an attempt to ascertain the origin. The attitude of many scientists, that there is no importance in attempting to track down the origins of the AIDS epidemic, is both arrogant and highly irresponsible. It is an attitude that implies that all epidemics are still natural occurrences, or what used to be called acts of God.

This attitude misses the point that in the new age of biotechnology, not only can major lethal pandemics occur as a result of laboratory accidents, but also they can be started deliberately. As some molecular biologists seem to perceive themselves in the role of gods, it is important for the health of the rest of us—who are mere mortals—that we keep an eye on their activities.

### Selected References

- F. Deinhardt, 1980. "Biology of Primate Retroviruses," in: *Viral Oncology*, G. Klein, ed., 357.
- F.A. Ennis, 1978. "Influenza A Viruses: Shaking Out Our Shibboleths," *Nature* 274:309.
- R.C. Gallo and L. Montagnier, 1988. "AIDS in 1988," *Scientific American*, Oct., 25.
- M.A. Gonda, 1986. "The Natural History of AIDS," *Nat. Hist.*, May, 78.
- A.P. Kendal, G.R. Noble, J.J. Skehel, and W.R. Dowdle, 1978. "Antigenic Similarity of Influenza A (H1N1) Viruses From Epidemics in 1977-1978 to 'Scandinavian' Strains Isolated in Epidemics of 1950-51," *Virology* 89:613.
- J. Tratschin, G.K. McMaster, G. Kronauer, and G. Siegl, 1982. "Canine Parvovirus: Relationship to Wild-type and Vaccine Strains of Feline Panleukopenia Virus and Mink Enteritis Virus," *J. Gen. Virol.* 61:33.
- D.O. White and F. J. Fenner, 1986. *Medical Virology* (London: Academic Press), 114-118.

## Ozone Hole

Continued from page 14

the stratosphere. They discovered that individual thunderstorms in the Amazon were transporting 200 megatons of air per hour, of which 3 megatons were water vapor, in the process releasing 100,000 megawatts of energy into the atmosphere.

On average, 44,000 thunderstorms occur daily, mostly in the tropics, which gives an idea of the enormous amount of gases that are transported through the atmosphere every day.

The scientists who have been spreading scare stories about CFCs have carefully avoided addressing the issue of these naturally occurring chemicals, which, if their claims are correct, should also deplete the ozone layer. In this they have had great help from the antitechnology news media. What we need is not more Chicken Little stories, but some serious scientific work to determine the real nature of the biosphere.

If a journey around the world changes a person... then a journey 200 times around the world at the speed that a spaceship travels changes a person even more. Joe Allen, astronaut.

★★★★ 1/2 Buffalo Evening News  
"EXHILARATING, BEAUTIFUL VIDEO" - Providence Journal  
"...brings the feel of living and working in space to the earthbound public." - Science Books and Films

# SEVEN DAYS IN SPACE

(A WEEK ABOARD SPACE SHUTTLE "DISCOVERY")

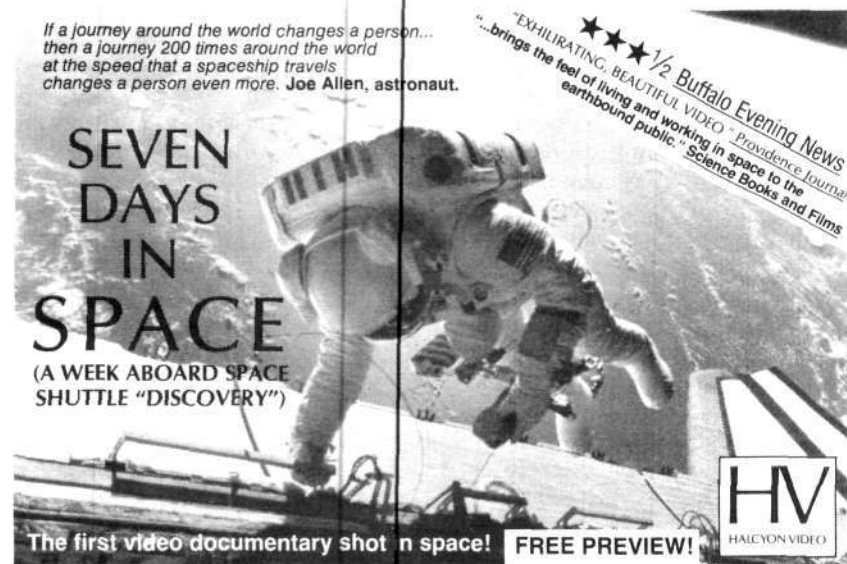

The first video documentary shot in space! FREE PREVIEW!

HV HALCYON VIDEO

Launch on a tour of the Space Shuttle, guided by the astronauts and controllers of *Discovery* on the mission that rescued and returned to Earth two defective communications satellites. Become weightless, deploy new satellites, gaze back at your planet, strap on the Manned Maneuvering Unit and take the ride men have dreamt of for thousands of years! **88 minutes of being there! 20 pages of background notes.** Narrated, in part, by Rick Hauck, the commander of *Discovery* in October, 1988.

We'll send you a video-highlights preview cassette for a refundable deposit of \$5.00. After viewing the preview, return it for \$5.00 off the regular \$32.95 price, or simply ask us to return your deposit.

**Alternatively, order at the full price before Christmas, and we'll include a real gift from space!**

order by check or m.o. for \$32.95 (ppd.) to:  
**HALCYON FILMS AND VIDEO**  
110 BEACH RD. ROOM 400  
KING'S PT., N.Y. 11024

or call 1-800-426-0582

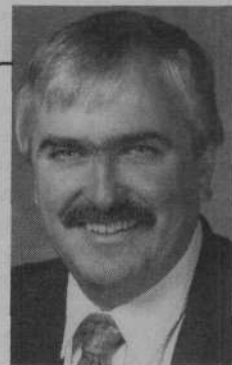

# The Truth about Solar Energy: It Costs Too Much

by Dr. Michael Fox

Solar energy has been considered a potential limitless supply of energy since the time of Archimedes, and the idea has been revisited from time to time by various scientists, including the French government about 100 years ago. What these scientists discovered is exactly what today's solar scientists have found: Solar energy is too diffuse, too intermittent, and too costly. To hold out the hope that it will provide a large supply of bulk energy is really to mislead an uninformed public with promises that cannot be fulfilled.

Today's costs for solar voltaic systems are more than \$15,000 per kilowatt, compared with an estimated cost of a new coal plant of \$1,100, and for a nuclear plant of \$1,800 per kilowatt. The most optimistic R&D goal for solar cells—a goal that has yet to be achieved—would bring capital costs down to about \$4,000 per kilowatt. This still is a price that has already been deemed too expensive for any utility.

## Diffuse and Unreliable

Coming into the upper atmosphere, solar energy flux is in the neighborhood of 1,000 watts per square meter. This varies from latitude to latitude, season to season, day to day, and morning to night. A billion-dollar research effort will not change these values; they are fixed by physical law including energy output from the sun. One thousand watts per square meter is a good middle-range value to discuss. As the solar energy passes through the atmosphere and toward the surface of the Earth, part of it is absorbed to drive the weather systems around the world.

Because solar energy is involved in tornados, hurricanes, cyclones, evaporation of seawater, and powering the whole weather system, it is converted away from being available for electri-

cal energy. Another large fraction of solar energy is reflected back into space. (That is why the Earth is visible from the Moon.)

By the time it gets to the surface of the Earth, somewhere around 300 to 350 watts per square meter is measurable at midday (two thirds has already been lost). Even if a photovoltaic system is 20 percent efficient, we are talking, at best, of 70 watts per square meter of electrical energy. This energy is low voltage direct current, and therefore requires additional electronic equipment to convert to alternating current and increase it to 120 volts.

This is an exorbitant way of getting 70 watts of energy! Remember that even this 70-watt case occurs only at high noon on a sunny day. Therefore conventional backup systems are also required. If the backup electrical system uses batteries, this means that hundreds of thousands of batteries will be needed to store the energy required on a cloudy day.

## The Environmental Impact

Batteries also have a finite lifetime. They wear out—and become waste. So solar energy does create its own waste, such as the disposing of hundreds of thousands of batteries per year or the



*Fox: It's a cruel misrepresentation of the facts to hold out the hope that solar is a viable source of bulk supplies of energy.*

decommissioning of gallium arsenide collectors (one of the materials being considered) by the ton, and these contain arsenic.

Someone once said that when you make energy by any method, you make a mess. Given that, and given that electrical energy is becoming more and more the preferred energy form, we should emphasize electrical production methods that minimize the mess we make. Nuclear energy, BTU for BTU, is impossible to beat, and that's an environmental fact. No one objects to the use of solar energy for heating water in southern latitudes or for operating remote facilities. But it's a cruel misrepresentation of the solar energy facts to hold out the hope that it's a viable source of bulk supplies of energy.

To say that solar is an environmentally benign source of bulk energy also misleads the uninformed public. The largest environmental impact of solar energy is a substantial increase in the land use. Large amounts of land are already required to meet energy needs, such as that flooded behind dams. And solar energy requires about 30 times more land per unit of power delivered than does a nuclear or coal power plant. Covering square miles of land with solar collectors would drive the cost up to astronomical heights.

Because the energy that comes from the Sun is very, very diffuse and intermittent, large collectors are needed, which requires huge amounts of concrete, steel, glass, re-bar, and other construction materials to build the equipment to capture the energy source. This means higher costs—and more waste.

For example, cement factories convert carbonate-type rock to cement, a calcium oxide, and in this process drive off thousands of tons of carbon dioxide. Thus, even when using concrete, as one would in a solar facility, it would have a measurable impact on the inventory of carbon dioxide in the atmosphere. This is not unique to solar energy, of course, but neither should it be ignored.

Because solar energy is so diffuse and so much land must be covered, the amounts of material come to as much as 15 times more concrete and steel than are required by a nuclear plant or a coal plant of equal capacity. Thus, a large commitment to building solar facilities would have a substantial impact upon the environment without a commensurate amount of energy produced. It does not matter whether one discusses one 1,000-megawatt solar facility or one million smaller 1,000-watt facilities. The area requirements and material requirements are nominally the same. There obviously would be some benefits of large scale for the former case.

There are many solar facilities scattered around the United States. By and large these facilities have been shut down by their owners because they are a real maintenance or cost headache—keeping the piping from leaking, keeping the solar collectors from getting dusty and dirty (pigeons have a fascinating way of ruining the energy absorption of these collectors). Some of these hidden costs are huge.

#### **'Ask the Man Who Owns One'**

These are some of the facts of life that are discovered when one "asks the man who owns one." Unless I misread the American public, and their increasing appetite for electricity, I don't think Americans want to spend the rest of their lives dealing with large maintenance and cost problems.

Another good source of real information on solar energy is the scientists who do the actual work. Solar scientists Aden and Marjorie Meinel at the University of Arizona, for example, discovered in the mid-1970s what a lot of us engineers already knew: that the auxiliary costs in solar energy—such as the installation, maintenance, financing, replacement costs—drove the total cost to extraordinary heights.<sup>1</sup> The Meinels said that even if they gave people their solar panels free, these other costs would make them unacceptably expensive.

Exactly how expensive was measured by a government study in 1980 by the General Accounting Office, which compared 238 solar facilities with alternative energy sources available at the site—electrical energy, oil, natural gas, and others.<sup>2</sup> In no situa-

tion did the cost of these solar demonstration facilities come within a factor of 7 of the energy sources they replaced.

The reason that solar has failed to become a viable source of energy is not a lack of research. There has been an enormous amount of research in the last 10 years—and in fact in the past 100 years. The truth is that solar energy bumps up against the engineering realities and physical laws; it is so diffuse and so intermittent that it requires a more reliable energy source as a backup.

#### **The Barstow Fiasco**

Let's look at the example of southern California's Barstow Power Tower, a solar facility in the desert. In its initial phase, it was designed to produce solar electrical energy—a 10 MW plant. One of the engineers overseeing the performance of that facility told me that on an annual basis the Barstow plant is a net consumer of energy. In other words, the plant cannot provide all of its own energy needs for the year. Unfortunately, that brutal engineering fact was discovered by its proponents after the plant was constructed.

Before this lesson was learned, many engineers had quietly expressed their concerns about spending taxpayers' dollars on such a facility, when the costly outcome could already be calculated. But now it has been demonstrated, and the Barstow management has quietly altered its purpose. The demonstration effort has been changed: Instead of producing electricity, they are examining ways of using process heat directly—generating high-temperature fluids and pumping these around to provide process heat.

Barstow was a spectacular engineering feat, but predictably it was *not* a net energy producer. We've got to learn to ask the right questions.

#### **Remote Solar Systems**

There may be some economical uses for solar energy. In eastern Washington, which is a desert with six to eight inches of rain a year, there are some solar facilities. Many of them don't work; a few of them do. The ones that do work are used primarily to operate railroad crossings. The reason the solar facilities work in this instance is one of unusual economics. We can either build one of these solar devices

# "THE SUN OF MAN"

*A one-hour documentary on nuclear fusion.*

Featuring Andrei Sakharov

## Available on videocassette

For tape orders and information  
please write or call

**New Jersey Network  
Program Catalog Dept.  
1573 Parkside Avenue  
CN777  
Trenton, NJ 08625-0777  
609-530-5180**

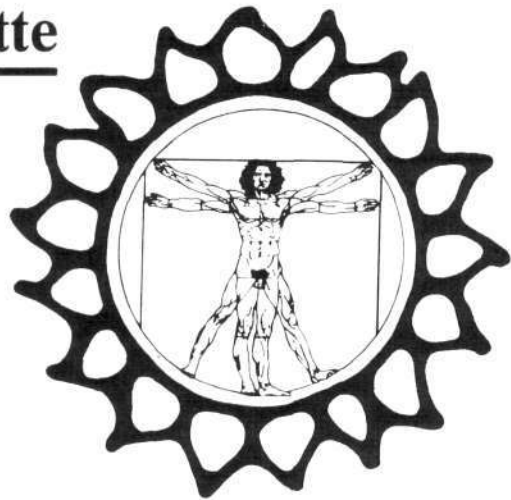

for \$30,000, or run an electrical power line out 25 or 30 miles into the desert for \$200,000.

In cases like these, it pays to have solar energy running the railroad crossing. But even in sunny eastern Washington, a large battery system is needed for storage for operating on cloudy days and during the night.

Another situation where solar seems to be viable is for the production of high-temperature water during the summer. This is favored in the lower latitudes, such as Arizona and southern California. Even there they typically have an electrical backup system to provide heated water when the solar system fails. Maintenance and repair costs are measurable.

The truth is that we must not hold out the hope that solar energy is going to provide any more than small amounts of energy for remote locations. Many of us view solar energy the way we would a crippled child. You might love it totally, but you know deep inside it's never going to play big league ball.

*Dr. Michael Fox, who holds a doctorate in physical chemistry from the University of Washington, has 24 years experience in the nuclear field at Hanford, Washington, and the Idaho National Engineering Laboratory.*

### Notes

1. The Meinels documented solar economics in great detail in testimony before hearings of the House Committee on Government Operations, Subcommittee on Environment and Natural Resources, 95th Congress, 1st Session, pp. 1403-30 (1977).
2. Washington, D.C.: General Accounting Office, (EMD-80-41), April 15, 1980.

## Colliding Beam Fusion

*Continued from page 10*

ed to make net energy. The system is to be based on advanced fusion fuels, like deuterium-helium-3 and proton-boron-11. These reactions primarily generate charged particle products that can be easily collected in the system and directly converted to electricity at better than 95 percent efficiency. (In today's power sources, about two-

thirds of the energy is waste heat.)

Detailed reactor studies indicate that the system will provide an extremely clean, cheap, small and power-dense source of electricity, capable of rapid development.

At the symposium, both Seaborg and Admiral Elmo Zumwalt called for a new "Atoms for Peace" policy based on existing nuclear fission technology and new fusion energy systems.

Zumwalt noted the particular flexibility of the colliding beam technology for defense as well as civilian uses. "The U.S. Air Force has seen that it is almost without equal for a space power plant," Zumwalt said. "Flexible ship and vehicle propulsion and space power are important for military reasons, but ever so much more so for peaceful purposes. . . . Energy shortages in the less developed countries starve not just economic but also human development. Just as energy shortage has been a factor in military insecurity, energy inequality is a direct factor in economic instability."

—Charles B. Stevens



## The Apollo Project of the Golden Renaissance

# Brunelleschi's Dome

*The magnificent dome of the Florence Cathedral embodies the achievement of Renaissance science—man's increasing dominion over nature—and of the individuals whose political battles made that Renaissance possible.*

by Nora Hamerman and Claudio Rossi

**T**he soaring dome of Florence Cathedral, built more than 550 years ago by Filippo Brunelleschi and intended to last for 1,000 years, is now on a course toward self-destruction. The dome, which stands as the greatest symbol of the Renaissance rediscovery of science, is endangered by the irrational blundering of a generation that no longer grasps or sympathizes with the principles by which it was built.

The major cracks in the dome are widening, increasing the dome's outward thrust at the base to potentially disastrous levels. According to the Florentine architect Lando Bartoli, author of two books on Brunelleschi, this is the result of an arbitrary step taken in 1979, when the 48 staging

holes that Brunelleschi left at the base of his Cupola were filled with reinforced cement, in order to support a system of trusses for the restoration of the 16th-century frescos decorating the inside of the dome. These large holes (60-cm square) had been left open by Brunelleschi on the inside of the dome and covered on the outer shell. Since they were stopped up a decade ago, the normal seasonal process of expansion and contraction of the masonry has been blocked, because the masses no longer have room to expand into these fissures. Despite this fact, Bartoli's public campaign, begun in 1985, to remove the cement from the holes has been greeted with evasions even more shockingly irrational than the original action.

Brunelleschi's dome, known in Italy as the Cupola, or "Cupolone" (giant cupola), came into being as a national mission by the city-state Republic of Florence, which was

*Panorama of Florence with the cathedral dome and Giotto's Belltower at the center.*



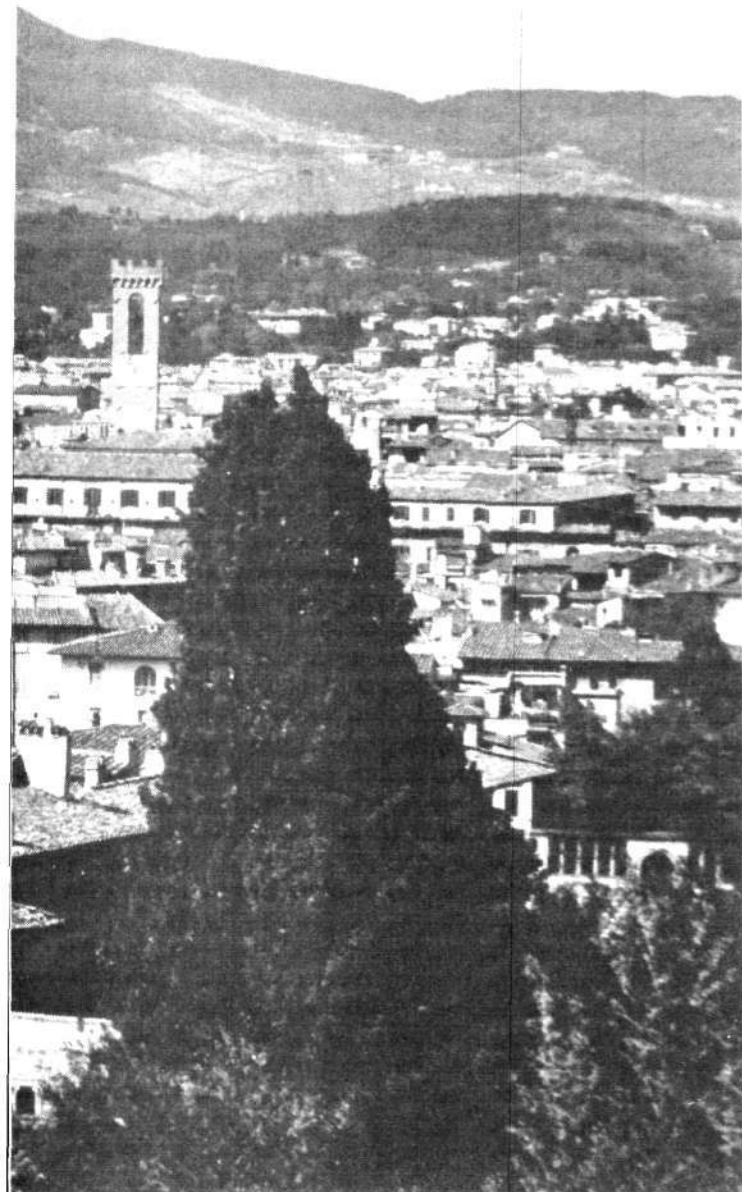

Scala Art Resource

committed to building this monument for more than a century, even before Brunelleschi himself was born. Although a series of plans to execute this work was debated in painstaking detail, never for a single moment did the Florentines doubt the wisdom of the project of a lofty dome spanning an octagon 42 meters in diameter, or doubt their ability to resolve the huge technical problems the project involved.

It was under Brunelleschi's newly completed dome, exactly 550 years ago in 1439, that a proclamation was made unifying the Eastern and Western Christian churches and ending the 400-year-old great Schism (see box). From then on, the principle of the necessity of scientific progress as the basis of government, so dramatically embodied in the dome, became an international organizing principle. This very principle, fostered by a unique combination of social, political, and technical conditions in the Florentine Republic

## Brunelleschi and the Florence Cathedral: A Chronology

- 1294: Project to rebuild the Cathedral of Florence, Santa Reparata, is begun, under Arnolfo di Cambio
- 1357: First documented mention of plans for a dome, 37 meters in diameter.
- 1367-1368: Committee of Artists wins factional battle for design of octagon with a 42-meter internal diameter.
- 1402: Brunelleschi comes in second in contest for design of Baptistery doors, after fellow goldsmith Ghiberti; begins serious studies of architecture.
- 1410 (ca.): High octagonal drum of dome is constructed.
- 1414-1418: Council of Constance unifies papacy, elects Martin V (Oddo Colonna), establishes Councils as ongoing institution. Medici family of Florence become chief papal bankers.
- 1418: Florence Cathedral Works (Opera del Duomo) declares contest for vaulting the octagon without centering.
- 1420: Brunelleschi's project is declared contest winner and work begins.
- 1421: Brunelleschi wins first recorded monopoly patent (for design of a barge to transport marble) granted by maritime affairs minister Cosimo de' Medici.
- 1425 (ca.): Masaccio, a young collaborator of Brunelleschi, paints "Trinity" in S. Maria Novella, Florence, displaying Brunelleschi's architectural design and scientific perspective.
- 1425: Brunelleschi elected to be one of the priors, the highest Florentine public office (two-month term).
- 1425-1426: Giovanni di Gherardo da Prato attacks Brunelleschi publicly, says dome violates the original plan and will collapse.
- 1431: Brunelleschi wins a second contest, for the design of the lantern of the dome.
- 1433: Brunelleschi is briefly imprisoned by enemies but then freed. Cosimo de' Medici is jailed by political rivals, the Albizzi family; escapes to Venice to avoid being killed.
- 1434: Medici return to Florence and assume substantial, although unofficial, political power.
- 1435: Alberti's *On Painting*, the first scientific book on the subject, explains perspective; dedicated to Brunelleschi.
- 1436: Dome completed up to the lantern; Cathedral is dedicated by Pope Eugene IV, then residing in Florence.
- 1437: Nicholas of Cusa, at Council of Basel, rallies to cause of Pope Eugene and undertakes mission to Constantinople to bring Patriarch and Emperor to Italy for Council.
- 1438: Ecumenical Council of Eastern and Western Churches convenes in Ferrara in northern Italy; Nicholas of Cusa soon departs for Germany; Council is forced to move to Florence after a few months, to avoid the plague. Costs are borne by the Medici family.
- 1439 (June): Council of Basel excommunicates Pope Eugene.
- 1439 (July): Council of Florence ends the Schism with proclamation of "Laetentur Coeli" under the dome of Florence Cathedral. Council continues until 1443, as other Eastern churches sign the same document.
- 1446: Brunelleschi dies, is honored by burial in Cathedral.
- 1461: Lantern of Florence Cathedral is completed and surmounted by gilded ball and cross.
- 1474: Sundial of Paolo Toscanelli installed in lantern of dome.
- 1492: Fifty years after the closing of the Council of Florence, Columbus lands in America.

lic of Brunelleschi's era, is today under concerted assault by the insurgent Malthusian movement, which might be glad to see such a proud monument to man's dominion over nature crumble to dust.

A project like the Cupola could not be built today without a reversal of the policy of politically backing the enemies of science who oppose progress in the name of "environmentalism." The recorded objections of Brunelleschi's opponents strike the same "sour notes" (the metaphor is Brunelleschi's own) as those of the irrational foes of nuclear power and the Strategic Defense Initiative today.

Filippo's irascible personality and "authoritarian" behavior during the project became legendary. By standardizing decorative details, and even taking charge of bringing food

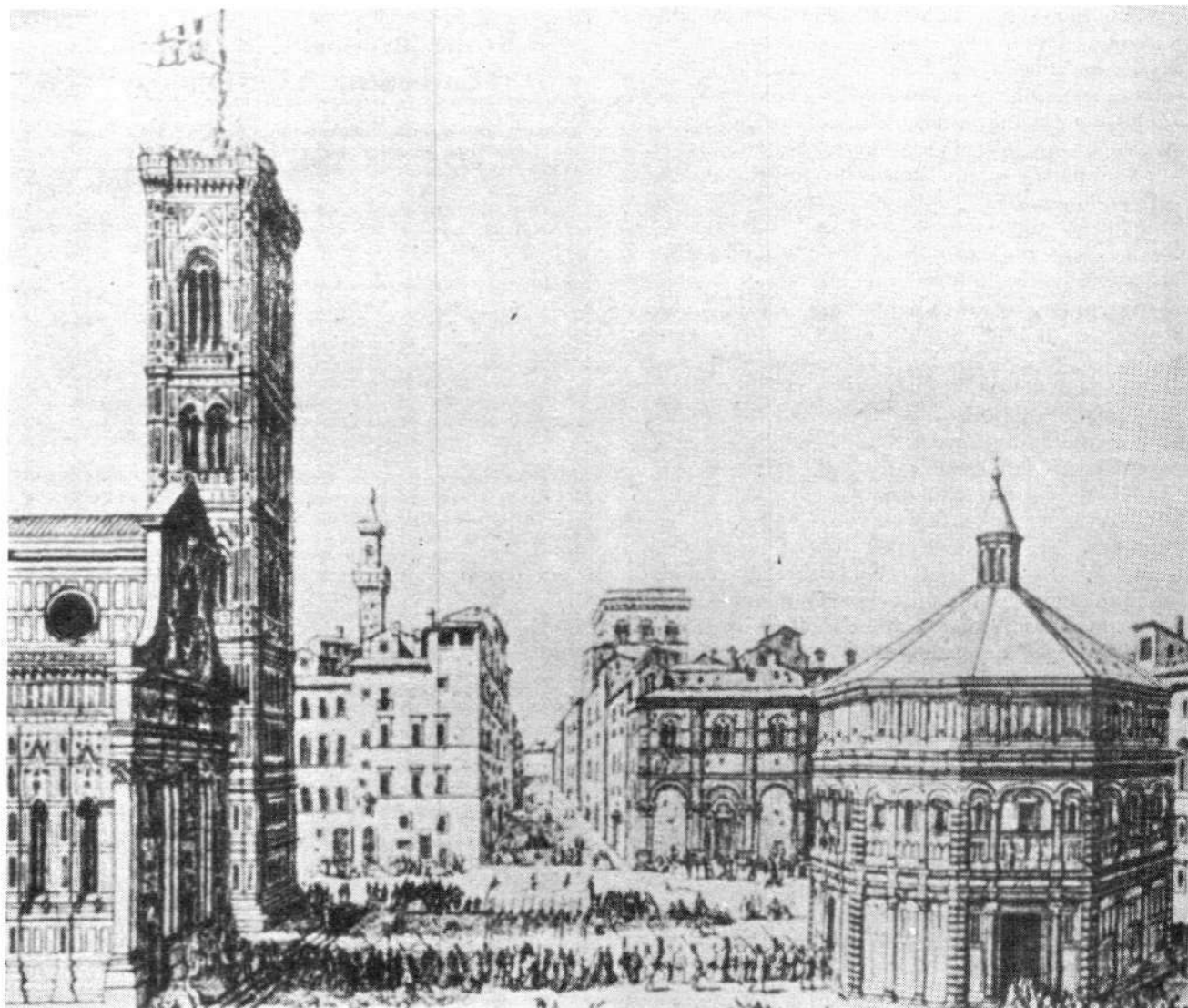

*The Florence Cathedral Group, a masterpiece of urban design created in the 1300s and 1400s. The construction projects shown in this 18th century engraving were exhaustively debated, but no one ever doubted the wisdom of the grandiose plan. The somewhat exaggerated perspective portrays the Baptistery facing the facade of the cathedral and Giotto's Belltower and looks toward the other pole of civic life, the square around the Priors' Palace (the tower in the background).*

to the work site, Brunelleschi anticipated certain methods of modern industrial capitalism. He sought, and obtained, monopoly patents for his inventions. He invented special hoists to save labor and horsepower. He played extravagant practical jokes on those who refused to understand—forcing them either to make a conceptual breakthrough, or as in the case of the famous carpenter “Grasso,” to flee and join the army. His opponents even tried jailing him at the height of the project, on the pretext of nonpayment of guild dues, but this tactic was foiled. As a result of his development of projective geometry, it became theoretically possible to conceive a building in one hemisphere of the world and construct it in another, a discovery with implications for the reproduction of knowledge and potential population growth as vast as the invention of printing in the same century—a comparison made even by Filippo’s early biographers.

#### **Doing the Impossible**

The most famous of Filippo’s achievements in raising the Cupola over this enormous space was that he did it without the traditional *centering*, a pre-formed board structure reinforced by a wooden framework. This framework supported the masonry and remained in place until the mortar had set and mostly shrunk, and was then carefully removed. The amount of wood that would have been required to build such a centering not only far exceeded the Florentine exchequer, but may have required trees larger than those that grew in the forests of Tuscany!

The diameter of the Florentine Cupola was much larger than that of Hagia Sophia in Constantinople, a sixth-century building celebrated as one of the wonders of the world (approximately 27 meters); and was equal to the dome of the Pantheon in Rome of the early second century. The Greco-Roman building technology that had achieved those

two earlier, hemispheric domes was long since lost. Moreover, Brunelleschi was faced with an esthetic requirement far more demanding than the Greco-Roman models, because the dome of Florence was to be imposing both on the outside and on the inside, just as the individual interacting with a free, republican society mirrors the internal beauty of his soul in the external beauty he creates in that society. The ancient domes, products of the first and second Roman Empires, had been designed to be magnificent within, but externally they lacked the concept of perspective by which the Brunelleschi dome, lifted on a high drum well over the shoulders of the cathedral nave vaults, dominates the entire city and surrounding hills as far as the eye can see.

The Cupola was the fitting manifestation of a culture that was fighting for the doctrine of the immortality of the *individual* soul and struggling to frame a constitution that would wed individual liberty to the highest common good.

In 1446, after Brunelleschi had died, the Consuls of the Wool Guild, the republic's strongest economic body, hinted at their recognition that the architect had begun a revolution in political economy in their decision to accord him the exceptional honor of burial in the Cathedral. They singled out for praise Brunelleschi's success in cheapening the cost of the enormous project such "that by his careful economy the greatest expenses that it would have been fitting for his genius and intelligence to make were removed. . . ."

Brunelleschi himself conceived of his achievement on a much higher level, however. In a famous exchange of sonnets, he replied to an invidious attack on the project (ca. 1425), by asserting: "When hope is given us by Heaven, . . . we rise above corruptible matter/ and gain the strength of clearest sight. . . . Only the artist, not the fool/ discovers that which nature hides./" In the final tercet of his sonnet, Filippo confidently concluded that his enemy's "sour notes" would be exposed, "when your 'impossible' comes to pass" (Hyman 1974).

### The Dome He Inherited

Brunelleschi, born in Florence in 1377, grew up under the shadow of the unsolved technical problem of covering the east end of the cathedral, or Duomo. The previous generation of Florentine leading citizens, including his own father, a well-known notary, had decided upon a project that was esthetically bold but structurally weak, when in 1367, they mandated the dimensions of the Cupola's octagonal base with an internal diameter that comes out to about 42 meters when one converts the Florentine *braccia*, a unit about the length of a man's arm (*braccio* in Italian), into modern terms.

The dome was the crowning touch (but for the aborted project of the cathedral facade) in the centuries-long project of building the Cathedral Square in Florence, the group of buildings that included the beloved octagonal Baptistery from the 11th century, the Bishop's Palace, the cathedral (originally named Santa Reparata), Giotto's Belltower (Campanile), and the carefully designed surrounding square with the adjoining buildings mandated by law to follow certain design guidelines.

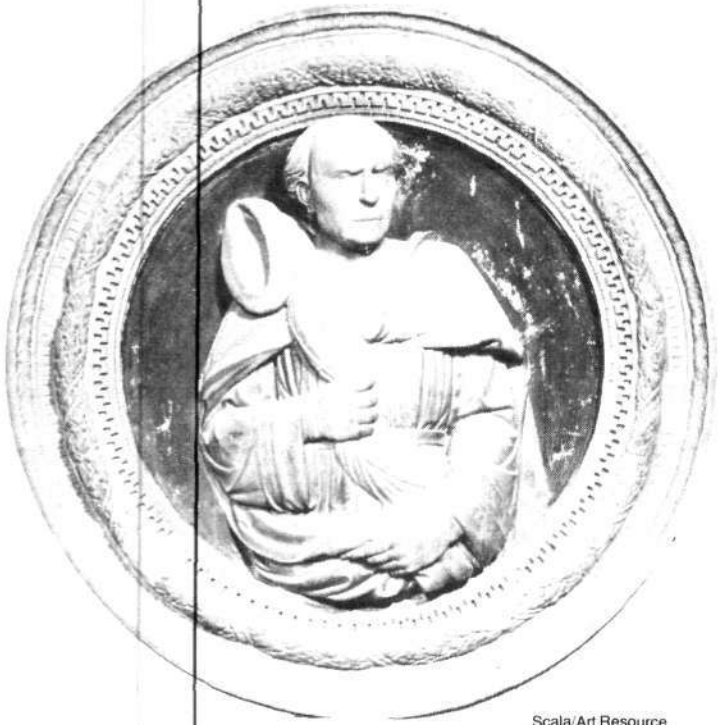

Scala/Art Resource

Brunelleschi, as portrayed in a sculpture inside the Florence Cathedral by Buggiano, ca. 1447.

With the emergence of the free Communes in the 12th and 13th century, the late-blooming towns of central-north Italy developed a bipolar city plan, as the bishops were supplanted as the primary political authority by secular communal governments with their own palaces. In the case of Florence, this urban development reached a high point in the 1290s, around the time that Florence's greatest son, the poet Dante Alighieri, was entering the political career that led to his persecution and exile. During that decade both the new Priors' Palace, where the city's highest officials resided during their two-month term in office, and the new cathedral, rechristened Santa Maria del Fiore, were begun.

The cathedral was always the seat of the bishop; and while the bishop had lost his temporal power, the cathedral complex remained the center of expression of Florentine civic identity, irrespective of party politics.

Commissioned in 1294 from the prominent sculptor and architect Arnolfo di Cambio, Santa Maria del Fiore had a ground plan many times larger than the old Santa Reparata. Whether Arnolfo's building was designed to include a dome, no document proves with certainty; an oral tradition about his project, still alive in the 15th century, suggests that the distinguished Arnolfo indeed planned an enormous church with a vaulted nave and side aisles and a huge cupola (dome), which would not be situated above the structure of the nave as in Pisa's cathedral, but would have its own basement that would stand out from the ground up, built for that purpose. This was what had been done by Florence's leading rival in Tuscany, the city-state of Siena, although the Sienese cathedral would seem almost diminutive next to Florence's Santa Maria del Fiore.

From 1357—less than a decade after the Black Death that had swept away perhaps 50 percent of the Florentine popu-

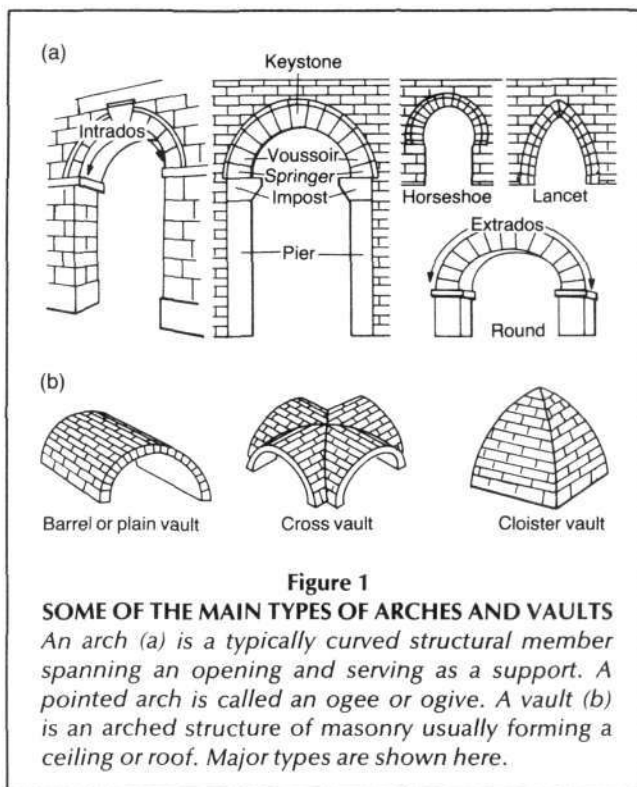

**Figure 1**  
**SOME OF THE MAIN TYPES OF ARCHES AND VAULTS**  
 An arch (a) is a typically curved structural member spanning an opening and serving as a support. A pointed arch is called an ogee or ogive. A vault (b) is an arched structure of masonry usually forming a ceiling or roof. Major types are shown here.

lation—we have the first definite reports of a cupola, about 37 meters across, occurring in the plans for Florence Cathedral. The measurements are taken from a scale model made by one Francesco Talenti, then chief architect, in whose time the decision was also made to build the church “completely of stone.” Talenti’s is one of the first recorded of a whole series of large-scale models that remained on public display within the cathedral as the project proceeded.

The second project is known as that of the “masters and painters” of 1367. They established the present ground-plan dimensions of 42 meters diameter for the cupola, and also, many believe, set the form of a high octagonal tambour or drum with large round windows, which would lift the Cupola above the vaults of the nave and cause it to soar freely over the city against the backdrop of the surrounding hills (Sanpaolesi 1965).

The professional architects of the cathedral in the second half of the 14th century wanted to use the Gothic structural form of flying buttresses—outside supports to bolster the walls so that they could thereby be made taller and penetrated by more windows. But the artists insisted that a more “Italian” form required heavier walls, and they rejected flying buttresses. According to one account: “In October 1367, the city organized a large, new committee to make a final decision in the dispute between Gothic and Romanesque factions. . . . One member was [Filippo’s father] Ser Brunellesco di Lapo Lapi, who had just returned from a trip abroad as a lawyer in the service of Florence. . . . The committee expressed itself in favor of the artists.” The decision was then confirmed by a referendum of some 500 citizens (Prager and Scaglia 1961, p.9).

Work on the dome proceeded apace in the first decade of

the 15th century, under the Gothic-trained master Giovanni d’Ambrogio, who once again tried to introduce buttresses, which he was ordered to lower. The tambour, begun around 1410, raised and strengthened the support of the cupola and also showed an interest in perspective not likely in the 14th century. This is one reason that scholars Prager and Scaglia have strongly argued that this tambour, in the form it exists today, was not decided upon until around 1410—a point at which the 33-year-old Filippo Brunelleschi, well established as a sculptor and beginning to be known in architecture, might well have intervened. Their argument is encouraged by the fact that the main pictorial image of the Florentine Cupola, from after 1367 but before Brunelleschi, shows the dome without a high tambour. It was not until the next stage, the competition of 1418, that there is firm documentation of Filippo’s role.

### Brunelleschi’s Model

On August 19, 1418, the Opera del Duomo (Cathedral Works) announced a public competition. Likely, the terms of the context were suggested by Brunelleschi himself, who knew that he could win. Their announcement reads in part (Prager and Scaglia 1961, p. 27):

Whoever desires to make any model or design for the vaulting of the main Cupola of the Dome under construction by said Opera—for an armature, scaffold or other thing or any lifting device pertaining to the construction and perfection of said Cupola or vault—shall do this before the end of the month of September. . . . If. . . the model . . . be used . . . he shall be entitled to a payment of 200 gold Florins, and if any one does work in connection with this matter the Opera will . . . compensate him. . . .

Of some 20 models submitted, Filippo’s was unique in proposing to omit the wooden structure that supported the masonry of a dome or vault while under construction. He also had novel ideas for the masonry design. He proved these ideas by his model, which the Opera built for him on a scale of approximately 1:12 so they could inspect and test it while in progress. When the model was completed at the end of October, Giovanni d’Ambrogio was fired as chief architect. By July 1420, Brunelleschi’s final plans for the dome were approved, and work began.

The construction, as can be seen from the first detailed analysis, made by G.B. Nelli in the 18th century, relied upon the use of 24 upright ribs (8 major and 16 intermediary) interconnected by several kinds of horizontal supports, which included tie rings or “chains” of stone and wood. The “crown” of the cupola consisted of an inner and outer shell, separated by a space.

### The Construction of Arches and Vaults

Since very ancient times the arch has been the only structure to cover a space longer than the longest beams available (Figure 1). The bricks or stones of the arch are disposed in such a way that their joints are all pointing to the center of curvature. In case of a pointed arch (ogive), the bricks point to the center of symmetry (the middle) rather than to

the two centers of curvature. The construction of any arch requires a scaffolding able to sustain the weight of the bricks, at least until the arch has been completed and the last brick posed. Also, the construction of simple vaults (comparable to a succession of arches with a round, elliptical, or ogival section) requires a framework.

Brunelleschi's younger contemporary and admirer, the architect and theorist Leon Battista Alberti, knew very well, as the ancients knew, that the key to the stability of the arch was in its geometrical closure, and that the issue was quite different for domes with a circular base.

The fact that the Romans built the Pantheon with a very obvious opening just in the place where the keystone of the arch is usually placed, seems to underline that the understanding of the principles behind the stability of spherical domes was quite deep. Alberti, in his *Ten Books on Architecture* in 1452, is very explicit: Spherical domes (the "perfect cupola") can be built without a framework, or with a very light scaffolding (Alberti 1755, p. 59):

Yet there is one sort of vault which stands in no need of these machines, and that is the *perfect cupola*; because it is composed not only of arches, but also, in a manner, of cornices. and who can conceive the innumerable ligatures that there are in these, which all wedge together, and intersect one another both with equal and unequal angles? So that in whatsoever part

of the whole cupola you lay a stone, or a brick, you have been said at the same time to have laid a keystone to an infinite number, both of arches, and cornices. And when these cornices, or arches are thus built one upon the other, if the work were inclined to rinate, where should it begin. . .? You may likewise turn the angular cupolas without a center [framework], if you make a perfect one [cupola] in the middle of the thickness of the work.<sup>1</sup>

Brunelleschi's dome is of the type called angular cupola (sphaericam angularum) by Alberti, consisting of "a number of barrel vaults meeting in a point at the top," the number in this case being eight cylindrical vaults that meet at the corners of the octagon and form the ribs.

### The Shape of the Dome

Filippo left no written documents that can be used to derive definitively his method of construction. There are no drawings from his hand, and the brickwork of the two shells, although visible in part in the space between them, is mainly covered up on the inside by the frescos and on the outside by the red tiles that form the roofing. What little can be seen of it confirms the extraordinary quality of the bricks themselves and the precision with which they were laid, operations that were personally supervised by the architect from start to finish.

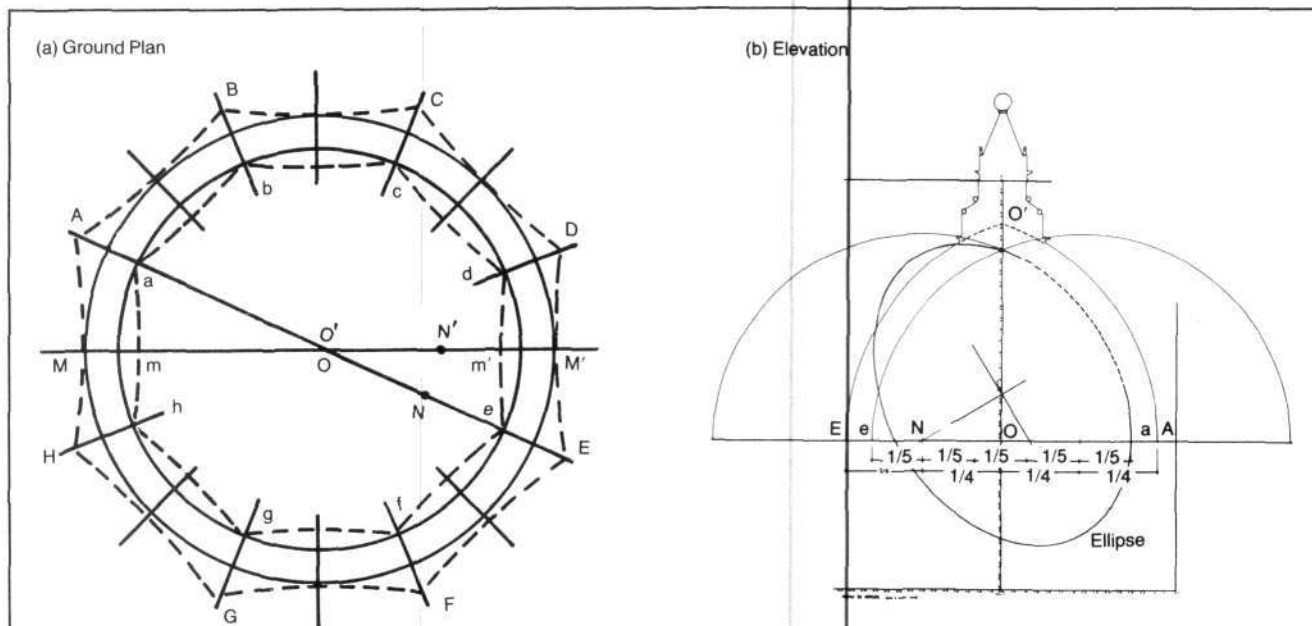

Source: Ground plan by Claudio Rossi, after Lando Bartoli.

Figure 2

### HOW BRUNELLESCHI CONSTRUCTED THE CURVATURES OF THE INNER AND OUTER DOMES

The ground plan of the dome (a) shows the projection of curvature of the vault segments ("cells" or "sails"). According to Bartoli's hypothesis, the center for the differing curvature of the internal ("pointed fifth") and external ("pointed fourth") shells is the same (O), as can be seen in (b), a diagram of an elevation of the dome, based on the Giannini photogrammetric survey in 1967-1968. The arc of the circle constructed from that center and the arc of the ellipse whose center lies on the vertical axis of the dome are virtually identical.

We know from archival documents of the period of the dome's construction that he was asked to build the dome with a curvature of a *quinto acuto*, or pointed fifth; that is, the radius of curvature of the rib of the intrados (the inner shell) had to be  $4/5$  of the diameter of the circle circumscribing the octagon of the intrados at the base. But in the 16th-century biography of Filippo by Vasari, the curvature is repeatedly described as a *quarto acuto*, which means pointed fourth.

Very precise photogrammetric measurements were made of the dome in the 1960s. Because of unavoidable imperfections in construction and the deformations caused by settling over centuries, the data are not uniform, nor are the sides of the octagon perfectly equal. But taking this into account and looking only for a level of precision that was meaningful on the scale of observation of the dome's builders, Bartoli has given a highly convincing hypothesis about the shape of the dome, showing that the inner and outer shells have two different curvatures that correspond to arcs of two circles constructed from a common center (Bartoli 1977).<sup>2</sup> (Others suggest that the curvature of the ribs may actually correspond to a different curve, the tractrix.)

The photogrammatic measurements average out to show that the giant ribs on the extrados (outer shell) of the dome are best described as arcs of an ellipse. But, as Bartoli notes, the maximum difference between this very precise ellipse and an arc of "pointed fourth," which is the kind of curvature used to describe the dome by several architects of the time of Brunelleschi, is only 3 or 4 centimeters, which is absolutely insignificant if compared to the giant ribs of 40 meters in length.

On the basis of these facts, Bartoli concludes that Brunelleschi gave a curvature of a pointed fourth to the external edge of the dome (the arc that is drawn from  $A$  to the top of the dome  $O'$  has as its center the point  $N$  and the radius  $AN$  is  $3/4$  of the diameter  $AE$ ) and of a pointed fifth to the internal edge of the dome (the arc from  $a$  has as its center the same point  $N$  and the distance  $aN$  is  $4/5$  of the internal diameter  $ae$ ). As noted, the circles of the pointed fourth and pointed fifth for the external and the internal surface of the dome have the same center and are therefore the generating curves of the two parallel surfaces of the dome (Figure 2).

In Bartoli's analysis, the ribs are arcs of circles whose radius is  $3/4$  of the diameter of the octagon of the external surface of the dome (pointed fourth). Similarly, the parallel curve of the inner dome (intrados), at the edge between two vaulting cells, would be an arc of circle whose radius is  $4/5$  of the diameter of the octagon of the internal surface of the dome (pointed fifth), and whose center is the same point  $N$ .

On this basis, the vaulting cells have a cylindrical curvature, but the cylinder is not of circular cross section. It is, rather, generated by an ellipse that results from the projection of the circle of the ribs (for example  $AO'$  or  $O'H$ ) on the axis ( $MM'$ ) of the side of the octagon. In other words, to obtain the ellipse of the vaulting cell one must project a circle on a plane that forms an angle of 22.5 degrees ( $1/2$  of 45 degrees, the angle at the center formed by the radii  $AO$  and  $OH$ ).

The pointed-fifth curve happens to be an arc of a circle whose radius is in the ratio of 8:5 to the radius of the circumscribing circle of the internal octagon base—a ratio in the Fibonacci series that closely approximates the famous Golden Section, the self-similar growth ratio. Throughout the 15th century, this 8:5 ratio was used as the equivalent of the Golden Section, which at the end of the century was named the Divine Proportion by Leonardo da Vinci's collaborator Luca Pacioli. Similarly, the pointed-fourth curvature yields a ratio of  $3/2$  of the radius of the external base octagon to the radius of the vault curvature, another proportion in the Fibonacci growth series.

Bartoli provides the following dimensions for the dome (Bartoli 1977):

diameter external octagon ( $AE$ ) = 54.50 meters  
curvature of the rib ( $AN$ ) = 40.90 meters

diameter of internal octagon ( $ae$ ) = 45.50 meters  
curvature of the intrados = 36.40 meters

It is easily calculated that the point  $N$ , from which the two curves are projected, will be the same point. It was precisely because of this device of using two different curves, with a common center, that Brunelleschi's rabid enemy, Giovanni di Gherardo di Prato, attacked him around 1426, in a detailed critique of the construction of the dome, for having allegedly deviated from the original design of the dome, which called for a "pointed-fifth" curvature (Figure 3).

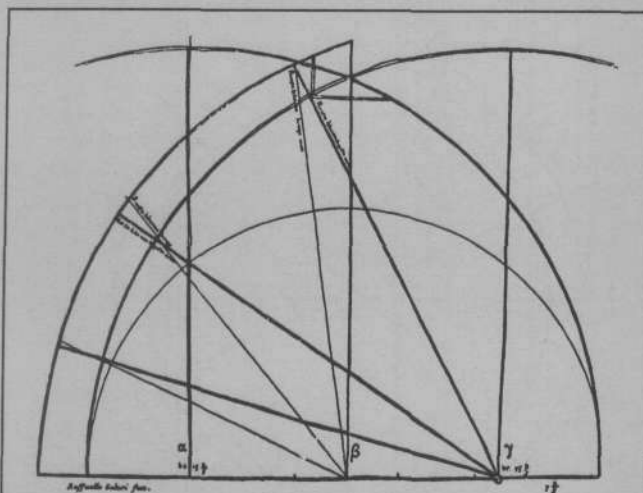

Source: L. Bartoli, *Requiem per una Cupola*, Florence, 1988.

### Figure 3 HOW BRUNELLESCHI BROKE THE 'RULES'

Brunelleschi's critic Giovanni di Gherardo da Prato accompanied his complaints about Brunelleschi with this drawing, ca. 1426, as reproduced by Nardini Despotti Mospignotti. Giovanni complained bitterly that Brunelleschi was breaking the rules and not giving the same "pointed fifth" curvature to the inner and outer shells of the dome, but rather projecting both curves from a common point.

The cylindrical surface that connects the side  $AH$  to the top of the dome  $O'$  is generated by an ellipse that has as its major axis the distance  $AN$  (starting from  $N'$ , of course perpendicular to the surface of the paper), and as a minor axis the distance  $MN'$  (which is a projection of  $AN$  on the plane  $MM'$ ).

### The Model of the Dome

Brunelleschi's contemporaries could not believe that he would have been able to build a dome like that without a framework. He demonstrated the appropriateness of his ideas on the constructive techniques of the dome, not by explaining with words but by building a sort of real-scale model of the method of construction. In the church of San Jacopo sopr'Arno he was commissioned to build a hemispherical dome (*cupoletta*) 4.5 meters in diameter over the Schiatta Ridolfi chapel. According to Brunelleschi's biographer Manetti, it was built "in that way that is still called a *cresta e vele* [by 'crest and sails']" and furthermore ". . . with a cane or stick fixed in the lower part, turning on every side, and while going up it was getting narrower, touching the bricks that were laid, until the dome was closed" (Bartoli 1988, p. 46).

Contemporaries understood. Today this seems more a mystery. The description deals with two features of the construction: on one hand the masonry technique or the building method, and on the other, the shape, which is

hemispheric. Because it is clear that the dome of Santa Maria del Fiore had to be octagonal, not hemispheric, the aspect of the shape of the cupoletta of Schiatta Ridolfi must be understood as a description of the *structural* shape of the dome—but this aspect will be dealt with later on.

A well-known drawing attributed to a Florentine architect from the later 15th century, Antonio da Sangallo the Elder, is associated with the "herringbone" brickwork used for vaulting in Florence without the benefit of centering, as the inscription on the drawing stipulates (Figure 4). This drawing, however, differs from the Cupola of the cathedral in that it describes a hemispheric dome of circular ground plan, as in the Schiatta Ridolfi model.

So, what are the "crests and sails" and the "herringbone"?

It is possible to build a small circular dome by setting the bricks on horizontal courses, with the upper side of the bricks leaning toward the center of the dome. The rings of bricks will be ever more inclined toward the center of the dome, as one layer of bricks is added on top of another. When the slope of the upper side of the wall in construction becomes steep enough, every brick laid tends to slide on the previous layer and it will be necessary to sustain it with a light scaffolding, at least until the ring of the bricks is completed. The completed ring has its own stability and cannot slide any longer, as Alberti explains, so that at that

*Continued on page 34*

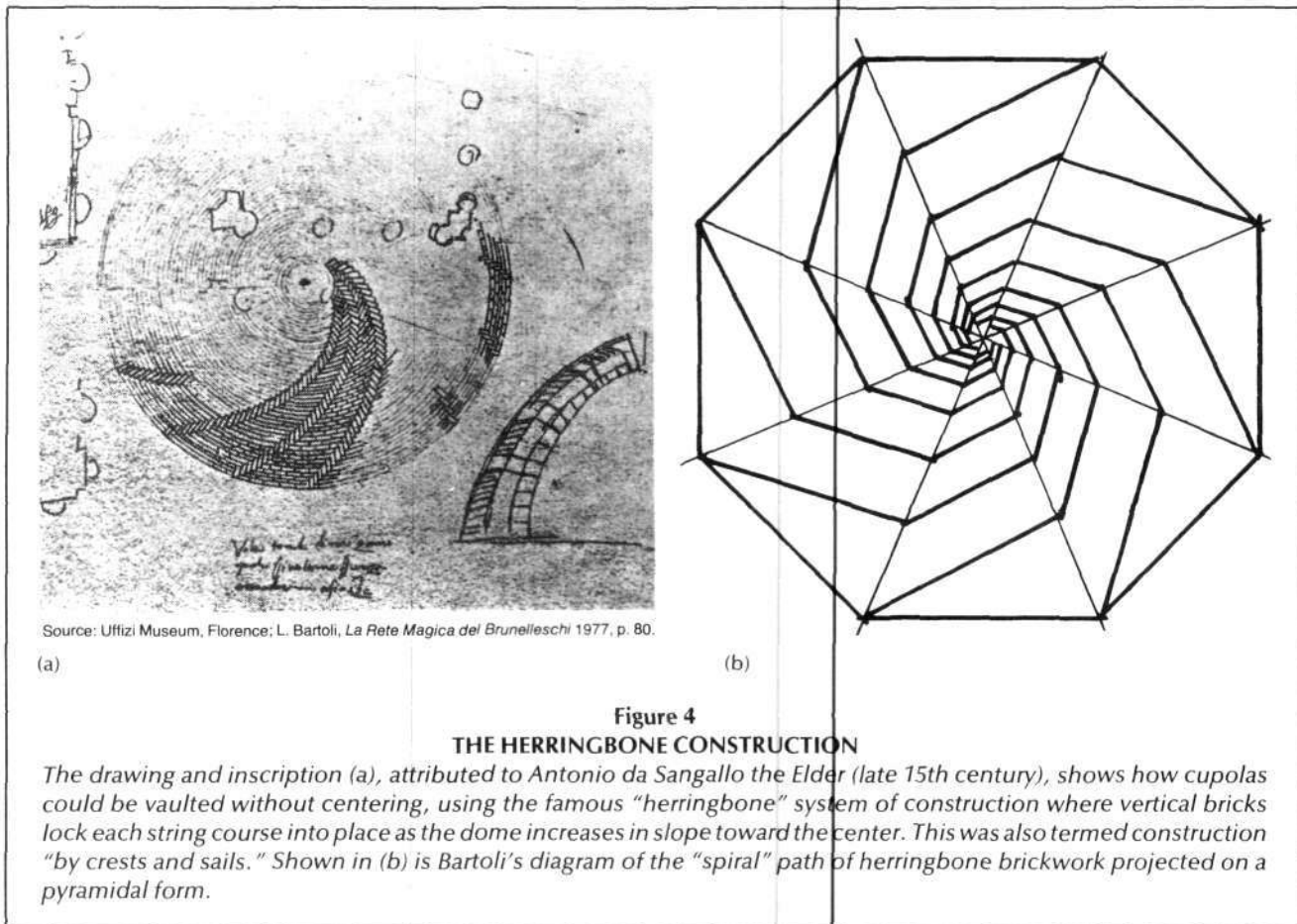

Figure 4

### THE HERRINGBONE CONSTRUCTION

The drawing and inscription (a), attributed to Antonio da Sangallo the Elder (late 15th century), shows how cupolas could be vaulted without centering, using the famous "herringbone" system of construction where vertical bricks lock each string course into place as the dome increases in slope toward the center. This was also termed construction "by crests and sails." Shown in (b) is Bartoli's diagram of the "spiral" path of herringbone brickwork projected on a pyramidal form.

# The 1439 Council of Florence Affirms the Idea of Progress

On July 6, 1439, in the city of Florence on the Arno river in north-central Italy, the assembled Church hierarchy and imperial authority of the Eastern Orthodox Church and the leaders of the Roman Catholic Church jointly proclaimed a document of Union entitled *Laetentur coeli*, "Let the Heavens Rejoice." After the great Schism, dating from the mutual excommunications of the Pope and Patriarch of Constantinople in 1054, the Council of Florence had finally reunified the Eastern and Western branches of Christianity. The Union occurred at a moment of mortal strategic peril to European civilization, when the Ottoman Turk threatened to overrun the entire continent.

The Union was proclaimed jointly by the Greek Bessarion and the Italian Cesarini from the pulpit of the Florentine cathedral of S. Maria del Fiore, under the great Cupola that had just been completed in 1436. As the two major branches of Christianity convened to rediscover their common roots in the period of the Early Christians' struggle against the Roman empire, they witnessed the literal, physical rebirth of civilization before their very eyes, in a building that harkened back to antiquity's achievements but surpassed them.

At the Council, the Byzantines finally agreed to the doctrine that had long distinguished the Western, Augustinian form of the faith: the "Filioque" clause added in the West to the Nicene Creed, which clause was understood to define the necessity of technological progress as a central premise of the doctrine of the Trinity, by stating that



The proclamation of unity is celebrated on July 6, 1439 from the pulpit under Brunelleschi's Cupola, by Cesarini for the Latins and Bessarion for the Greeks. This is a detail of the bronze door of St. Peter's Basilica in Rome, 1444, by the sculptor Filarete.

the Holy Spirit proceeds both from the Father *and the Son* (in Latin, *Filioque*), who is both God and man.

## Scientific and Technological Progress

Because it pivoted upon the concept of scientific and technological progress, the Council of Florence was to lead to a reaction from the Russian hinterland of Orthodoxy, where a violent rejection of the lessons of Florence soon led to the imperial doctrine of "Moscow the Third and Final Rome." It also led directly to the voyages of discovery and the subsequent founding of the American republic as an outgrowth of the Italian Renaissance ideals. This sowed the seeds for the great strategic conflict of the 20th century, already in the 15th century.

At the outset of the 15th century, as the strategic threat of the Turkish conquest grew, Western Europe was a shambles. Neither France nor England really existed—they were torn apart by the Hundred Years' War into feudal entities, and the centralized nation-state was a shriveled shadow of its former self. Recovery from the massive depopulation of the 14th century, which had begun at least 50 years before the outbreak of the Black Death in 1348, was slow throughout the continent. Cynicism over corruption had wrecked the institutional credibility of Church amid the demoralization that followed the Plague. The Schism of the West had led since 1373 to two, and after 1409, three competing popes. The grand historical design of the Conciliar Movement was to bring a new Christian unity into being, based on higher principles.

The first major step was accomplished at the Council of Constance 1414-1418, where a single Pope was elected, Oddo Colonna, as Martin V, and the rivals all renounced their claims. Under Martin V, the process of resolving the Hundred Years' War began to move forward, under a diplomatic effort led by Cardinal Niccolo Albergati of Bologna. Albergati persuaded the powerful Duke of Burgundy to shift his allegiance from England to France, and by 1435, the basis for peace had been established. In Albergati's service were key Florentine-trained figures such as the future Pope Nicholas V, Tommaso Parentucelli, and L.B. Alberti, the first "universal man" of the Italian Renaissance. While in northern Europe, Albergati's portrait was painted by Jan Van Eyck, the greatest Flemish artist of the era, hailed by contemporaries as a profound master of geometry. Further investigation would undoubtedly reveal Albergati as a pivotal figure in the cultural and political birth of the Renaissance.

The conciliarists believed that the reforms of the papacy were still totally inadequate, and convened the



Council of Basel in 1431. It was for this Council that Cusa wrote his first great work, *De Concordantia Catholica*, envisioning a community of sovereign nation-states within a universal church. The lack of unity at Basel ultimately convinced him that the higher principle of concordance he sought would not be found there. He found that higher principle in the strategic task of East-West unity on the basis of the Filioque.

#### Cusa: A 15th Century Benjamin Franklin

Cusa was to the Council of Florence what Benjamin Franklin was to the American Revolution, for which he organized crucial support in Paris. Cusa was the envoy who traveled to Constantinople in late 1437 to fetch the potentates of Byzantium to Italy for an Ecumenical Council, bringing with him also hundreds of Greek patristic manuscripts to bolster the arguments of the Florentines; he then spent a decade—often at the risk of his life—preaching, organizing, and negotiating in northern Europe for the papal cause. Cusa was preventing the break between Germany and Rome, which later erupted with Luther in the early 16th century. One month before the Union was signed, at their ongoing Council of Basel, the German princes' representatives had excommunicated Pope Eugene IV and elected an antipope, Felix V. Cusa's mission was completed only in 1449 when Felix finally renounced his claims; by then, all the German princes and Emperor had recognized the Pope in Rome.

Thus, Cusa was not on hand in Florence to witness the signing of the union proclamation under Brunelleschi's dome on July 6, 1439. The news caught up with him in Germany, whence he wrote jubilantly on Aug. 4, 1439, to his good friend Tommaso Parentucelli, "The Holy Spirit has made itself heard not in Basel, but in Florence." (Parentucelli, a Florentine-trained humanist, became Pope as Nicholas V in 1447, and made Cusa a cardinal of the Church.)

No sooner did the Greek prelates and imperial rulers return to Byzantium in 1443 than the backlash against acceptance of the Filioque broke out throughout the remaining Byzantine territories, whipped up by reactionary monks of the Mount Athos school. The Metropolitan of Moscow, Isidore of Kiev, who led the Muscovite delegation to the Council, had signed the union proclamation and forced the other Russian delegates to also sign. But when he returned to Russia, the other delegates sabotaged the commitment made in Florence and Isidore was expelled from Moscow. The Russian Orthodox Church declared itself autocephalous in 1448, on the basis of explicit rejection of the Filioque, and the doctrine of "Moscow as the Third and Final Rome" was born. Isidore fled to Kiev, where he built up a Western-tied school of thought.

Meanwhile, the Venetian and Genoese oligarchies made sure that no effectual or timely military support was provided to Constantinople as the Turk drew the noose tighter, and in a terrible bloodbath, overran the city in 1453. Only in the last months of the siege did the Emperor finally have the Filioque proclaimed in Hagia Sophia, and

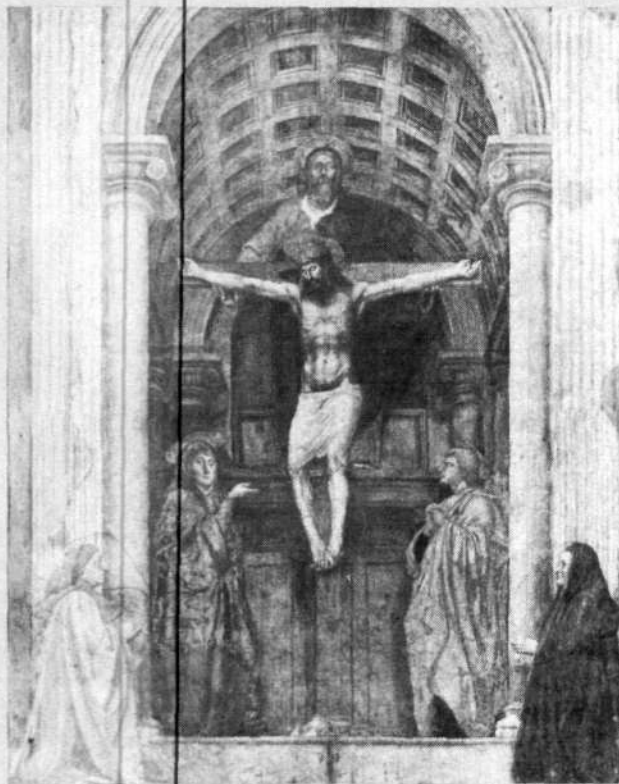

1425 Trinity by Masaccio/Brunelleschi

When the Council delegates convened at the church of S. Maria Novella in Florence in 1439, they were greeted by a life-size fresco by Brunelleschi's painter protégé Masaccio, painted in 1425. A single, heroic Christ is presented simultaneously as a member of the Trinity with God the Father and the dove symbolizing the Holy Spirit (above him), and as Man, in the historical crucifixion scene flanked by Mary and John below.

The necessity of progress is expressed by the magnificent architecture in the new Renaissance style of Brunelleschi, and in the perspective (projective geometry) method of constructing the painting, an invention ascribed to Brunelleschi. The challenge to the living citizens of the Republic to become what Cusa called the "living image of God" (*imago viva Dei*) is imparted by the inclusion of full-size portraits of the donor—a high public official—and his wife, as well as by the direct gaze of the Virgin Mary.

Complementing the Cupola, this painting seems to proclaim, "Vote Filioque!"

by then it was too late. After they conquered Constantinople, the Turks imposed a new Patriarch, Gennadios, on the Greek Orthodox Church, who promptly renounced the Filioque, even though he had been among the signers in Florence.

Constantinople fell, the Muscovites then argued, because it had compromised with the decadent West. This rejection of the Idea of Progress embodied in the Council of Florence is the cultural root of subsequent Russian imperial designs on the West.

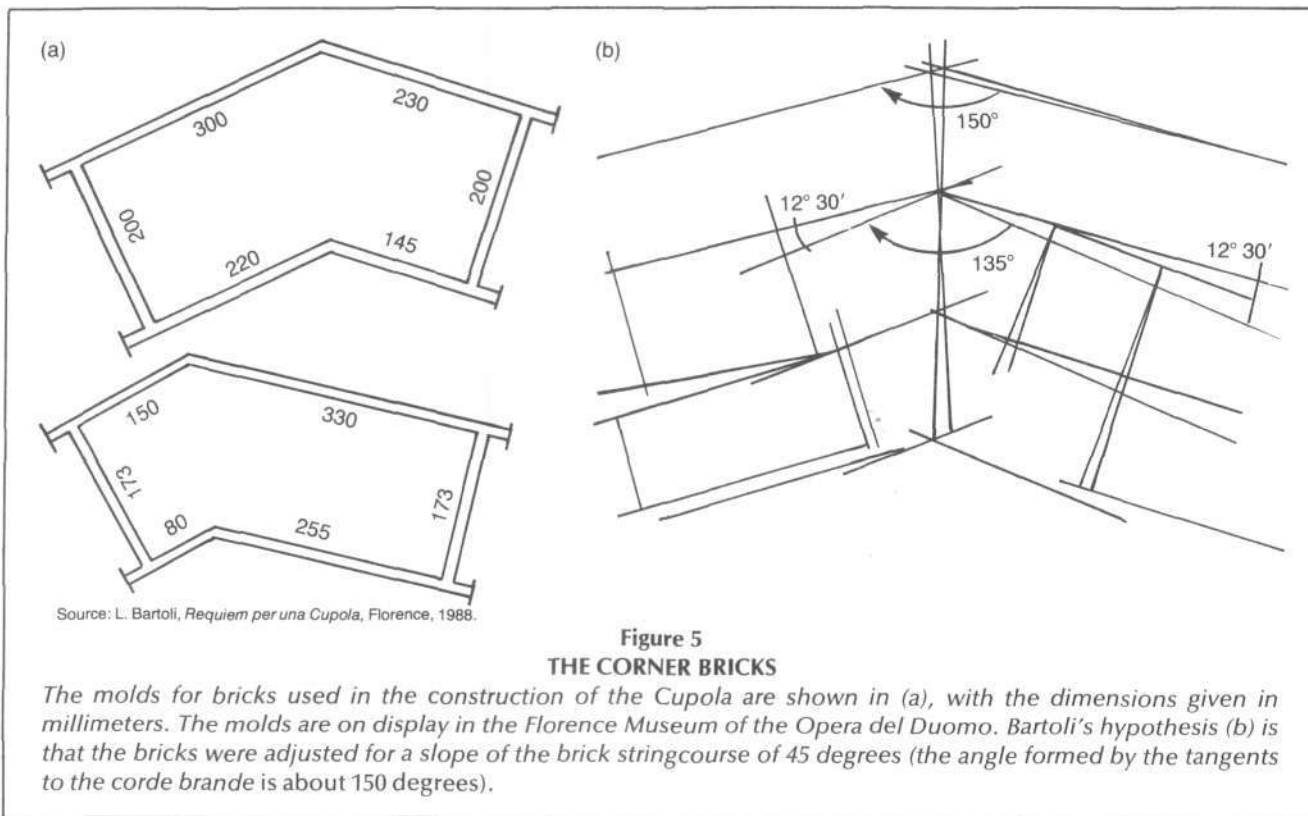

**Figure 5**  
**THE CORNER BRICKS**

The molds for bricks used in the construction of the Cupola are shown in (a), with the dimensions given in millimeters. The molds are on display in the Florence Museum of the Opera del Duomo. Bartoli's hypothesis (b) is that the bricks were adjusted for a slope of the brick stringcourse of 45 degrees (the angle formed by the tangents to the corde brande is about 150 degrees).

Continued from page 31

point the light scaffolding can be moved, to sustain the next layer of bricks.

For a larger construction, but also to make the structure more resistant it is better to link together several rings, as Alberti says (Alberti 1755, pp. 58–59):

But I have observed that some have not always thought themselves obliged to make continued solid ribs, but in their stead have, at certain distances, set bricks sideways, with their head joining into each other, like the teeth of a comb, as a man locks his right hand fingers into his left. . . .

I think, those acted much more prudently, who in raising this sort of cupola [hemispherical] used the same methods as in walling to cramp and fasten the under ring to the next above, and the arches too in several places.

So, after having set some horizontal bricks, one vertical brick is laid. The first course completed, the second is set down, and near each vertical brick of the first course another vertical brick is posed. While the new layers of bricks are being added to the previous layers, the diameter of the ring gets smaller and smaller and the number of horizontal bricks included between two vertical bricks is smaller, until at the top of the cupola it becomes just a herringbone structure, an ordered alternation of vertical and horizontal bricks.

The succession of vertical bricks has the configuration of a spiral with a slope of 45 degrees (these are the "crests,"

compared by Bartoli to the crest of a rooster). The horizontal bricks included between two successive "crests" are the "sails." This method allows one to build hemispherical domes (or at least, domes with a circular base) without a framework. The "sails" are locked between two "crests" which, converging toward the center of curvature, close the bricks of the "sails" as the keystone closes an arch.

#### Noncircular Domes

This does not make obvious, yet, how Brunelleschi proceeded for Santa Maria del Fiore, where the dome is octagonal. In a barrel vault (cylindrical), such as the one that connects any two edges of the octagon, even the structure of the "crests" could not be enough to sustain the "sails," and a centering frame would be absolutely necessary until the dome were finished.

In the dome of Santa Maria del Fiore the bricks are laid by "crests and sails" as if Brunelleschi had built a circular dome. But the dome is indeed octagonal.

In order to build a cylindrical vault, like the eight vaults that constitute both the inner and the outer shells of the dome of S. Maria del Fiore, the bricks would be placed on horizontal courses and the plane corresponding to the depth of the wall of the cupola would be inclined toward the center of symmetry of the dome (in the same way that in the arch, the joints of the bricks all point toward the center of the arch).

The eight planes of the masonry surface of the eight vaults, if connected to the center O of the base octagon, would form an upside-down pyramid. In the edges (in the ground-plan, in the area uniting Hh, Aa, Bb, and so on), the bricks

belonging to two adjacent vaults would have to form an angle (like two adjacent faces of the pyramid) and should be special bricks built in the form of an "open book."

In the Museum of the Opera del Duomo in Florence, there still exist the frames to build irregular hexagonal bricks that form an angle of 135 degrees, exactly the internal angle of the octagon (Figure 5). Such a brick is flat and could be used only in the layers near the base. The fact that it is not shaped like an "open book" prevents its use as the slope increases further up the dome.

This would be the situation *if* Brunelleschi had reasoned as his contemporaries (or as today's engineers and the architects). The corner bricks would have been a mistake. We will see that Brunelleschi did not make a "mistake" and in doing so we will understand the procedure he used.

The courses of the bricks in Santa Maria del Fiore are not set straight on a line parallel to the octagonal base but follow a curved path. Why? Let's go back for one moment to the hemispheric *cupoletta* of Schiatta Ridolfi. In a hemispheric dome, the seams of the horizontal bricks would draw a set of circles reminiscent of the network of parallels on a globe map. The vertical bricks (of the "crests") would be placed along imaginary meridians passing through the north pole (the center of the lantern in the case of the Cupola) and perpendicular to the network of parallels.

As stated above, the courses of the bricks in the octagonal dome are not horizontal but are disposed like a *corda branda* (literally, a hanging rope, hence a catenary) that goes from one rib to the adjacent one.

Now we can begin to learn the lesson of the *cupoletta* of Schiatta Ridolfi. Using a "simple" method of projective geometry, Brunelleschi transformed an octagonally shaped dome into a cupola with *hemispherical* structure.

Let's follow the hypothesis of Professor Bartoli.

First, we draw a circle that circumscribes the octagon at the base. From point *N*, we raise a circle of pointed fourth and draw one rib (for example, the one that goes from *A* to *O'*, the base of the lantern). Now we rotate this rib around the vertical axis *OO'*, which will create a rotational dome that has features similar to the *cupoletta* of Schiatta Ridolfi, except that it is ogival (of pointed curvature) and not hemispherical. The self-sustaining quality is maintained in the ogival dome.

Now, if we draw on the ogival dome a net of meridians and parallels (as on a globe), we obtain a map for the disposition of the bricks in a self-sustaining cupola, like the one of Schiatta Ridolfi.

The ribs of the octagonal (the *real*) dome coincide with eight of the infinitely many meridians of the ogival dome. We must now project the network of parallels (which will become the shape of the "horizontal" courses of bricks) of the ogival dome on the octagonal dome, using the center of the octagon *O* as center of projection. This amounts to using each parallel on the ogival dome as the circular base of an upside-down cone with the apex on the center of the octagon of the base (Figure 6).

The intersection of this cone with the real octagonal dome will give the profile of the courses of the bricks. This layer, which was horizontal in the hemispheric *cupoletta* of Schiatta Ridolfi, will no longer be horizontal in the octago-

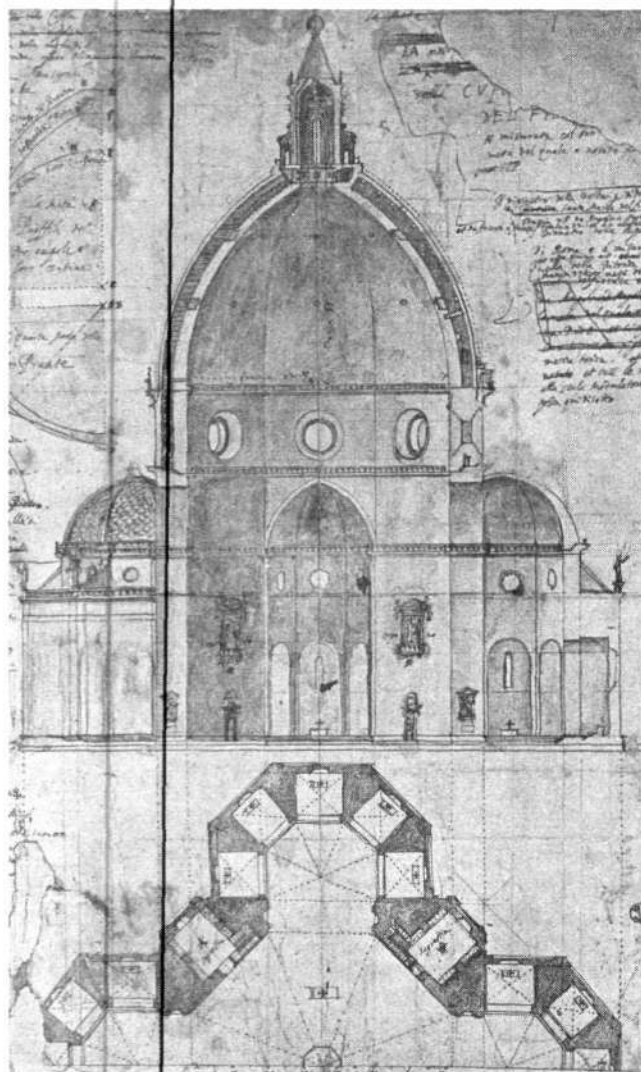

This 18th century drawing shows the Cupola in cross section (above) rising above the octagonal ground plan; half the ground plan is shown separately below. An interesting comparison is made on the upper left between quarters of the ground plans and dome cross sections respectively of the Pantheon, St. Peter's (built in the 16th century on a circular ground plan but with a pointed curvature), and Florence Cathedral. Note the similarity in dimensions.

nal dome, but will have varying height. The maximum height will be on the ribs, while the minimum will be in the midpoint of the octagon: It will be like a *corda branda* (catenary) going from one rib to the other. The surface of the layer of the bricks will correspond to the surface of the interior of a cone and therefore will be a surface without discontinuities, even vis-à-vis the ribs—that is, no shift in direction of curvature at ribs (Figure 7). It should now be clear that it is no longer necessary to postulate strange bricks built like an "open book." The irregular hexagonal bricks conserved at the Museum of Santa Maria del Fiore could have been used very well, and the laying of these bricks would not have been more difficult than covering a flat surface.

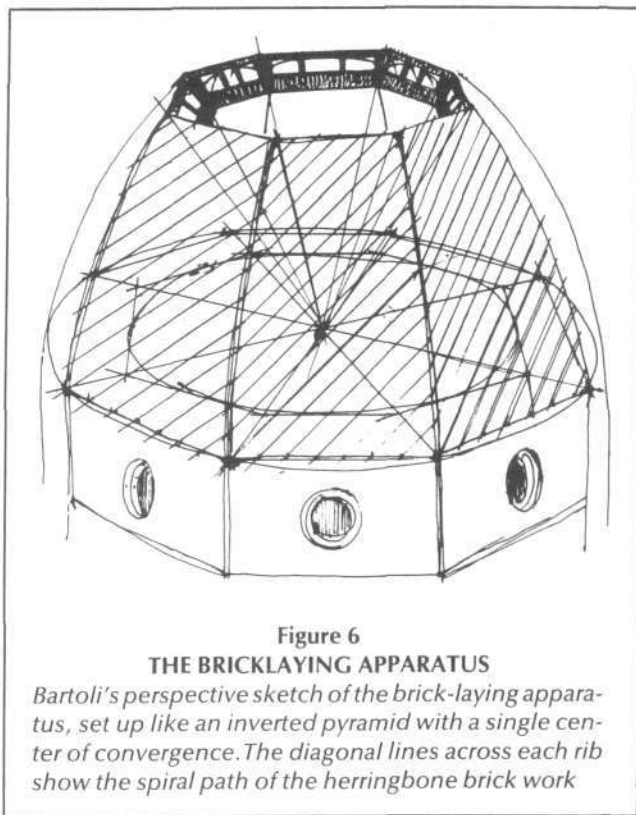

**Figure 6**  
**THE BRICKLAYING APPARATUS**

*Bartoli's perspective sketch of the brick-laying apparatus, set up like an inverted pyramid with a single center of convergence. The diagonal lines across each rib show the spiral path of the herringbone brick work*

Of course, on every horizontal layer we would continue to see the structure of the "crests and sails"; therefore, once in a while one vertical brick belonging to the 45-degree spirals would have to be placed.

The projection of the meridians (the vertical lines of the ogival dome) on the octagonal dome would not be difficult. The meridians are drawn as vertical cross sections of the ogival dome and therefore, in a sense, represent the direction of the field of gravity. They can be drawn (and give the direction in which to lay the vertical bricks) by using an isosceles plumb rule (*archipenzolo*) of the type that was "standard equipment" in the 15th century. The direction of the spiral of the crest could be found by combining the plumb line of the *archipenzolo* and a bevel (*calandrino*) set at 45 degrees (Figure 8).

#### The Florentine Conspiracy

Where did Brunelleschi derive the extraordinary leap in conception that allowed him to solve the problem of vaulting the great dome of Florence without a centering framework, by embedding in its construction the form of a sphere and following the "least action" principle later developed by Leibniz and by the masters of the 19th century mathematical physics, from Gauss to Beltrami?

The answer to that question may never be known in detail, but in broad outline it lies in a political-scientific conspiracy of the late 14th and early 15th century, whose headquarters was Florence. While many partial histories of this period exist, no one has as yet made the obvious connections between the political, artistic, diplomatic, scientific, theological, and *military* aspects of the conspiracy, nor has

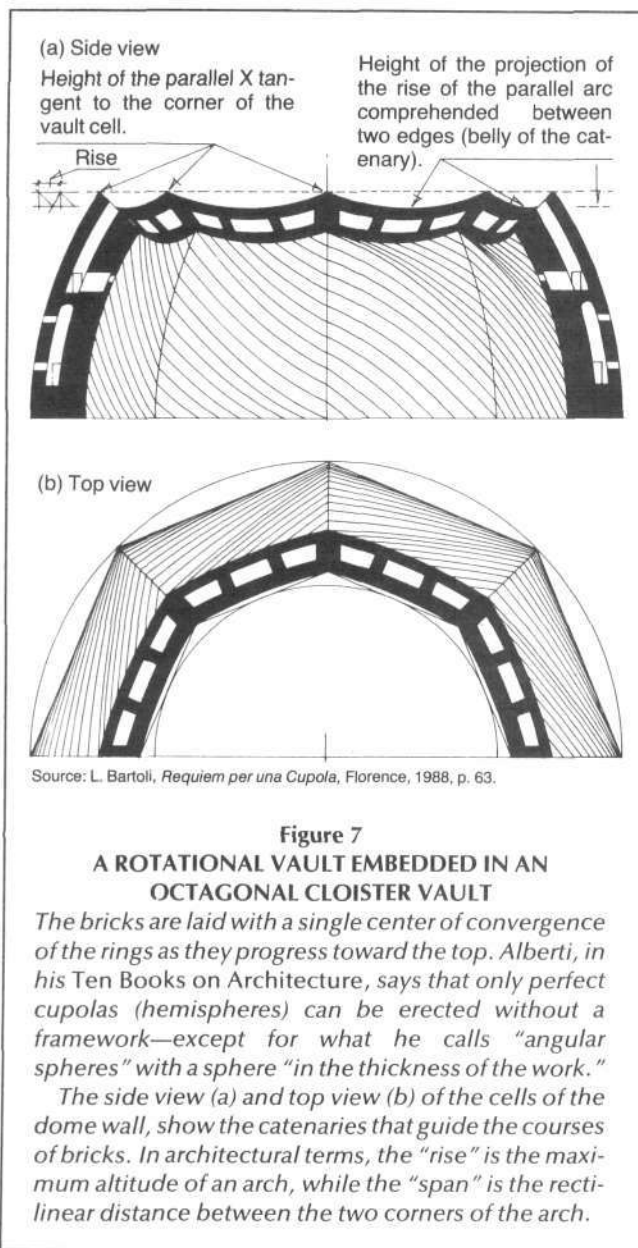

(a) Side view  
Height of the parallel X tangent to the corner of the vault cell.  
Height of the projection of the rise of the parallel arc comprehended between two edges (belly of the catenary).  
Rise

(b) Top view

Source: L. Bartoli, *Requiem per una Cupola*, Florence, 1988, p. 63.

**Figure 7**  
**A ROTATIONAL VAULT EMBEDDED IN AN OCTAGONAL CLOISTER VAULT**

*The bricks are laid with a single center of convergence of the rings as they progress toward the top. Alberti, in his Ten Books on Architecture, says that only perfect cupolas (hemispheres) can be erected without a framework—except for what he calls "angular spheres" with a sphere "in the thickness of the work."*  
*The side view (a) and top view (b) of the cells of the dome wall, show the catenaries that guide the courses of bricks. In architectural terms, the "rise" is the maximum altitude of an arch, while the "span" is the rectangular distance between the two corners of the arch.*

any historian come to grips with the *international* scope of the republican grand design that inspired the Florentine Renaissance. Yet these connections are threads of a network, which becomes clear in outline merely by looking at the personnel involved.

The crucial example is Nicholas of Cusa, the towering leader of advances in physical science of the 15th century. Cusa's writing, dedicated to Paolo Toscanelli, developed the crucial isoperimetric theorem in the process of tackling the Archimedean problem of "squaring the circle." Cusa showed in that book that a circle is the minimum perimeter that can enclose a given area. Kepler and Leibniz later stood on the shoulders of Cusa as they developed the conception of the "least action" principle in the physical universe.

Born in 1401 in Germany, Cusa studied at the famed University of Padua in northern Italy in the early 1420s, together

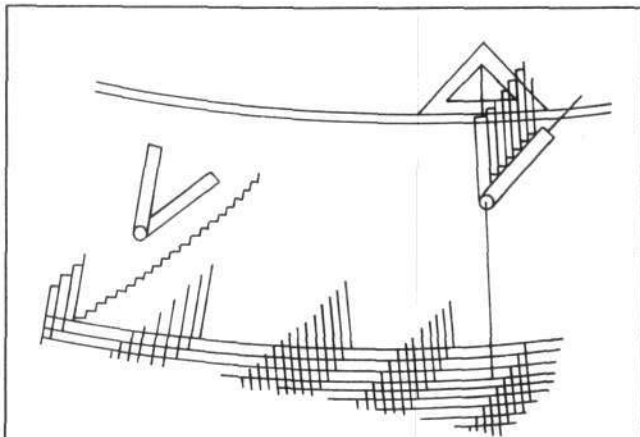

Source: L. Bartoli, *Requiem per una Cupola*, Florence, 1988, p. 66.

Figure 8

#### METHOD OF PROJECTION OF A CATENARY

Bartoli's hypothesis on the use of the "gualandrino with three cords," which was cited in the records of the dome construction as the method of determining the curvature. The isosceles plumb-rule resting with its base on the corda branda (loose rope) and with the altitude of the triangle aligned with the "meridian" would guide one arm of the bevel (calandrino) while the other, set at a 45-degree angle, guided the alignment of the "herringbone" bricks.

with Giuliano Cesarini, who later presided over the Council of Florence, and the Florentine physician and astronomer, Paolo dal Pozzo Toscanelli. Their mutual teacher of mathematical perspective, and probably of music theory, was the famous Prosdocimo de' Beldemandi.

Toscanelli's real importance is hard to judge because most of his own works are lost, but there can be no doubt of his role as a link among the greatest scientific minds of the day. He is reported by early sources to have instructed Brunelleschi in formal mathematics. When Leon Battista Alberti, who was a younger student in Padua at a famous private school during the early 1420s, wrote his treatise *On Painting* in 1435, which launched the theory of scientific perspective, he dedicated it to Brunelleschi, whom he credited as perspective's inventor. Shortly afterward, Alberti dedicated his book *Intercoenales*, a series of remarkable dialogues touching on political economy and other issues, to Toscanelli. Some decades later, Toscanelli designed a gnomon, or sundial, which was installed in the lantern of Brunelleschi's dome and marks the summer solstice at a fixed point on the floor.

All of these circumstances tie Brunelleschi closely to both Alberti and Toscanelli, but do not confirm the connection to Cusa, who was occupied with German affairs throughout the late 1420s and who played a leading role, beginning in 1432, in the Church Council of Basel, for which he wrote his first major book *De Concordantia Catholica*. Cusa traveled to Rome in 1425, and on that occasion he could well have visited Florence, where the dome project was in its early phases of construction and the violent attacks on Bru-



Ambrogio Traversari, the man looking directly out in this detail from the bronze doors of the Florentine Baptistery (known as the "Gates of Paradise"), is one of the major personalities linking the scientific, strategic, and religious threads of the "grand design" of the Renaissance—Brunelleschi and his Florentine contemporaries—to Nicholas of Cusa.

nelleschi by Giovanni di Gherardo di Prato were breaking out. Cusa was well known and respected by the Florentine humanist circle of Traversari and Cosimo de' Medici, who in 1429 sought to obtain from him precious manuscripts of Roman comedies, which the brilliant young German canon had unearthed in a Swiss monastery.

Later, after Brunelleschi's death in 1446, there is absolutely no doubt of the intellectual and personal ties between Cusa and the Florentine group. In 1464, when Cusa died, he made his close friend Toscanelli the executor of his will.

Cusa was probably recruited to the Council of Florence plot by Ambrogio Traversari, a figure who brings together the scientific and strategic sides of the story. It was Traversari, then the general of the Camaldulensian Order, who was sent by Pope Eugene IV in 1435 to the Council at Basel to organize leaders to work for the pope for an Ecumenical Council of East and West, to be held in Italy (Stinger 1977). In 1437, Cusa did indeed leave Basel with a minority group and went on a diplomatic mission to Constantinople (Krämer 1971; Meuthen 1971). Later that year they returned and debarked at Venice with the Byzantine Emperor and Patriarch and their retinues and proceeded to Ferrara, where the Council opened in April 1438. Traversari, later referred to by Cusa as "my good friend," met him again in Ferrara.

Traversari had inherited from the circles of the poet Petrarch the task of leading a group of Florentine thinkers who, since the early 1400s, had been preparing the intellectual ammunition to win the battle for the Western notion of the Trinity over their Greek counterparts. At the prompting of Petrarch, these circles also yearned to liberate Latin learning in the West from the heavy weight of Aristotelian reductionist thinking, and they looked to Greek science, especially as represented by Plato and his school, as the source for a revival of true scientific hypothesis. Under Traversari's encouragement, among others, classical Greek was mastered and the early Greek Church Fathers' writings were scrutinized to develop the arguments that would



Nora Hamerman

Dr. Lando Bartoli (right) with author Claudio Rossi at a May 1989 Conference on the Council of Florence in Rome.

prove there was no contradiction between East and West in the early centuries when Christendom had still been unified. The Byzantines who traveled to Italy for the Ecumenical Council in 1438 were astounded by this Western mastery of their own heritage, including the classical Greek texts that were available in the West.

Traversari was an ardent collector of such texts and a proponent of the thesis that Christianity must not ignore the fruits of classical Greek civilization, but "baptize" these cultural riches to the greater good of Christendom. In 1423, one of his Greek associates brought back to Italy from Constantinople a treasure trove of Plato, some 238 manuscripts. In 1424, Traversari is reported engaged in an assiduous search for a work by Archimedes on military machines and hydraulics, a search that is particularly interesting in regard to the genesis of the isoperimetric theorem by Cusa at a later date.

During the 1420s, Traversari's monastic cell at Santa Maria degli Angeli near Florence was the meeting place for a grouping of humanists linked to the Medici banking family. The following account is based on an essay by Thomas Goldstein (Goldstein 1965). Traversari was personally instrumental in 1433 in saving the life of Cosimo de' Medici when Cosimo was imprisoned by the oligarchic Albizzi family, and he helped to bring the Medici to power in Florence in 1434. Later, perhaps in gratitude for this, Cosimo de' Medici financed the huge costs of bringing the Ecumenical Council, which had initially convened in Ferrara in 1438, down to Florence to escape the plague. Other members of Traversari's entourage included Niccolò Niccoli, whose fabulous collection of antique books formed the basis of the Platonic Academy of Florence; Gianozzo Manetti, author of the first "Oration on the Dignity of Man"; Enea Piccolomini, the future Pope Pius II; and, of course, Toscanelli.

It seems, according to the 19th century historian Uzielli, that there was a long series of symposia on various topics including especially geography, a topic of great interest to the Florentine merchants who wished to break the Venetian grip in the Oriental trade.

Poggio Bracciolini, another humanist in this group, gives us a glimpse of himself, Cosimo, and Niccoli poring over a manuscript of Ptolemy's *Geography*, which had been translated into Latin in 1410 in Florence. Despite its serious flaws, the Ptolemy manuscript employed a spherical projection method of mapping and inspired cartographic reforms. In mid-1428, Prince Pedro of Portugal, brother of the famous Henry the Navigator, arrived in Florence to collect maps and pointers for his brother's enterprise. Florence was the theoretical storehouse for expeditions into Africa from the Iberian peninsula.

It is not difficult to see how the mathematical and geographical studies of this group, occupied precisely with the least-action path of navigation on the globe, would be relevant to Brunelleschi's work on the dome.

Such symposia came to a high point at the Council. In 1439, Gemistos Plethon arrived as part of the Greek entourage brought to Italy by Cusa and gave the Florentines a lecture series on Strabo, the Hellenistic geographer. The Council provided Toscanelli (and Brunelleschi?) with the opportunity to talk with foreign delegates from every corner of the globe and fill in details missing from their mental map. Toscanelli took copious notes. Isidore, the Metropolitan of Moscow, who briefed him about the geography of Russia, was destined to play a key role in the losing battle to bring the Renaissance to Moscow. In 1474, the very elderly Toscanelli reportedly wrote a letter to Christopher Columbus that revised the basic concept of the Earth with the revolutionary premise that the ocean could be used as an intercontinental waterway, and that the navigable Ocean Sea included the Southern Hemisphere.

Toscanelli tells Columbus that he had written on the same subject to Fernão Martins, the canon of Lisbon Cathedral. Toscanelli and Martins may have discussed this question at length at the house of Cusa at S. Pietro in Vincoli in Rome, where the three men met frequently in Cusa's last years (Goldstein 1965).

### The Strategic Dimension

As a "national mission" for Florence, the city with a great civilizing mission, Brunelleschi's dome can be compared best to the prospective United States project to place a colony on Mars by the year 2027. It is also comparable to the crash effort of the U.S. "Manhattan Project" that created the atomic bomb or the original proposal for the Strategic Defense Initiative. Some may object because of the "military" nature of the latter two projects compared to the religious-civilian nature of the dome. However, there was also a pressing military-strategic issue in the Brunelleschi-Toscanelli-Cusa circle. The fact that we know relatively little about this is simply a reflection of the secrecy that was involved—a secrecy to which Brunelleschi himself referred, in his famous "interview" at the end of his life with the Sienese engineer Taccola (Hyman 1974).

At the time of the Council, the Byzantine Empire, the center of Eastern Christendom, had been reduced to a tiny enclave around Constantinople by the military might of the barbaric Turkish hordes. Everyone knew that if the Latin West failed to intervene, the Turks would soon be overrunning continental Europe, spreading in their wake the massa-



Nicholas of Cusa, a leading Renaissance conspirator, in a detail from an anonymous painting in the Cusa Library in Bernkastel-Kues, West Germany.

cre of many Christians, enslavement of the survivors, and destruction of civilization. It is unlikely that the Council fathers could have succeeded in their Florentine conspiracy had this threat not been so clear.

If a successful military campaign had been carried out coming out of the Council of Florence, the cultural superiority of Brunelleschian science and republican political forms of government would have been universally vindicated, just as the Cupola demonstrated to all but the most close-minded Mt. Athos monk present at the Council that Florence had absorbed, and improved upon, the greatest achievements of ancient Greek science. The industrial revolution would have arrived much earlier in the West, and there would never have been a Russian imperial problem of the sort we know today.

Instead, the new crusade was consistently sabotaged, particularly by the Venetians, who, like today's Western advocates of a new Yalta-type condominium with the Soviets, envisioned continuing fat profits from their trade with the East, under the victorious Turk. Later, in 1458, Pius II brought Cusa to Rome and put him in charge of the Church's governance, so that he could travel to the East at the head of such a crusade. However, both men died, without bringing this plan to fruition, in 1464—the same year Cosimo de' Medici died.

Finally in 1571, the major Western military powers united to deliver a crushing defeat to the Turk at the Battle of

Lepanto, which the Spanish genius Cervantes described as the most glorious moment in all of history. This did save Europe from descent into a full-scale dark age, but was too late and too short-lived to prevent the emergence of a new "Turk," the Russian empire.

Yet, for decades, even after Brunelleschi died in 1446, the dome project made Florence's art studios into the "national laboratories" for public works, science, and the military defense of the Florentine republic. In 1431, Filippo won a new competition for the design of the lantern that surmounts the dome, whose form had been partly determined by the architect's decision to make the oculus octagonal rather than round. The lantern was not completed during his lifetime. Leonardo da Vinci, born in 1452, was a young assistant in the studio of the sculptor Verrocchio and helped with the cast of the great ball globe of gilded copper that surmounts the lantern, one of the largest casting projects ever undertaken in Florence. Half a century later, Leonardo reflects in his notebooks on his memory of that youthful experience, as he opened another scientific frontier with a rudimentary design for a telescope.

Nora Street Hamerman, the editor of Executive Intelligence Review, was an art historian specializing in late 16th century Italian painting and architecture until Lyndon LaRouche inspired her to study the Golden Age of the Italian Renaissance. She is writing a book on topics related to this article. Claudio Rossi, who was trained as a draftsman, is the managing editor of Fusione magazine in Italy.

#### References

- Leon Battista Alberti, 1755. *Ten Books on Architecture*, 1755 (English edition, reprinted by Dover Publications, 1986).
- Lando Bartoli, 1977. *La Rete Magica di Filippo Brunelleschi: le Seste, il Braccio, le Misure* (Florence: Nardini).
- , 1988. *Requiem per una Cupola, di Lando del Taccola Legnaiuolo* (Florence).
- Thomas Goldstein, 1965. "Geography in Fifteenth Century Florence," in *Merchants and Scholars: Essays in the History of Exploration and Trade*, edited by J. Parker (Minneapolis).
- Isabelle Hyman, ed., 1974. *Brunelleschi in Perspective*. (Englewood Cliffs, N.J.: Prentice-Hall).
- Werner Krämer, 1971. "Der Beitrag Nikolaus von Kues zum Unionskonzil mit der Ostkirche," in *Nikolaus von Kues als Promotor der Ökumene, Mitteilungen und Forschungsbeiträge der Cusanus-Gesellschaft 9* (Mainz).
- Leonardo da Vinci, 1970. *The Notebooks of Leonardo da Vinci*, Compiled and edited from the original manuscripts by Jean Paul Richter, 2 Vols. (New York: Dover, facsimile of London edition of 1883).
- Ernst Meuthen, 1971. "Nikolaus von Kues in der Entscheidung zwischen Konzil und Papst," in *Nikolaus von Kues als Promotor der Ökumene, Mitteilungen und Forschungsbeiträge der Cusanus-Gesellschaft 9* (Mainz).
- Frank Prager and Giustina Scaglia, 1961. *Brunelleschi: Studies in His Technology and Inventions* (Cambridge: MIT Press).
- Piero Sanpaulesi, 1965. *La Cupola del Brunelleschi* (Florence: Sadea-Sansoni).
- Charles L. Stinger, 1977. *Humanism and the Church Fathers: Ambrogio Traversari (1386-1439) and Christian Antiquity in the Italian Renaissance* (Albany: State University of New York at Albany Press).

#### Notes

1. Lando Bartoli points out when quoting this, that "through any point belonging to a sphere there pass infinite vertical planes, each of which corresponds to an arc of intersection with the sphere."
2. The monograph by Howard Saalman, *Filippo Brunelleschi: The Cupola of Santa Maria del Fiore*, (London: A. Zwemmer, 1981, 317 pp. plus 167 plates) which provides the most detailed available review of all the documentation surrounding the dome, came to our attention too late to be used for this article, but should certainly be consulted by anyone who wishes to study this topic in depth. Saalman is also the editor of a modern critical edition of the early biography of Brunelleschi by Manetti.

# Brunelleschi and the Quantization of Space

by Lyndon H. LaRouche, Jr.

*Brunelleschi's crucial discoveries in the 15th century are relevant today in helping us understand the role of negative curvature in representing the necessity of progress from a lower to a higher phase state.*

## EDITOR'S NOTE

*This essay was prepared as a memorial presentation for a Dec. 20, 1988 meeting in Florence to honor Filippo Brunelleschi and discuss a solution for restoring his Dome.*

**T**he one major work of science on which I hope to complete my essential contributions is the establishment of an adequately intelligible representation of the negative curvature of physical space-time in the regions of singularities within a Riemann surface function of otherwise everywhere positive curvature.

On this account, I wish to emphasize our indebtedness to the relevant work of Filippo Brunelleschi. Although I must confess that I do this, in part, out of love for the memory of that great scientist, my principal motive is a broader and more immediately practical one. These remarks are devoted to a brief explanation of that broader purpose.

My strength in these matters originates in a project of philosophical studies begun at the age of 12, which won me forever to the standpoint of Leibniz's *Monadology*, *Theodicy*, and certain other writings by the age of between 13 and 14. All that I have accomplished in relevant matters, is derived from my undertaking, shortly after that, a defense of Leibniz against the arguments of Kant's *Critiques*. My refutation of the central dogmas of Kant, as summarized in his *Critique of Judgment*, became the notion of intelligibility of the creative mental processes from which is derived everything I deem particularly useful in my attempted contributions to human knowledge.

The overriding importance which I attribute to a Socratic treatment of axiomatics, over mere formal consistency, puts me at a distance from prevailing modern ideas about scientific knowledge and much closer to the spirit of the Golden Renaissance. In such matters, that is a weakness in my work, but also an advantage whenever axiomatic issues of fundamentals respecting ontology are the proper point of emphasis, as is the case in this matter of the axiomatic substrate of notions of curvature of physical space-time. My special viewpoint, so identified, is a valuable contribution to the division of labor on the subject of quantization of physical space-time.

Properly defined, the "quantization" of physical space-time signifies a rejection of the approach to physical science associated with the neo-Euclidean formalisms of Descartes, Newton, and so on. In the view for which I speak, no discrete existence of the sort we tend to associate with naive sense certainty is permitted the quality of self-evident existence. Rather, everything which seems to be a discrete existence is something constructed out of what first appears to our imagination as an undifferentiated continuum of a

*Multiply connected physical least action: The familiar Red Spot in Jupiter's atmosphere.*

NASA



constructive-geometric representation of multiply connected physical least action.

At first, the isoperimetric principle defined by Nicholas of Cusa suggests that the continuum must be defined in terms of multiply connected circular action as the elementary form of physical least action (Figures 1 and 2).

Later, with the work of Gauss, Dirichlet, Riemann, and Weierstrass, we have the higher geometry of the Gauss-Riemann complex domain. This latter domain, in which the characteristic form of functions is associated predominantly with elliptic and hyperbolic trigonometries, is generated by replacing circular with self-similar spiral forms of multiply connected least action (Figure 3).

From this more advanced standpoint, the construction of the kinds of singularities associated with electromagnetic generation of discrete existence from continuous least action becomes implicitly susceptible of intelligible representation. To an expanding degree, we are enabled to elaborate viable functional representations for processes, when adequate such representations of nonlinear processes are not possible in any other known way. Additionally, as Riemann indicated in his dissertation on representation of an arbitrary function, it is implicit that all really existing physical processes are susceptible of representation from such a standpoint (see box, p. 43).

### The Importance of Negative Curvature

It is in this setting that the importance of negative curvature confronts us. The relevance of my axiomatic approach and the broader practical importance of reexamining Brunelleschi's work will become clearer as we proceed to treat the significance of negative curvature.

The most important class of physical functions are those we may describe usefully as elementarily nonlinear. By that we ought to mean that the characteristic feature of the function is an implicitly enumerable density of singularities within the scope of some arbitrarily small interval of action of a continuing physical process.

This class of functions is much more than merely very important. All living processes, if adequately represented,

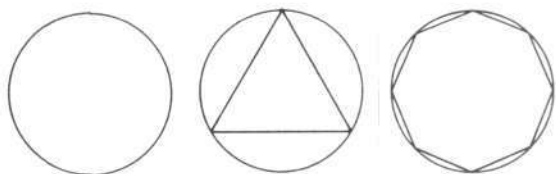

Figure 1  
NICHOLAS OF CUSA'S CIRCLE

Nicholas of Cusa, in his 1440 book *On Learned Ignorance*, showed geometrically that human reason is not attainable through mere logical thought. If we attempt to approach a circle (reason) through construction of polygons with more and more sides (logical thought), it might be thought that we would actually get closer and closer to a circle. Nonsense! A circle has no angles; the more angles we add to the polygon, the further we are from a circle.

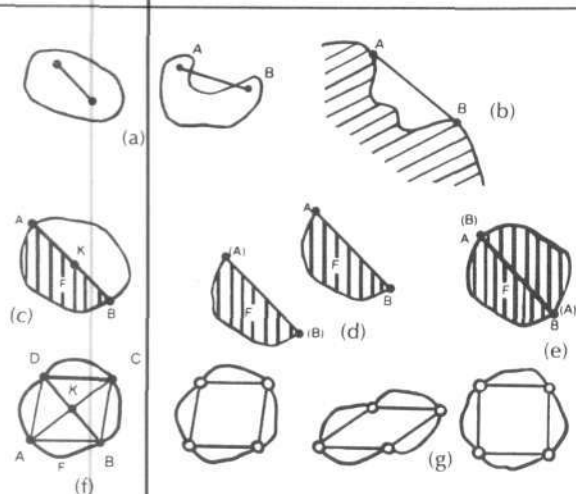

Figure 2

### LEAST ACTION: THE ISOPERIMETRIC PRINCIPLE

About 400 years after Cusa, Jacob Steiner devised the following proof that the circle is the figure that encompasses a maximum area for a given perimeter—also without the use of algebraic axioms. If it is assumed that another figure has been discovered that has this property, then this figure must at least be convex; otherwise, a connecting line could always be drawn from A to B that increases the area of the figure and decreases the perimeter (a).

Take an arbitrary figure (b). The first step—if it is concave—is to transform it into a convex figure by wrapping a string around the figure. This increases the area by the amount shown but decreases the perimeter. Therefore, the last step here is to expand the figure by a continuous amount along its entire edge to bring the perimeter back to its original length.

The second step is to make the figure symmetrical. To do this, divide the perimeter into two parts of equal length, AB and BA (for example by measuring the perimeter with a string and then folding the string in half) (c). Then the figure can be divided along the straight line that joins A and B. Choose the larger of two halves (d). Cut the other half out and rotate the chosen half 180 degrees from A to B (e). Then a symmetrical figure is produced with the perimeter of the original figure and possibly with a greater area. If the new figure is no longer convex, it can be made so by application of the first step.

Next, fold the resulting figure in half twice (f) creating the points A, B, C, and D. Join them with straight lines. They will form either a square or a rhombus parallelogram as shown. If it is a square, we are finished and have transformed the figure into a circle. If it is a rhombus, then the area of the figure can be increased by "straightening" the rhombus into a square, while the perimeter does not change (g).

If this procedure is repeated, then the figure will get closer and closer to a circle. The circle is the only figure whose area cannot be increased in this way.

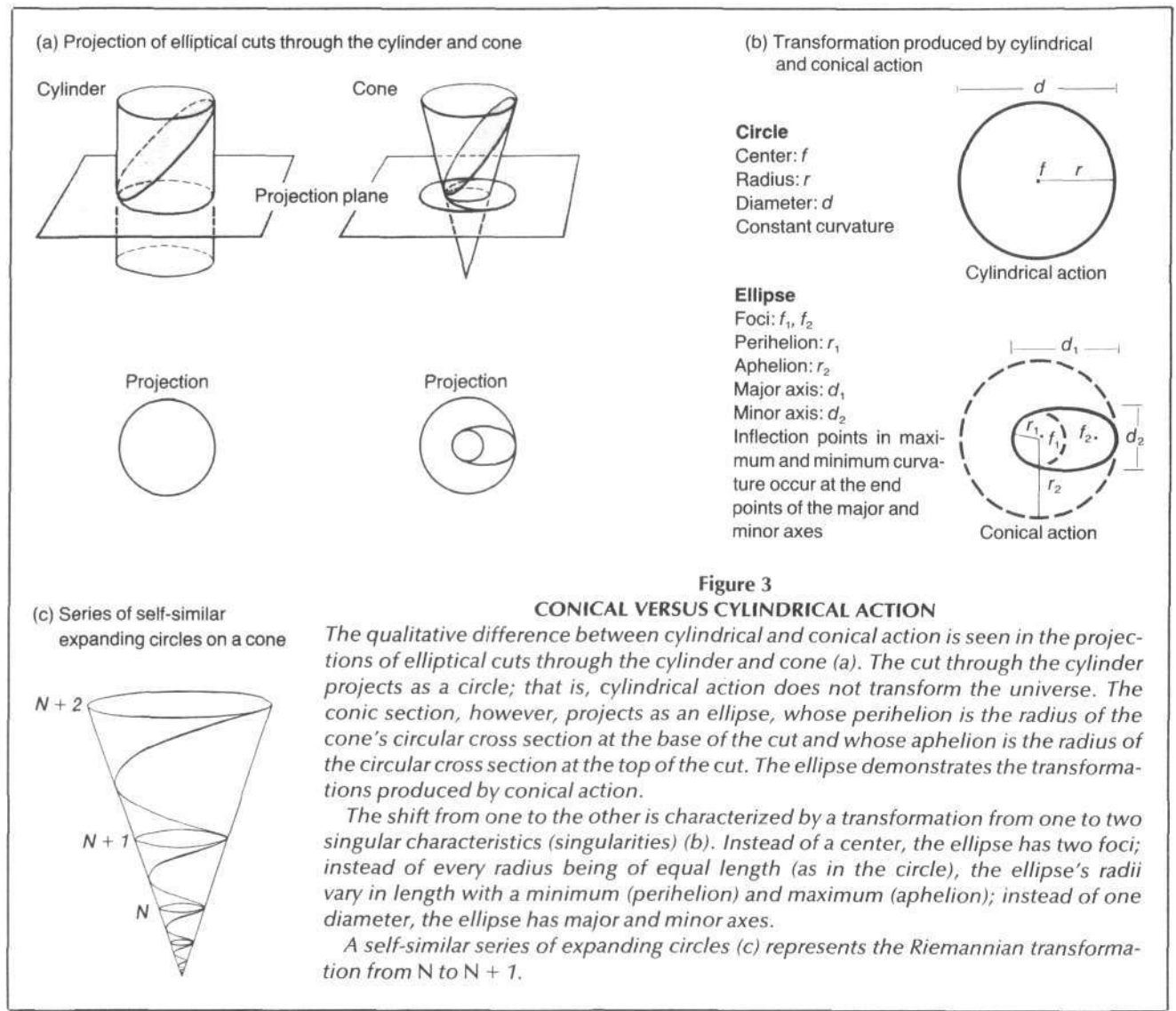

**Figure 3**  
**CONICAL VERSUS CYLINDRICAL ACTION**

The qualitative difference between cylindrical and conical action is seen in the projections of elliptical cuts through the cylinder and cone (a). The cut through the cylinder projects as a circle; that is, cylindrical action does not transform the universe. The conic section, however, projects as an ellipse, whose perihelion is the radius of the cone's circular cross section at the base of the cut and whose aphelion is the radius of the circular cross section at the top of the cut. The ellipse demonstrates the transformations produced by conical action.

The shift from one to the other is characterized by a transformation from one to two singular characteristics (singularities) (b). Instead of a center, the ellipse has two foci; instead of every radius being of equal length (as in the circle), the ellipse's radii vary in length with a minimum (perihelion) and maximum (aphelion); instead of one diameter, the ellipse has major and minor axes.

A self-similar series of expanding circles (c) represents the Riemannian transformation from  $N$  to  $N + 1$ .

are nonlinear processes of this sort. Additionally, at the extremes of scale of astrophysics and microphysics, we are obliged to adduce anything corresponding to an elementary law of nature from nothing but the curvature of physical space-time. Thus, we know that all truly elementary physical functions are of the form of nonlinear propositions within the terms of reference of the Gauss-Riemann complex domain. In the elementary domains of astrophysics, microphysics, and biophysics, no discrete magnitudes exist self-evidently. They exist in the geometric form of construction of singularities from a continuous manifold.

Thus, the derivation of the elementary laws of physics from nothing outside the curvature of physical space-time presents us with a notion of the quantization of physical space-time. This quantization references the generation of discreteness as singularities, and also references the harmonic ordering of variable densities of singularities within a defined interval of action within the continuum. It is only in that sense that I reference the subjects of quantization of space and of nonlinear functions. Up to a point, the

Riemann surface function appears to be an adequate method of representation of nonlinear processes. This function accounts for what must happen in a process to bring about restored connectivity following the earlier appearance of a singularity. However, this representation is an inadequate one, which Riemann's collaborator Beltrami was the first to show in a forceful way.

The problematic issue here is an inadequacy in Dirichlet's topological principle respecting the manner in which connectivity is restored after the generation of a singularity within a Gaussian manifold. It happens that this flaw in the Dirichlet principle is an axiomatic one, and, since the issue of method involved Socratic treatment of axiomatics, the matter is therefore one which is more than merely of great interest to me.

In physics terminology, the Riemann surface function aids us in representing what has happened in the transition from one phase state to the next of a nonlinear process (Figure 4). This representation is true in respect to what we usually reference as weak forces, but is not necessarily true

## Riemannian Geometry, Nonlinearity, and Negentropy

Riemann's most significant contribution was to prove that the standard mathematical methods used in theoretical physics do not work. Riemann's 1859 paper, "On the Propagation of Plane Air Waves of Finite Amplitude," demonstrates how under certain conditions an intense sinusoidal air wave will change its form as it moves, transforming itself into a shock front across which a discontinuous change of pressure occurs (see Figure 4). Up to the point of formation of the shock front, the propagation of the wave appears to be adequately described by the usual differential equations of hydrodynamics. At the formation of the shock front, however, some of the parameters of these equations assume infinite values. The process has assumed new characteristics; a singularity has been formed.

Riemann brings out here the fact that the underlying processes of the universe have the potential to fundamentally change their characteristics of action through the mediation of singularities—what appear in the discrete, visible manifold as "individuals" (a shock wave, for example). At the same time, new potentialities, or degrees of freedom, are opened up for further transformation.

Another example of the same law of the continuous manifold is revealed in the familiar phase changes in matter, like the freezing of water, where the transformation from liquid to solid is accompanied by the appearance of a new singularity-type, the water crystal.

The only admissible basis for geometry is the process by which a manifold of order  $N$  is transformed into a manifold of order  $N + 1$ . The subject of geometry is not a point, nor a line, nor a surface, nor a solid, but the process of transformation from point, to line, to surface, to solid, and so on. In other words, Riemann saw the proper subject of geometry as negentropy.

—Dr. Jonathan Tennenbaum

with respect to what we regard relatively as strong forces. That is the physics side of the matter, which I leave to the ministrations of appropriately qualified colleagues. My approach is a more elementary one.

With those limiting considerations, we may say that the Riemann surface function represents what has happened in such cases, but fails to demonstrate how and why that result must occur. What is the causal agency associated with the existence of a topological singularity we represent loosely as a point or hole, which brings about the transformation the Riemann surface function purports to represent after the fact?

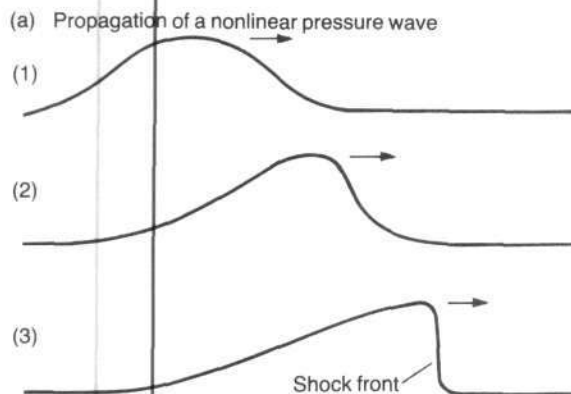
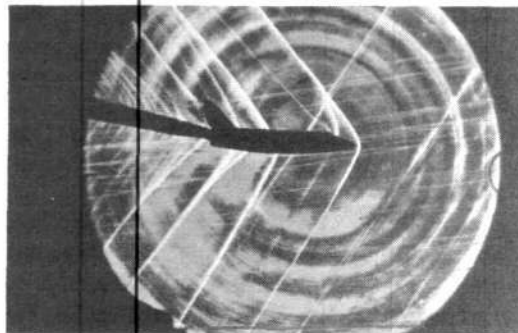

**Figure 4**  
**SHOCK WAVES AND NONLINEARITY**

As a pressure wave travels through air, it takes the shapes in (a). The wave is termed nonlinear because the higher pressure area moves forward faster than the lower pressure area. It tends to lean forward, similar to an ocean wave beginning to break at the beach. In this case, however, the wave forms a sharp front that has a "shock" effect if it hits an obstacle.

The formation of a sonic boom wave at the front of a jet plane traveling at supersonic speed is shown in (b). Moving faster than the speed of sound, the jet piles up the air in front of it, creating a pressure situation similar to the shock in (a).

(b) Formation of sonic boom shock wave



The solution to this problem can lie only within the domain of the constructive geometry of a multiply connected manifold of the Gauss-Riemann sort (Figures 5-6). Thus, the kernel of the point: If it is the case, as Beltrami indicates, that these singularities are not simply points or holes in an otherwise continuously positive curvature, but rather regions of negative curvature, and if we were to discover that such regions correspond to the notion of strong forces, we are then on the track of a solution to this interesting problem of axiomatics.

These considerations ought to turn our attention to certain crucial discoveries effected during the 15th century, to matters bearing upon the complementarity of the tractrix and catenary (Figures 7-8). It appears not only that Brunelleschi was the first to bring the significance of that to our attention, but that the physics of his design for the con-

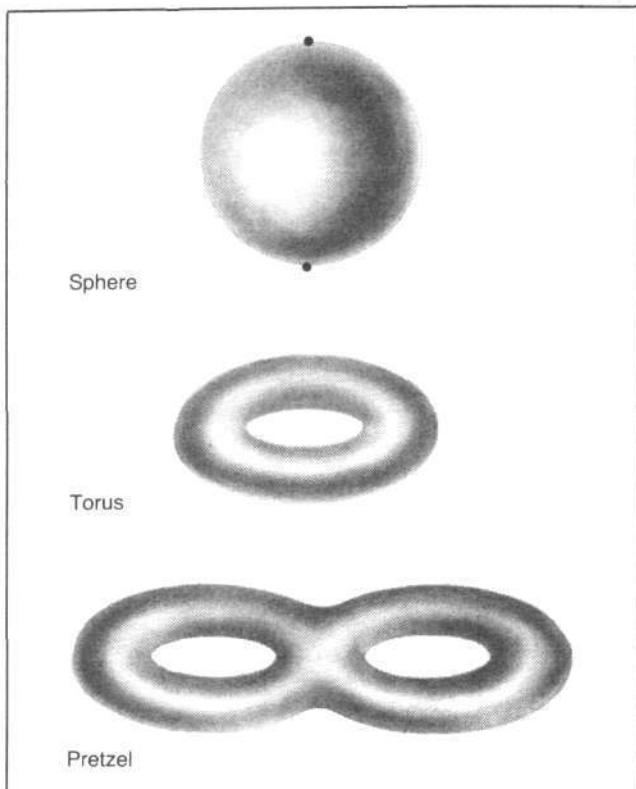

**Figure 5**  
**MULTIPLY CONNECTED SURFACES**

The topology of a sphere has simple connectivity. There are no singularities (holes), only poles. The torus, with its center hole, is doubly connected and a pretzel shape, with two holes, is triply connected. LaRouche cites Beltrami's work to offer the hypothesis that these singularities are not simply points or holes—empty space—in an otherwise continuous positive curvature, but rather regions whose physical geometry is characterized by negative curvature. Further, LaRouche suggests that these regions correspond to the notion in physics of strong forces.

struction of the dome of the cathedral of Florence embodies the application of certain physics implications of this complementarity to applied physics.

The continuation of this line of inquiry by Leonardo da Vinci, and the outgrowths of that in the later work of such as Kepler, Desargues, Leibniz, and Huygens, and such as Monge, Poncelet, and Gauss later, assist us greatly in viewing the internal history of geometrical thinking in modern science from this standpoint of reference.

I make two general points in conclusion.

First, I emphasize that my refutation of Kant's dogmas, as represented in sundry published locations, defines the kinds of creative mental processes associated with valid fundamental discoveries with a form of nonlinear process in which all the problems I have listed are central features.\* I have also emphasized, that the rigorous scrutiny of the methods of composition employed in great works of strictly classical art forms represent, from the axiomatic stand-

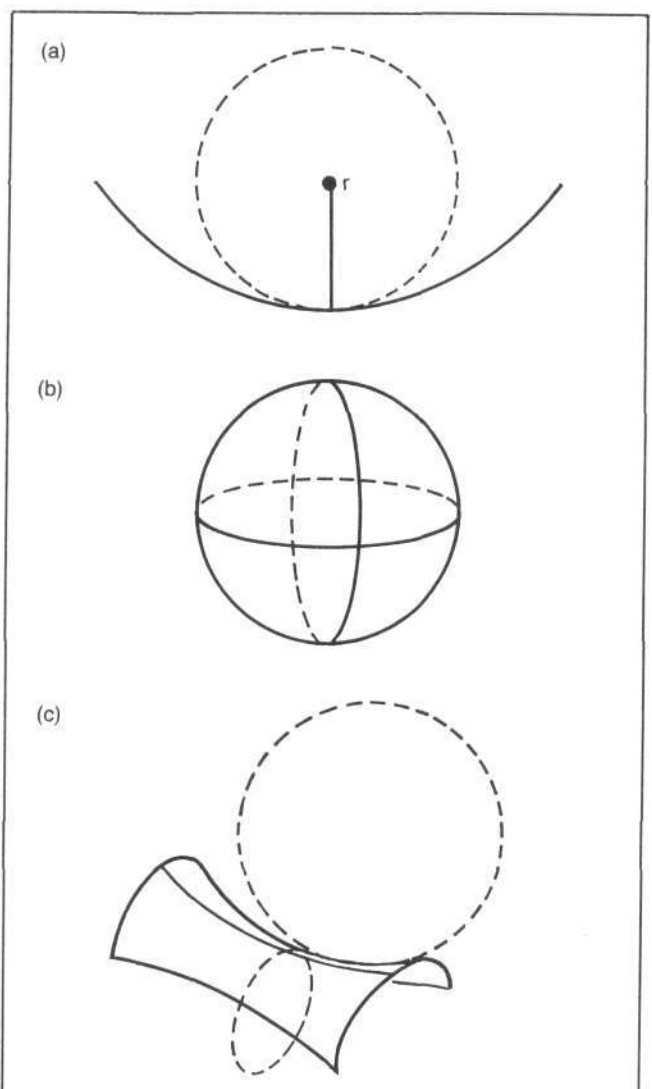

**Figure 6**  
**CURVATURE: NEGATIVE AND POSITIVE**

Curvature is measured by the radius of a circle that most approximates a curve (a). On a surface, the curvature is measured by two such circles approximating the curvature at the maximum and minimum extremes. These extremes, it turns out, are always perpendicular.

The curvature of a surface is positive when these two curves lie on the same side of the surface, as in a sphere (b) or a torus. On a surface of negative curvature the two circles will lie on opposite sides of the surface, as in the saddle curve (c).

point, directly the same quality and form of creative mental activity we encounter in the case of a valid fundamental discovery in physical science.

#### The Process of Scientific Discovery

From this vantage point, and the methodological vantage point of Cusa's *De Docta Ignorantia*, the essence of science

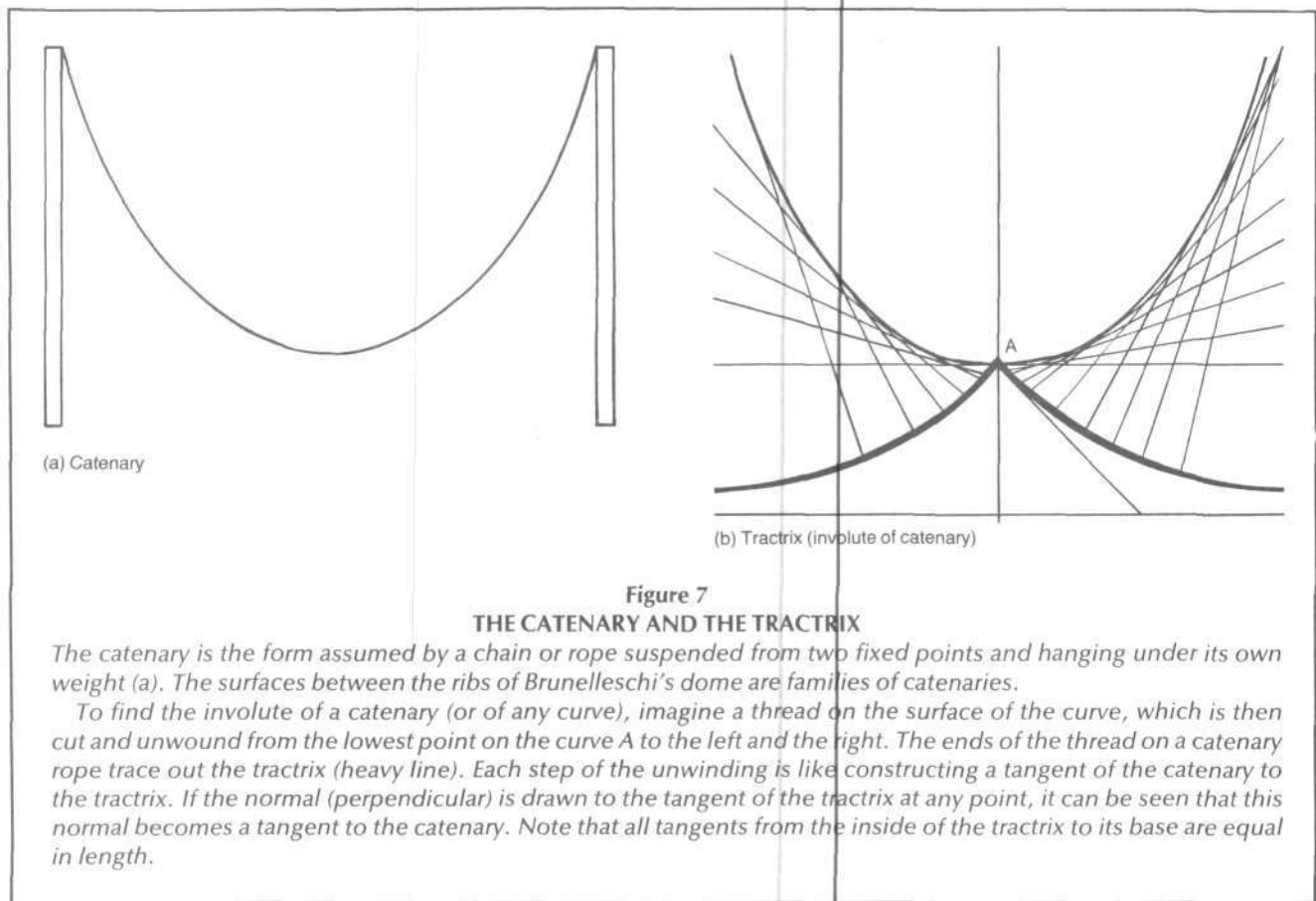

**Figure 7**  
**THE CATENARY AND THE TRACTRIX**

The catenary is the form assumed by a chain or rope suspended from two fixed points and hanging under its own weight (a). The surfaces between the ribs of Brunelleschi's dome are families of catenaries.

To find the involute of a catenary (or of any curve), imagine a thread on the surface of the curve, which is then cut and unwound from the lowest point on the curve A to the left and the right. The ends of the thread on a catenary rope trace out the tractrix (heavy line). Each step of the unwinding is like constructing a tangent of the catenary to the tractrix. If the normal (perpendicular) is drawn to the tangent of the tractrix at any point, it can be seen that this normal becomes a tangent to the catenary. Note that all tangents from the inside of the tractrix to its base are equal in length.

is not particular knowledge, which is always historically ephemeral in its authority, but rather the process of perfection of the mental powers developed for the work of scientific discovery. In other words, relative to the notions of finiteness associated with formal analysis of the discrete manifold, the active principle of scientific progress is not deductive, but is a transfinite implicitly representable by the kind of nonlinear process indicated.

Hence, in dealing with the axiomatic issues of science, we must adopt the appropriate historical approach to the internal history of science. We must reexamine the branching points in the internal history of science, at which certain axiomatic sorts of ontological assumptions were adopted, and must reexamine the historical issues so posed in terms of reference to new qualities of experimental evidence presently confronting us.

Thus, by reliving the mental experience associated with the most crucial discoveries of a past reaching not too infrequently into 15th-century Italy, we clear confusion from our minds, and approach present-day questions in a fresh way.

Thus, always, when we honor the best contributions of the past, we strengthen the means for solving important tasks of the present.

*Lyndon LaRouche, an economist and controversial political figure, frequently writes on the important scientific tasks of the present.*

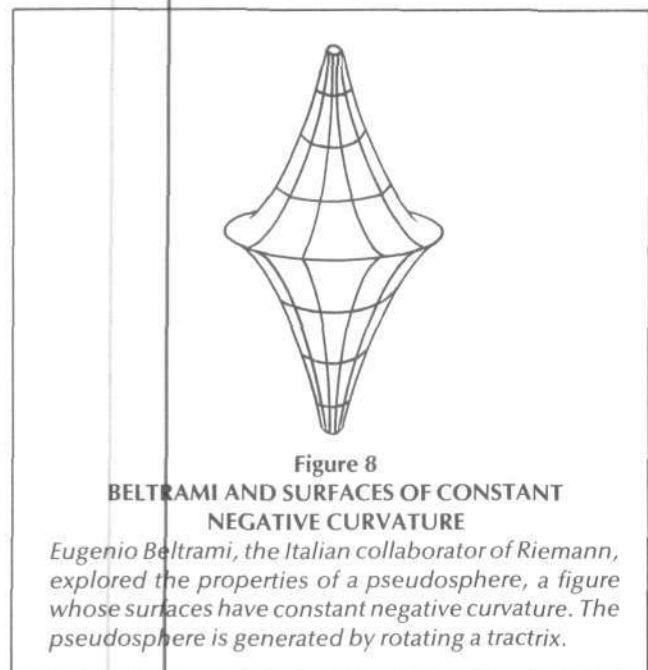

**Notes**

\* For example, see "Designing Cities in the Age of Mars Colonization," *21st Century*, Nov.-Dec. 1988, pp. 26-48.



# Was AIDS Deliberately Created?

by John Grauerholz, M.D.

*The shocking charge raised by a civil rights leader that AIDS was developed as a race-specific population control measure is examined in detail by a medical expert.*

**T**oday we face a worldwide epidemic of a lethal, incurable disease with the potential to destroy most, if not all, of the human race. AIDS is now spreading most rapidly in Africa and among racial and ethnic minorities in the United States. At the same time, there is increasing pressure for the reduction of populations throughout the world as a means of reducing financial costs and increasing "wilderness."

The chairman of the National Council of Public Auditors, Samuel Evans, a long-time civil rights leader, has called for an investigation of allegations that the AIDS virus, HIV, was developed as part of a project to produce so-called ethnic, or race-specific, biological warfare weapons.<sup>1</sup> The purpose of such weapons would be the elimination of specific targeted populations, such as blacks or other nonwhite peoples. The charge is shocking, but before dismissing it out of hand as "paranoia" or "conspiracy theory," it would be well to ask and answer a number of pertinent questions.

Is it possible to develop biological agents with the desired specificity? Are there persons with the motive to develop and use such weapons, assuming the possibility of doing

so? If such persons do exist, do they now have, or have they had, the opportunity to do so? If all three questions can be answered "yes," then Evans's request is not only reasonable, but absolutely compelling.

As to the intent to develop such weapons, the following statement to a congressional hearing by an official of the Department of Defense in 1969 is relevant:

Within the next 5 to 10 years, it would probably be possible to make a new infective microorganism which could differ in certain important respects from any known disease-causing organisms. Most important of these is that it might be refractory to the immunological and therapeutic processes upon which we depend to maintain our relative freedom from infectious disease.<sup>2</sup>

In other words, the possibility of creating a virus like AIDS was acknowledged. Just three years later, the World Health Organization indicated in a proposal for research the same possibility—creation of a virus that would impair the immune system:

(1) A systematic evaluation of the effects of viruses on immune functions should be undertaken. A number of viruses should be studied and a standard set of immune functions should be employed. Among the factors that deserve investigation are antigen types (e.g., thymus-dependant vs. non-thymus dependent), antigen dose, and the time relation between infection and antigen administration.

(2) The effects of virus infection on different cell types (e.g., macrophages, T and B lymphocytes) should be studied in greater detail with morphological changes perhaps serving as an indicator of functional alteration. Since differences in terminology often make it difficult to assess reports of pathological changes in lymphoid tissue, all modifications should be described according to standardized criteria. Efforts at standardization are currently being supported by the World Health Organization.

(3) An attempt should be made to ascertain whether viruses can in fact exert selective effects on immune function, e.g., by depressing 7S vs. 19S antibody, or by affecting T-cell function as opposed to B-cell function. . . . The possibility should also be looked into that the immune response to the virus itself may be impaired if the infecting virus damages more or less selectively the cells responding to the viral antigens. . . .<sup>3</sup>

WHO's research proposals and the link to AIDS did not go unnoticed. In *Bio-Attack Alert*, Theodore A. Strecker, a Los Angeles lawyer, and Dr. Robert B. Strecker, a Los Angeles physician and pharmacologist, wrote of WHO's proposals:

Thus AIDS today is the disease the possibility of which was "to be looked into" in 1972, because in AIDS the immune response to the virus is impaired when a portion of the cells responding to the viral antigens are the infected cells which are killed, "lysed" in virologists' terms, by the viral antigen. *Let there be no question that infection was intended because a part of the study was to be the time relationship between infection and antigen administration* [emphasis in original].

How was the study to be conducted in humans? The Fogarty International Center *Proceedings* No. 15, published in *Federation Proceedings*, Vol. 31, No. 3, May-June 1972, reports the proceedings of a workshop held at the National Institutes of Health, Bethesda, Maryland, July 27-30, 1970. The conference was sponsored by the John E. Fogarty International Center for Advanced Study in the Health Sciences and the World Health Organization. At that conference in a histocompatibility workshop, D.B. Amos of Duke University with other allegedly independent scientists and bureaucrats, who in fact were and are dependent upon United States government grants to further their research, suggested: "In relation to the immune response, a number of useful experimental approaches can be visualized. One would be a study of the relation-

ship of HL-A type to the immune response, both humoral and cellular, to well defined bacteria and viral antigens during preventive vaccinations. This approach would be particularly informative when applied to sibships."

. . . Therefore it is clear that WHO and the NIH decided in 1970 to inject known virus and bacteria into children of the same parents during allegedly preventive vaccinations to study HL-A type. Then in 1972 the WHO *Bulletin* changed the study to a study of virus which cause a depression in immune function. I repeat, *let there be no question that infection was intended because a part of the study was to be the time relationship between infection and antigen administration* [emphasis in original].<sup>4</sup>

#### AIDS: Created in a Laboratory?

It is highly probably that the Human Immunodeficiency Virus (HIV) originated in a laboratory or a number of laboratories.<sup>5</sup> To the present date, no one has satisfactorily determined a natural source for this virus. More to the point, there is abundant evidence in the published scientific literature that such an origin is possible and, in fact, has occurred. Briefly, the facts are as follows.

In 1972, van der Maaten and his colleagues described a virus of cattle, which they called bovine visna virus because it resembled a virus of sheep called visna virus. Visna is a retrovirus that is very similar to the AIDS virus, HIV, and produces a degenerative disease of the nervous system similar to AIDS dementia in humans. It also produces a primary lung infection in sheep that is markedly similar to the chronic lymphoid interstitial pneumonitis (CLIP) that HIV produces in human beings. This visna virus was responsible for an epidemic of slow virus disease that devastated the sheep population of Iceland over the 20-year period from the 1930s to the 1950s.

In 1978, the Polish virologist J.A. Georgiades and his colleagues demonstrated that human leukemia cells could be infected in culture with bovine visna virus. In addition, the phenomenon of infecting cells of one animal species with retroviruses specific for another species had been repeatedly demonstrated in laboratories around the world. Such viruses would lose their ability to infect the species from which they had come and would develop a preference for cells of the new species. Such "species jumps" occur only rarely in nature.

Subsequently, other researchers examined bovine visna virus and determined that it so strongly resembled human immunodeficiency virus (HIV) that they renamed it bovine immunodeficiency-like virus (BIV). The problem is that this virus was a known contaminant of the standard virus and tissue culture medium used in laboratories around the world. This liquid, known as *fetal calf serum*, is collected from unborn calves in slaughterhouses. If the calves are infected with BIV, then the virus will be present in the serum.

Thus, any human tissue culture cells grown in such serum will be infected with the virus and can give rise to strains of virus that will infect human cells.



virus to change both species and cell specificity. In other words, viruses that have crossed from one species to another in nature tend to infect similar cells in the new species. However, the evolution of new species of microbes can be markedly accelerated under laboratory conditions where a desired mutant can be selected and propagated very efficiently.

The question of cell specificity is crucial to the issue of developing a virus targeted at a specific racial or ethnic group. If there were a cell surface marker characteristic of a specific racial or ethnic group, or even just highly prevalent in that group as opposed to others, and a virus could be developed that preferentially bound to such a cell surface molecule, then such a virus would have its most profound effect in that group.

One such surface marker, group-specific component, appeared to bear some relation to the development of AIDS. A study published in the medical journal *Lancet* in 1987 indicated that a genetic variant of this molecule, found in high concentration in African blacks, was associated with increased rate and severity of HIV infection and development of AIDS. Subsequent studies failed to confirm this, and it now appears that the results of the original study were the product of an equipment malfunction in the laboratory.

It has been alleged that the membranes of T-cells in blacks are more porous and hence such cells are more easily infected than those of other racial groups. Interestingly, there appears to be no racial difference in susceptibility of monocyte-macrophages to HIV infection. This would indicate that blacks would be more susceptible to the T-cell effects of HIV infection—which is to say, the development of immune deficiency—whereas AIDS dementia, which is mediated by the monocyte-macrophage system, would affect all races more or less equally.

Actually one does not have to postulate a genetic difference between blacks and other races to account for the disproportionate incidence of AIDS in the black population both in the United States and in the developing sector. The T-cell functions as the coordinator of the immune response to many infections and is activated by diverse immune challenges, such as multiple infections. One of the initial responses to any infection is activation of T-cells and such activated T-cells are especially susceptible to infection, and destruction, by HIV. Thus, any population that is exposed to chronic immune challenge, with resulting T-cell activation, will be more susceptible to development of AIDS after HIV infection. In fact, a study in the *Journal of the American Medical Association* demonstrated a marked similarity of the immune systems of homosexuals and central African blacks.<sup>6</sup>

This similarity between racially diverse groups is rather easily explained by the fact that both groups are exposed to multiple infections with viruses, bacteria, and intestinal parasites: the Central Africans because of the appalling conditions under which they live, thanks in no small part to the stringent austerity of International Monetary Fund conditionalities imposed on their economies; and the homosexuals because their so-called lifestyle effectively breaks down the normal barriers that sanitary engineering erects between what we eat and what we excrete.

In the early 1970s, a group of Soviet virologists headed by the late Victor Zhdanov claimed to have isolated a retrovirus from human leukemia cells. Two papers in which this claim was made both ended with the cryptic comment that the virus might represent a contaminant of the calf serum in which the cells were grown. In retrospect, it appears that the Soviets had unknowingly anticipated Georgiades's 1978 demonstration that bovine visna virus could grow in human leukemic cells.

It would seem that the opportunity for the development of forms of BIV capable of infecting human cells occurred hundreds or thousands of times over the last 20 to 30 years in the course of cell culture work in many laboratories. More to the point, the same fetal calf serum is used for culturing viruses for vaccine production. Such contaminated vaccines could explain the emergence, accidentally or intentionally, of AIDS among vaccinated populations in Central Africa or elsewhere.

The naturally occurring visna virus infects a group of cells known as monocyte-macrophages. HIV infects monocyte-macrophages as well as another group of cells known as T-lymphocytes. This would necessarily result from infection of cultures of human T-cells with visna type viruses, whereas it would be distinctly unusual for a naturally occurring



### The Hepatitis Model

An epidemiological model already existed for a disease that would selectively target homosexuals, IV drug users, hemophiliacs, and central African blacks. This disease is hepatitis-B, so called serum hepatitis, which is primarily spread by infected blood but is generally endemic in the populations of areas like central Africa. A similar blood-borne virus, like HIV, introduced into such populations could be expected to proliferate rapidly. A number of scientists—including Dr. Baruch Blumberg, who won the Nobel Prize for discovering the virus of hepatitis-B—believe the virus is spread by biting insects in areas where there is a high prevalence of infection and many biting insects.

The point is that the introduction of a blood-borne virus with a specific T-cell effect into populations with chronic T-cell activation, from whatever cause, would result in rapid dissemination of infection in those populations and at least an initial concentration of disease in the same populations. This may be relevant to the fact that AIDS initially was no-

ticed in homosexuals in New York City and then slightly later in San Francisco and Los Angeles. If we look at the experimental hepatitis vaccine trials that were conducted among cohorts of homosexual men in those cities, there is an interesting correlation between the vaccine trials and the outbreak of AIDS in the homosexual population.

Studies of hepatitis B as a "gay" sexually transmitted disease began in the middle 1970s and the cohorts of homosexual men in the hepatitis studies ultimately became the epidemiological model for AIDS in the United States. The subjects were required to be young, healthy, and promiscuous, in order to ensure that they were at high risk for acquiring hepatitis B. They were required to receive three injections and donate blood 10 times. It was these blood samples that subsequently provided the initial data on the time between seroconversion and the development of AIDS.

The New York City trials began in November 1978, and in 1979, doctors in Manhattan first began recognizing so-called gay cancer among their homosexual patients. In

## How AIDS Spread in New York's Ghettos

The rapid spread of poverty, drugs, and AIDS was not simply a "natural" occurrence. As outlined by Roderick Wallace, a member of the Department of Epidemiology and Social Medicine at the Albert Einstein College of Medicine in New York, "contagious urban decay" was the outcome of a deliberate policy of "planned shrinkage" for New York City's poorer neighborhoods in the 1970s.

To further this "planned shrinkage," overall management of New York's Fire Department was turned over to the New York City Rand Institute, a Rand Corporation offshoot. Beginning in 1972, fire stations were intentionally closed in targeted ghetto areas, and these neighborhoods then were burned out, as predicted.

Wallace demonstrates how this Rand policy of "planned shrinkage" triggered "contagious urban decay" in his 1988 study, "A Synergism of Plagues: 'Planned Shrinkage,' Contagious Housing Destruction, and AIDS in the Bronx," published in *Environmental Research* (47:1, 1988). Using the Bronx for a case study of a nationwide phenomenon, Wallace shows how when fires break out, people are driven into other neighborhoods, thus increasing overcrowding. Crowded housing leads to more fires and abandonment of yet more housing by terrified inhabitants, who flee to other areas. This process spread the drug plague—initially concentrated in the South Bronx—throughout the Bronx.

The spread of drugs, Wallace says, is ordinarily contained by a kind of social immune system, a network of personal relationships mediated by churches, clubs, schools, and community groups. Contagious urban decay destroys these networks, resulting not only in accelerated drug addiction, but in skyrocketing rates of homicide, infant mortality, and, most recently, AIDS.



Phillip Ulanowsky

*Burnt out: The South Bronx in the 1970s.*

The forced migration of populations mixes intravenous drug users into previously relatively drug-free populations. This accelerates the spread of AIDS. By early 1987, the level of AIDS among males 25 to 44 years old in the South Bronx had risen into the range of 8 to 22 percent, comparable to urban centers in Central Africa.

Since AIDS is not spread only by sex and dirty needles, but thrives on overcrowding, poverty, and filth, Wallace's chain of cause and effect is all the more obviously correct. In 1988, AIDS was the third leading cause of death in New York City as a whole, and the leading cause of death among men aged 30 to 44 and women aged 25 to 39, according to a statement to the press by New York City Health Commissioner Stephen Joseph, Jan. 23, 1989.

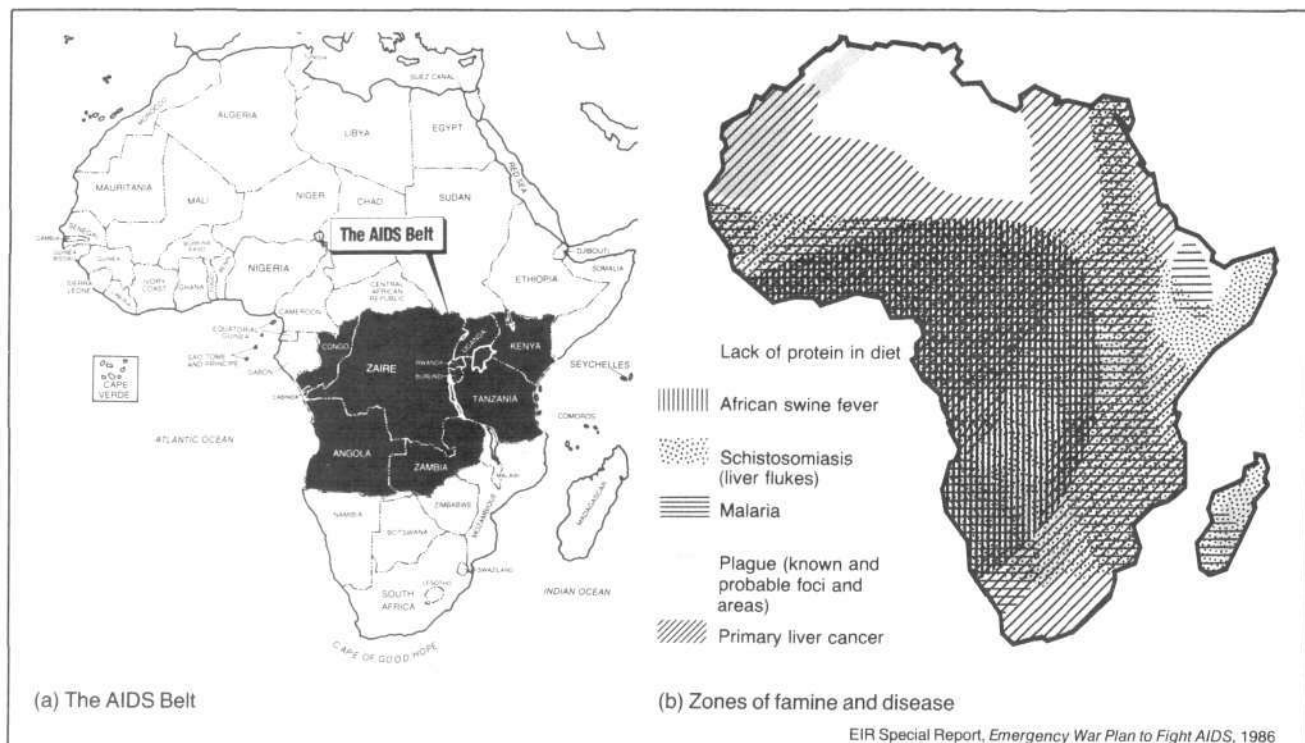

**Figure 1**  
**AFRICA'S 'AIDS BELT,' FAMINE, AND DISEASE**

*AIDS has spread—and continues to spread—like wildfire throughout Central Africa. The World Health Organization and the U.S. Centers for Disease Control deny that this has anything to do with the poverty, hunger, and disease—meaning lowered resistance—that have ravaged the region, as shown here.*

March 1980, a second study group in Los Angeles, San Francisco, Chicago, Denver, and St. Louis began receiving the experimental hepatitis vaccine and the first homosexual male from San Francisco was diagnosed with AIDS in fall 1980. As Alan Cantwell, M.D., put it in his book, *AIDS and the Doctors of Death*:

The most suggestive evidence was the striking epidemiologic profile of the gay men who had volunteered as guinea-pigs for the experimental hepatitis vaccine injections. *The epidemiologic profile of the gay men was basically identical to the profile of the first AIDS cases that were reported to the CDC.*

According to Cantwell,

*...6.6% of the original group of 212 men who had been injected with the vaccine had AIDS virus antibodies in their blood samples collected during November 1978 and October 1979! This was additional proof that the AIDS virus was "introduced" into the New York City gay community two years before the "official" beginning of the AIDS epidemic in 1981!*

By 1981, over 20% of the original 212 men had a positive virus antibody test; by 1984 . . . over 40% tested positive. Most of these "positive" men were immunodeficient [emphasis in original].<sup>7</sup>

#### Controlling AIDS?

Subsequently, it was discovered that the AIDS infection was spreading rapidly in the predominantly Black and Hispanic intravenous-drug-using populations of New York and New Jersey, as well as in the general population of Sub-Saharan Africa, the so-called AIDS belt (Figures 1-3). The initial reaction of the World Health Organization was to downplay and deny the extent of the problem until it was totally out of control.

In 1985, WHO dispatched a senior official to Africa to assure the governments of the affected countries that there was no problem. After this gentleman returned, horrified by the actual situation, WHO continued to insist that "a global panic and exaggeration about AIDS is disseminating from the country in which AIDS originated—the United States."<sup>8</sup> This latter statement was issued by the Assistant Director General of WHO for Communicable Diseases, Dr. Sergei Litvinov of the Soviet Union. Not surprisingly, Litvinov's previous assignment had been in Africa, where he specialized in the epidemiology of African infectious diseases and ran a population control program funded by the U.S. Agency for International Development.

It is interesting to examine the consequences of the present WHO and Centers for Disease Control (CDC) policy for dealing with the AIDS epidemic, especially the present doctrine of how HIV is—and is not—transmitted. AIDS, we are told, is a lethal, incurable disease transmitted by sex

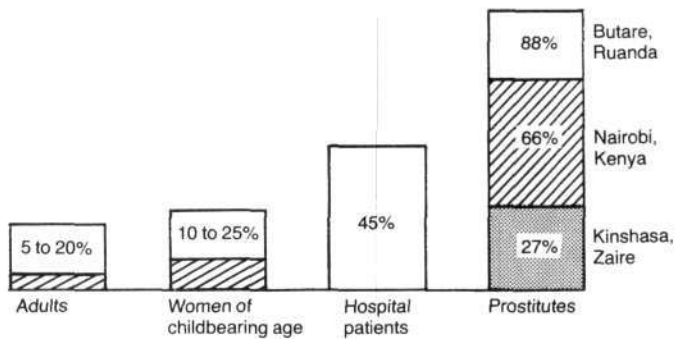

Sources: The estimate for adult population is based on samples from urban centers in the Congo, Zaire, Zambia, Tanzania, Uganda, and Ruanda. Estimates for women of childbearing age and for hospital patients are based on samples from Kinshasa (Zaire), Nairobi (Kenya), and Butare (Ruanda). All figures are from Max Essex and Phyllis Kanki, writing in *Spectrum*, the German edition of *Scientific American*, December 1988.

**Figure 2**  
**AIDS INFECTION RATES IN AFRICAN 'AIDS BELT'**  
**URBAN CENTERS, 1988**

*AIDS is not limited to the urban populations whose infection rates are shown here, although the urban rates are more available and more reliable than country-wide statistics. Satellite photographs in 1987 showed "a large extension of wild vegetation in the eastern part of Zaire. AIDS seems to be the cause of the disappearance of entire communities in those regions, previously densely populated," according to A.J. Venter, writing in the International Defense Review (April 1988). Venter claims that several governments, interested in the vast mineral wealth of Central Africa, are watching this process carefully with a thought to the repopulation of the region with whites. Others—such as a medical authority interviewed in Paris Match, Prof. Bernard Debré—warn that "If Africa is overwhelmed by AIDS, then the West will sink with it."*

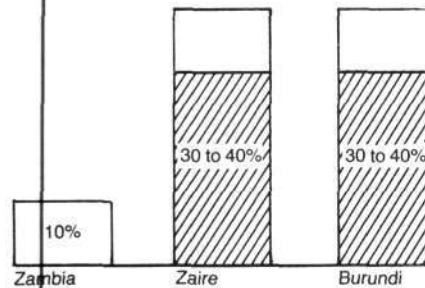

Sources: The Zambia estimate is from WHO (*Financial Times*, April 13, 1989). Estimates for Zaire and Burundi are cited by Prof. Bernard Debré after a conference on AIDS in the Ivory Coast, in *Paris Match* magazine, Feb. 2, 1989.

**Figure 3**  
**AIDS INFECTION RATES IN 'AIDS BELT'**  
**URBAN CENTERS BY COUNTRY, 1988-1989**

and dirty needles, and is in no way related to environmental factors other than the promiscuous behavior of certain "lower" classes. Thus, the accepted program for controlling the disease—and "controlling" is the key operative word—consists of the following:

*Explicit sex education for children.* The threat of AIDS infection is the ultimate battering ram to smash the remaining resistance of parents to frankly pornographic "sexual education" materials. Now sex education is no longer a moral issue, but a matter of life and death.

*Birth control for minorities.* HIV is spreading "heterosexually" like wildfire through Central Africa and through the black and Hispanic populations in the United States. It is being described explicitly as a heterosexually transmitted disease of poor people for which the only answer is condoms. Any relation to the crowded, unsanitary conditions under which these people are forced to live—and which already are responsible for the high death rates among them—is ruled out of order by the public health authorities. AIDS is being looked to as the means by which minority populations can finally be terrified into overcoming their resistance to birth control.

*Homosexual rights.* In one of the more bizarre consequences of the AIDS epidemic, the spread of infection in the homosexual population has been used as the springboard for proselytizing for the homosexual lifestyle and claiming special rights for homosexuals as a persecuted minority. One interesting consequence of this is that the homosexuals, who may well have been targeted as a popu-

lation for this disease, have been successfully manipulated into opposing measures to stop the spread of the infection. As a result, they will probably take the blame for the failure to implement such measures, rather than those who were unwilling to expend the necessary funds for a true public health approach.

*Provision of clean needles.* Since it is undeniable that HIV can be transmitted by intravenous drug abuse, this represents a means by which we can appear to be trying to stop the spread of AIDS without stopping the spread of drugs. Because this is one of the main routes of transmission in the black and Hispanic ghetto populations, and because there is no evidence of serious intent to fight the drug traffic or fund the necessary level of treatment programs, the consequences for the target groups are obvious.

*Euthanasia.* Since AIDS is incurable and extremely unpleasant in its final stages, the idea is to save money and suffering by killing the victims as quickly and as cheaply as possible. For those who see human beings as "costs" instead of assets, this represents an opportunity to extend the benefits of what they term "ethical homicide" beyond deformed infants and the elderly to an entire new segment of the population.

#### Controlling Population

When one examines these measures it becomes evident that whatever their effect on controlling the proliferation of AIDS, they will certainly control the proliferation of population, especially among those most heavily affected. Ev-

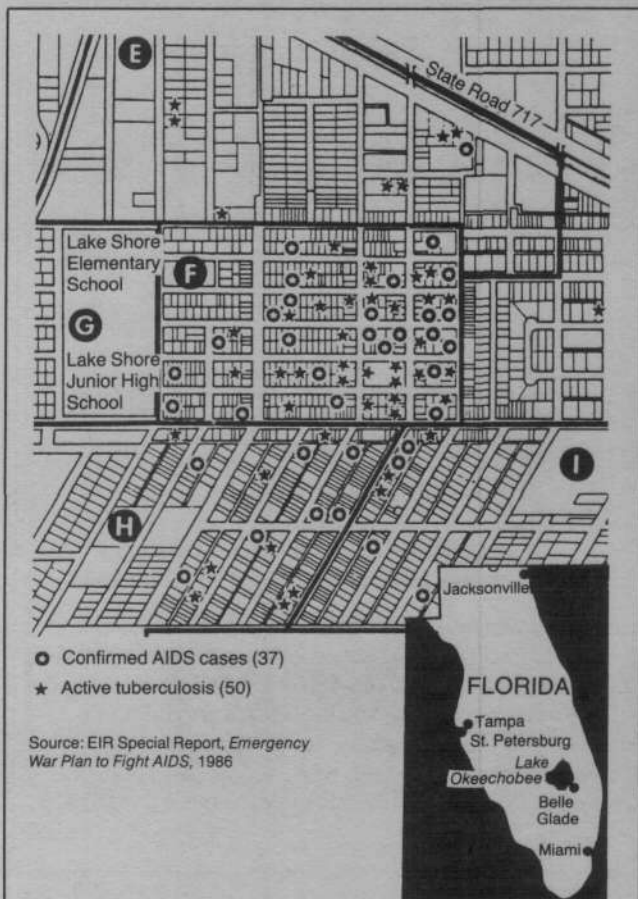

Figure 4

#### TUBERCULOSIS AND AIDS: THE BELLE GLADE CASE

Confirmed cases of AIDS correlate strongly with tuberculosis infection, as shown here for Belle Glade, Fla., August 1985. Belle Glade is a desperately poor town of 20,000 people. All of the AIDS patients here have had long-term residence in central depressed neighborhoods where incidence of diseases, including tuberculosis, is high. Only half of these Belle Glade AIDS cases fell into the so-called risk groups. The other half were persons of no identifiable risk (NIR) or Caribbean-born individuals. The same pattern has been emerging elsewhere in south Florida and elsewhere in the United States.

The Belle Glade case was uncovered through the work of Drs. Mark Whiteside and Caroline McLeod, codirectors of the Institute of Tropical Medicine in Miami, after which the CDC commissioned studies to "prove" that there was no environmental basis for the spread of AIDS, and to assign Belle Glade cases of no identifiable risk to various risk groups. The CDC also fired Health Officer Gus Sermos for showing too much interest in documenting AIDS cases, in Belle Glade in particular.

Two recent studies, reviewed in the Executive Intelligence Review (Feb. 3, 1989, p. 4), show a direct relationship between malnutrition and AIDS and between tuberculosis and AIDS.

ery one of these measures will either reduce the birth rate or increase the death rate among the populations to which they are applied.

In this light, it becomes quite evident why those who uphold the official policy on AIDS cannot tolerate the idea that environmental conditions can be a factor in the transmission of HIV or development of disease, despite the evidence that this is the case. (See Figures 1 and 4.) Namely, if poverty per se, or malnutrition, or poor sanitation were a significant factor in the spread of AIDS, then that would require repairing those environmental conditions. However, such an intervention would almost certainly create the conditions for a decreasing death rate or, horror of horrors, an increasing birth rate, with a resultant increase of population.

Are there persons with the motive to develop and use such biological weapons? As the following statements from noted individuals indicate, there certainly are. The British aristocrat, philosopher, and socialist Bertrand Russell wrote in his 1953 book, *The Impact of Science on Society*:

At present the population of the world is increasing at about 58,000 per diem. War, so far, has had no very great effect on this increase, which continued throughout each of the world wars. Until the last quarter of the nineteenth century this increase was more rapid in advanced countries than in backward ones, but now it is almost wholly confined to very poor countries. . . .

I do not pretend that birth control is the only way in which population can be kept from increasing. There are others, which, one must suppose, opponents of birth control would prefer. War, as I remarked a moment ago, has hitherto been disappointing in this respect, but perhaps bacteriological war may prove effective. If a Black Death could be spread throughout the world once in every generation survivors could procreate freely without making the world too full. There would be nothing in this to offend the consciences of the devout or to restrain the ambitions of nationalists. The state of affairs might be somewhat unpleasant, but what of it? Really high-minded people are indifferent to suffering, especially that of others.<sup>9</sup>

Earlier, in *The Prospects of Industrial Civilization* (1923), Russell had written:

The white population of the world will soon cease to increase. The Asiatic races will be longer, and the negroes still longer, before their birth rate falls sufficiently to make their numbers stable without help of war and pestilence. . . . Until that happens, the benefits aimed at by socialism can only be partially realized, and the less prolific races will have to defend themselves against the more prolific by methods which are disgusting even if they are necessary.<sup>10</sup>

In a similar vein, H.G. Wells, the publicist for British imperial policy, wrote in *Anticipations of the Reaction to Mechanical and Scientific Progress Upon Human Life and Thought* (1902):

The men of the New Republic [the utopian nation he created] will not be squeamish either in facing or inflicting death. . . . They will have ideals that will make killing worthwhile. . . . They will hold that a certain portion of the population exists only on sufferance out of pity and patience, and on the understanding that they do not propagate; and I do not foresee any reason to suppose that they will hesitate to kill when that sufferance is abused.<sup>11</sup>

H.G. Wells was a protégé of Thomas Huxley, the foremost propagator of the theory of natural selection ("survival of the fittest"), the basis for so-called scientific racism and eugenics. Wells, in turn, initiated Huxley's grandsons, Aldous and Julian, into the racist elite personified by Bertrand Russell. Aldous Huxley credits Wells with introducing him to his mission in life, the creation of the drug counterculture. One of Aldous Huxley's more notorious operations was as a coordinator of Bertrand Russell's MK-Ultra project for the mass drugging of American youth in the 1960s, using LSD and marijuana.

Another joint project of Aldous Huxley and Bertrand Russell was the Reverend Jim Jones. Jones's cult, which was based on work done by Huxley and LSD guru, Dr. Timothy Leary from Harvard University, was essentially an experiment in the induction of mass suicide, specifically among the poor and disadvantaged.

Julian Huxley was regarded as Aldous's "straight" brother, but the genocidal goals of his work were identical to those of the more picturesque Aldous. He was a close collaborator of J.B.S. Haldane and Bertrand Russell in the post-war Pugwash Movement to induce scientists to reject nuclear defense and nuclear power. Julian and Haldane also intervened into the Soviet Lysenko controversy to attack Soviet science as incompetent. His most important assignment, however, was the directorship of the United Nations Economic, Social, and Cultural Organization (UNESCO), established as the international medium for the propagation of Wells and Russell's antiscience ideology and population control programs. As UNESCO's first director from 1946 to 1948, Huxley established British feudalist policy as the foundation of the organization.

UNESCO became the mother institution for the environmentalist movement, putting forward the racist doctrine that the developing sector should be given only "appropriate technology"—appropriate to feudalism, that is, windmills and solar power—rather than industry. Through UNESCO's avowed "aid for national liberation movements," the organization admits to conducting \$2.1 million to such movements in the fiscal year 1979. And it is under the auspices of UNESCO that mass sterilization drives were launched throughout Asia and Latin America.

Another United Nations-associated organization that has had substantial impact on the developing sector is the World Bank. In fact it is the World Bank that is the enforcer of the "appropriate technology" doctrine. Since Robert McNamara assumed the presidency of that body in 1973, it has been the major engine for depopulation in the developing sector, especially in those areas described by McNamara as "the Fourth World." These are precisely the areas—South

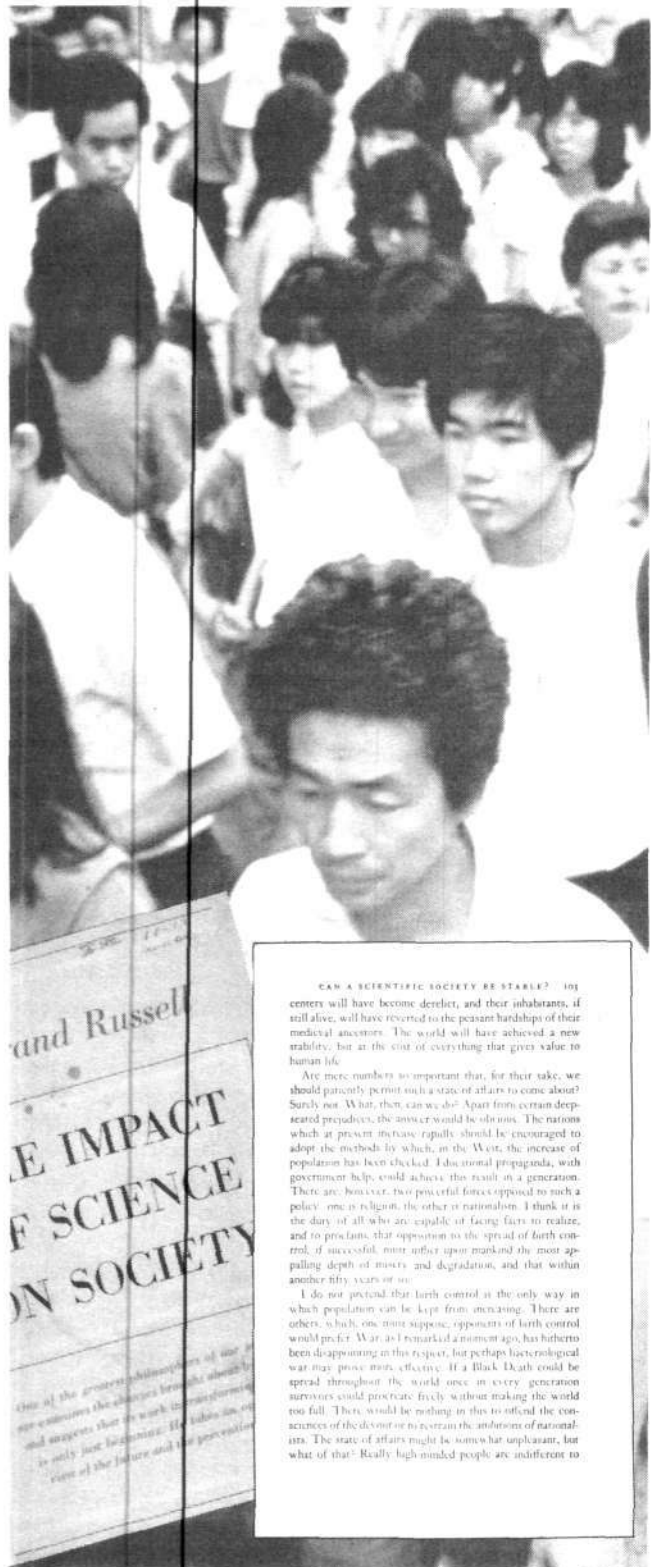

CAN A SCIENTIFIC SOCIETY BE STABLE? 101  
centers will have become desolate, and their inhabitants, if still alive, will have reverted to the peasant hardships of their medieval ancestors. The world will have achieved a new stability, but at the cost of everything that gives value to human life.

Are mere numbers so important that, for their sake, we should patiently permit such a state of affairs to come about? Surely not. What, then, can we do? Apart from certain deep-seated prejudices, the answer would be obvious. The nations which at present increase rapidly should be encouraged to adopt the methods by which, in the West, the increase of population has been checked. Educational propaganda, with government help, could achieve this result in a generation. There are, however, two powerful forces opposed to such a policy: one is religion, the other is nationalism. I think it is the duty of all who are capable of facing facts to realize, and to proclaim, that opposition to the spread of birth control, if successful, must inflict upon mankind the most appalling depth of misery and degradation, and that within another fifty years or so.

I do not pretend that birth control is the only way in which population can be kept from increasing. There are others, which, one must suppose, opponents of birth control would prefer. War, as I remarked a moment ago, has hitherto been disappointing in this respect, but perhaps bacteriological war may prove more effective. If a Black Death could be spread throughout the world once in every generation survivors would procreate freely without making the world too full. There would be nothing in this to offend the consciences of the devout or to curtail the ambitions of nationalists. The state of affairs might be somewhat unpleasant, but what of that? Really high-minded people are indifferent to

Carlos de Hoyos

*Bertrand Russell threatened in *The Impact of Science on Society* (1953) that if governments did not stop population growth with birth control, germ warfare would be used to accomplish the same result within about 50 years—and those who had resisted birth control would be blamed.*

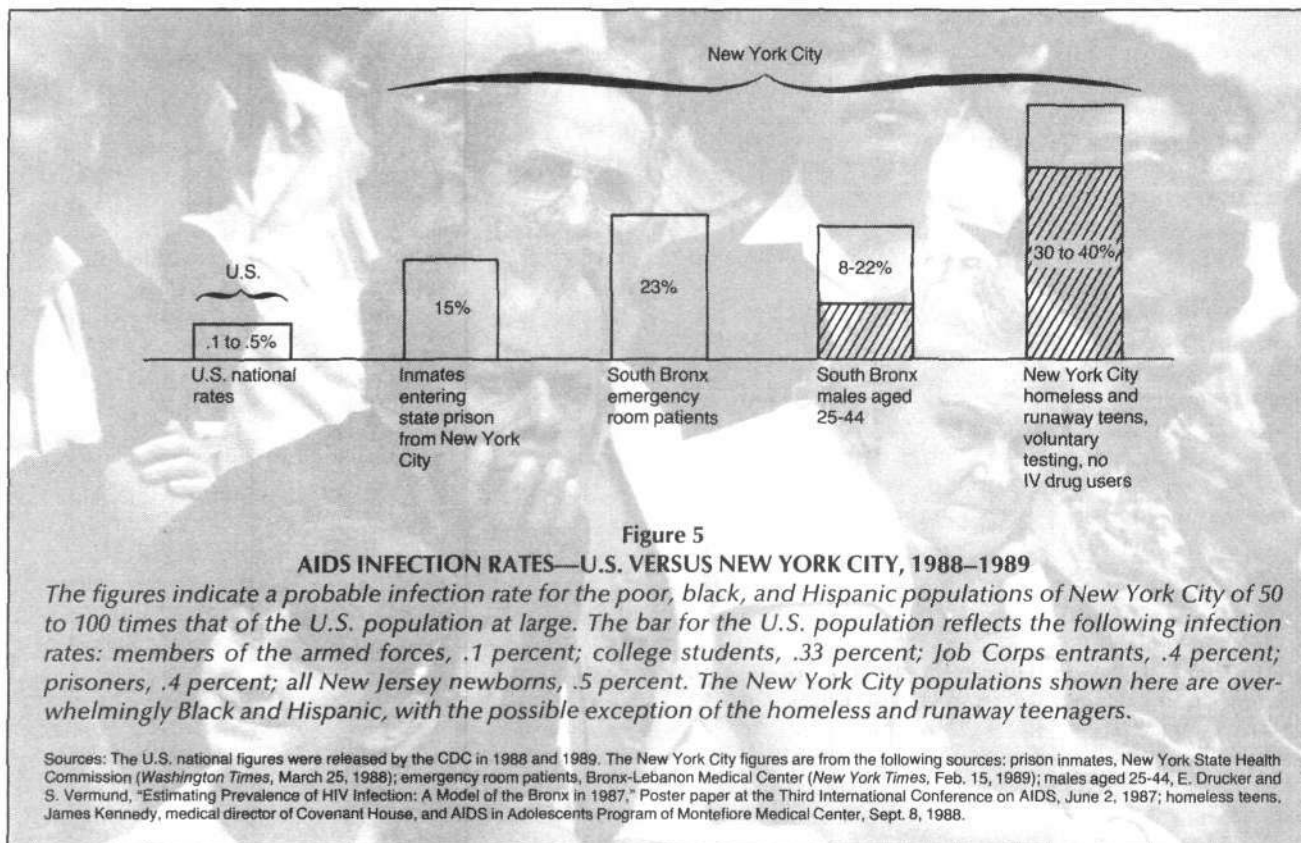

Carlos de Hoyos

and Central America and Central Africa—where AIDS is rapidly spreading among the populations that McNamara proposed to "triage." In the United States, the analogous domestic policy toward the black and Hispanic populations was Senator Daniel Patrick Moynihan's "benign neglect" policy of the mid-1960s.

The most obvious United Nations agency involved in the AIDS epidemic is of course the World Health Organization headquartered in Geneva. This project of Julian Huxley, among others, was created to control the distribution of health care resources throughout the world and has always considered population control as the chief item on its agenda.

It was WHO, in its 1978 Conference on Primary Health Care, held in Alma Ata, that mandated that no major capital investments in health care and sanitary infrastructure would be made in the developing nations. Instead, the model was to be "Health for All" by the year 2000, to be delivered by "primary health care providers" that is, village health officers, midwives and witch doctors (euphemistically termed "indigenous healers"), and "clean your own latrine" sanitation projects. Rather than a commitment to eliminate disease (other than the smallpox eradication program, which WHO's Litvinov supervised and which may have ignited the AIDS epidemic in Africa) that would require economic development and development of infrastructure, WHO chose a policy of "peaceful coexistence" with disease, based on "crisis management" and control. "Control" in this case means the confinement of the disease to certain populations.

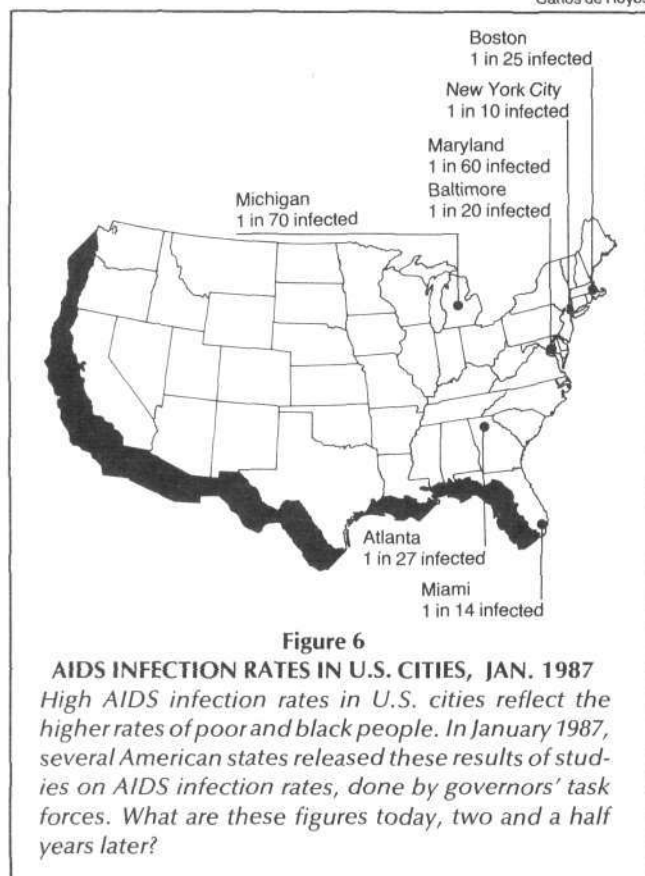

## Congress Asked to Investigate AIDS As a Population Weapon

Here are excerpts from a letter by Samuel L. Evans, Chairman of the National Council of Public Auditors, sent in February 1989 to members of the Congressional Black Caucus, the Speaker of the House of Representatives, and many others.

Dear Congressman:

This may well be one of the most important letters you will receive during your lifetime. . . . I address this letter to you requesting a Congressional investigation into the "allegations" that our government is financing research and development through genetic heredity engineering—to multiply certain viruses to kill specific racial groups . . . blacks, Jews, gays, and other "non-Aryans" with an agenda of: global depopulation, emphasizing Africa and Asia.

The multitude of allegations, statements, news articles and personal testimony demands prompt clarification. For instance, it is alleged:

1. That Col. David L. Huxsoll, commander of the U.S. Army Research Institute of Infectious Diseases at Fort Detrick, Md., has received \$60 million for research in biological ethnic weapons.

2. That it might be possible to wage ethnic warfare by developing substances that affect one race more than another. According to *Newsweek* magazine, Jan. 16, 1989, an example would include "Valley fever, which is much more likely to kill blacks than whites." Another substance, developed at a southern California universi-

ty, is believed to kill only people with melanin in their skin.

3. That it is a coincidence that Fort Detrick, which is where Col. Huxsoll's biological warfare research is being conducted, is also the site of AIDS research.

4. That this coincidence fuels the rumor, whether true or not, that the AIDS virus was genetically engineered at Fort Detrick and intended for extermination and depopulation as outlined above.

5. Further, it is alleged that Michael Meiers, an engineer, stated in his new book that the development of ethnic weapons . . . is a reality, and listed factions within the CIA as participants. . . . Also, a former chief of the U.S. Army Chemical and Biological Warfare Division, whom Meiers named, is said to have cultured the AIDS virus.

6. That Zaire in Africa, as well as surrounding states, was targeted for the first experiment, and anywhere from 20 to 30% of the population has been infected with the AIDS virus. . . .

These allegations go to the very root of our constitutional form of government and basic world human rights, and must be responded to by elected governmental officials on all levels. Nothing less than a Congressional hearing and investigation that may lead to a full world conference in the United Nations is needed to clarify and defuse the alleged mentally deranged plan of world depopulation by ethnic weapons through genetic engineering and prevent world panic and fear. . . .

Another organization that closely overlaps the United Nations, the World Health Organization, and UNESCO is the global forum of pacifist scientists, Pugwash. Pugwash was a joint project of Bertrand Russell and Leo Szilard, a physicist and later microbiologist. Szilard, who was the actual model for the demented Dr. Strangelove in the Stanley Kubrick film, was the architect of the post-World War II "balance" of nuclear terror. Writing in the October 1955 issue of the Pugwash publication, the *Bulletin of the Atomic Scientists*, Szilard states:

Another problem that must be solved is the problem of population control in the underdeveloped areas. There is no need for us to be concerned . . . about the political, social, and religious obstacles that today may seem to stand in the way of solving this problem.

From this brief account of the evidence, it is obvious that it was indeed possible to create the AIDS virus in a laboratory, that an epidemiological model for targeting the specific groups affected by AIDS existed, and that individuals and institutions with both motive and opportunity to do such a thing did exist in the past and still do exist today. The critical question is whether there are individuals and institutions now courageous enough to stop this mass murder.

John Grauerholz, an associate editor of *21st Century*, has studied AIDS since 1983, and has addressed conferences on this subject around the world.

### References

1. The full text of the letter by Samuel Evans to members of Congress is printed in the *Executive Intelligence Review*, March 17, 1989, p. 40.
2. Testimony before a subcommittee of the House Committee on Appropriations. Department of Defense Appropriations for 1970, Washington, D.C., 1969, cited in Robert Harris and Jeremy Paxman, *A Higher Form of Killing: The Secret Story of Chemical and Biological Warfare* (New York: Hill and Wang, 1982), pp. 264-267, 294.
3. *Bulletin of the World Health Organization*, 47:257 (1972).
4. Theodore A. Strecker and Dr. Robert B. Strecker, M.D., Ph.D., *Bio-Attack Alert*. Los Angeles: The Strecker Group (1216 Wilshire Blvd, Los Angeles, Calif. 90017), 1986. A videotape, *The Strecker Memorandum*, by the same authors, is also available from The Strecker Group.
5. John Seale, "AIDS As a Cross-Species Viral Transfer," p. 15 in this issue of *21st Century*; John Grauerholz, "Did the AIDS Virus Originate in a Soviet Laboratory Accident?" *21st Century*, Sept.-Oct. 1988, p. 12.
6. T.C. Quinn et al., "Serologic and Immunologic Studies in Patients with AIDS in North America and Africa—The Potential Role of Infectious Agents as Cofactors in HIV Infection," *JAMA* 257:2617 (May 15, 1987).
7. Alan Cantwell, *AIDS and the Doctors of Death*. Los Angeles: Aries Rising Press, 1988, chapters 5-6.
8. Litvinov WHO statement of 1985 on AIDS panic emanating from U.S. See *Executive Intelligence Review*, Oct. 25, 1985, pp. 26-35.
9. Bertrand Russell, *The Impact of Science on Society*. New York: Simon and Schuster, 1953, pp. 102-104.
10. ———, *The Prospects of Industrial Civilization*. London: George Allen and Unwin, 1923, p. 273.
11. H.G. Wells, *Anticipations of the Reaction to Mechanical and Scientific Progress Upon Human Life and Thought*. New York: Harper and Brothers, 1902, p. 314.

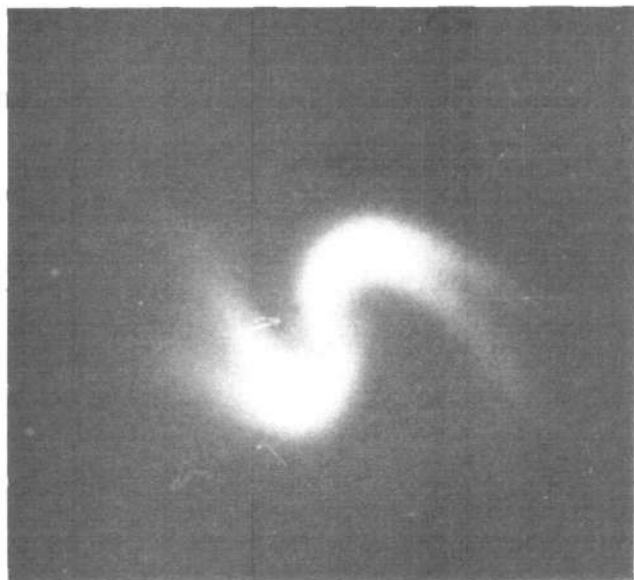

Hale Observatories

## A Way Out of the Quasar Redshift Shambles

by Winston H. Bostick

Since the 1960 discovery of quasars by Sandage and Matthews and the subsequent identification by Maarten Schmidt of their initially puzzling spectral lines as the lines of familiar elements redshifted to 80 or 90 percent of the velocity of light, the astronomical and cosmological community, already hypnotized (almost unanimously) by the Big Bang hypothesis, has believed that these quasars partake of the Hubble expansion and are quasi-stellar objects of *extremely* high power and *extremely* far away.

Prior to 1963, the highest redshifted galaxies known had maximum redshifts of 20 to 40 percent of the velocity of light. In 1968, astronomer Halton Arp published a paper that challenged this "conventional-wisdom" view of the quasar and has since then continued in this almost one-man stand against the astronomical establishment, finally publishing his own book on the subject (Arp 1987; Cherry 1989).

With coherent, overwhelming evidence, Arp shows in his book that quasars are intimately associated in time and space with companion galaxies that have recessional-velocity redshifts (presumably of a Hubble-expan-

sion derivation) that are a small fraction of the observed quasar redshifts. Thus the edifice of interpretation of the quasar, which was erected and worshipped since 1966 by the most prestigious and powerful architects of the astronomical community, now comes tumbling down.

As the entire community of astronomers and cosmologists is seen staggering, coughing and blinking, out of the dust and rubble of this debacle, one asks, where is the messiah who can lead these people in a sounder design and reconstruction of their temple?

In his book, Arp suggests that the electrons in the quasar have a markedly different mass from those of its companion galaxy and that the highly redshifted spectral lines are therefore not due to a Doppler effect but to an electron mass effect. I suggest a less radical explanation.

### The Plasma Universe

The messiah could very well come in the form of an application of knowledge that has been developed from the point of view popularly known as "Hannes Alfvén's plasma universe" (Alfvén 1986; Peratt 1986). However, the concept of the plasma universe is

not the sole domain of Hannes Alfvén; there have been a number of experimentalists and theoreticians in plasma physics who have also made relevant and significant contributions.

The solution to the problem involves, among other things, an understanding of the basic process of galactic evolution. There are three plasma physicists fairly well qualified in the matter of this understanding: Anthony Peratt of Los Alamos National Laboratory, and myself and Vittorio Nardi of the Stevens Institute of Technology in Hoboken, N.J.

Peratt's computer simulations since 1982 of the genesis of barred-spiral galaxies (Peratt 1986) confirm the author's laboratory simulations in 1955 (Bostick 1956a-b, 1957a-c, 1958, 1986; Laurence 1956) at Lawrence Livermore National Laboratory, where animated barred-spiral plasma configurations were observed by Kerr cell photography when two plasma jets were projected at each other across a background magnetic field in the presence of an otherwise stationary, low-pressure background ionized gas.

The picture of galactic genesis triggered and inspired by the Kerr cell



Two blobs of plasma ("plasmoids"), fired at each other in a laboratory, collide to produce the rotating structure at left, bearing some similarity to the barred-spiral galaxy (NGC 175) at right.

photos (page 56) is diagrammed in Figure 2.

The starting point is a universe where a tenuous plasma of fairly constant density is immersed in a uniform magnetic field, Figure 2(a). Fluctuations in mass density produce some initial gravitational forces, which become centers of gravitational contraction and lead to a steady increase in the strength of these centers of contraction in the manner originally described by British physical theorist James Jeans—except that the contraction perpendicular to the magnetic field lines is retarded while the contraction along the field lines continues uninhibited.

The central gravitational force,  $g$ , in conjunction with the compressed magnetic field  $B_z$ , which halts further radial inward movement of the plasma perpendicular to the field,  $B_z$ , is a perfect setup for the growth of Rayleigh-Taylor instability flutes, which grow inward.

If these flutes grow inward in the presence of an otherwise stationary background plasma, the flutes are expected to become jets: The situation is thus analogous to the 1955 laboratory projection of plasma jets (Bostick 1956a-b, 1957a-c, 1958, 1986; Laurence 1956) across a magnetic field, which produced barred-spiral configurations as seen in Figure 1.

#### Laboratory Simulation

Peratt's 1982 "motion pictures" of computer simulation with particle-in-cell, fully electromagnetic, 3-D codes beautifully show similar configurations.

However, the laboratory Kerr cell photos are of higher conceptual fidelity in that the cosmical central gravitational force is simulated in the laboratory by the inertial force that the drag of the background plasma exerts on the jets.

In Peratt's computer simulation, the central gravitational force is simulated by a clever but ersatz artifice, the force between two attracting, parallel currents (parallel to  $B_z$ ). There is assumed

to be a potential due to a double-layer (of unexplained origin), which drives the two parallel currents.

Now, by happy circumstance, this author not only was involved with the Kerr cell photos of 1955 at Lawrence Livermore National Laboratory, but also was intimately involved with the Stevens plasma focus group in studying the role of the Beltrami-like, force-free vortex filaments that carry the current in the plasma focus device. The rupture of these filaments produces the electromagnetic ram action (Bostick 1985, 1986), with the consequent acceleration of deuterons with energies up to 13 MeV in the direction of current flow and of electrons to relativistic energies in the opposite direction.

#### Circulating Cells

Prof. Vittorio Nardi of the Stevens Institute plasma focus research group had discovered that the relativistic electron "beam" produced by the plasma focus was organized into force-free circulating vortex cells or filaments, each one containing large numbers of electrons, and that these circulating cells in turn organized each other into a definite pattern (Nardi et al. 1980; Luce et al. 1978; Bostick 1986, 1987).

It has been observed in a small (10 kJ) plasma focus machine at Stevens that these electron vortex cells in their passage through the background deuterium gas (~3 torr pressure) provide an instrument for collectively accelerating the deuterons to energies of 20 MeV. In the FX-100 electron accelerator operating at 5 MeV at the Air Force Weapons Laboratory in Albuquerque, John Luce collectively accelerated protons to 50 MeV (Luce et al., 1978). William Destler at the University of Maryland has used similar collective acceleration methods to achieve 400 MeV for heavier ions (Destler et al. 1980).

The author and his colleague Nardi have already suggested that the gigantic jets from active galaxies are due to the ion beams being accelerated by the plasma-focus, electromagnetic ram action occurring in galaxies at the sites indicated in Figure 2(e), and that acceleration of ions and collective acceleration at these sites could also account for the cosmic ray primaries (Bostick and Nardi 1985; Bostick 1986).

I now advance the audacious hypothesis that the highly redshifted lines from quasars, as seen by an observer looking at a quasar (a small companion galaxy composed largely of plasma), from either above or below in Figure 2(e), are caused by the ions (which become excited atoms by recombining with electrons) that are collectively accelerated toward the disk (away from the observer) by the fast-moving (relativistic) circulating electron vortex cells (Bostick 1986, 1987) in the hemisphere of the quasar that presents itself to the observer.

This redshifted, de-excitation light of the lines of various elements will be much brighter at the plasma focus than anywhere else in the quasar because it depends upon electron-ion recombination, and the recombination process goes as the square of the plasma density: The plasma focus can produce enormous densification of plasma, by factors as large as  $10^5$ .

Furthermore, it is observed that the electron vortex cells in such electron beams are locked in formation in the  $z$  direction as well as in the  $x$ - $y$  plane, and therefore are all traveling at the same velocity in the  $z$  direction, like all the riders in a motorcycle club as they roll their Harley Davidsons down the highway on a Sunday afternoon. So, one would expect that all the ions collectively accelerated by these electron vortex cells of constant relativistic speed would have the same recession speed and thus the same redshift.

For a redshift corresponding to  $\beta = v/c = 0.8$ ,  $\gamma = (1 - \beta^2)^{-1/2} = (1 - 0.64)^{-1/2} = (0.36)^{-1/2} = 1/0.6 = 1.67$ . For a proton whose rest energy is 931 MeV, this corresponds to a kinetic energy of 624 MeV. There is little doubt that if a small plasma focus device can yield ions of 20 MeV by collective acceleration from its electron beams, a plasma focus produced by a quasar should certainly be able to achieve a collective acceleration for protons of 624 MeV and the corresponding redshift for  $\beta = 0.8$ .

A redshift corresponding to  $\beta = 0.6$  would require protons with an energy of about 233 MeV.

#### Nature Outwits Theoreticians

The skeptics will ask, "How do we know that the barred spiral can coherently act to change gravitational and

*Continued on page 60*

## Redshifts and the Plasma Focus

Can the intrinsic, non-distance-related portion of the redshifts of galaxies and quasars be explained in terms of the high-velocity circulation of the light-emitting hydrogen atoms *within* the structure of the galaxy or quasar?

This suggestion grows out of experimental work with the plasma focus device. The experimental re-

sults suggest a basic model for genesis of the rotations and enhanced magnetic fields of galaxies, quasars, and stars: All observed rotations are the result of gravitational contraction of plasma across a primordial magnetic field. The rotating inner part becomes the armature of a homopolar generator that drives a current pattern through

force-free plasma vortex filaments that act as "wires."

The result is that the current flowing in the oppositely rotating outer portion coherently reinforces the original primordial magnetic field, thereby enabling the equipartition of the gravitational energy into rotational energy and magnetic-field energy.

The high velocity of the hydrogen ions (which become excited hydrogen atoms upon recombination) is

**Figure 2**  
**HYPOTHESIZED STAGES IN THE**  
**FORMATION OF A QUASAR**

*In this hypothesis, the matter in a quasar—like that in a galaxy—is concentrated in a rotating disk, which is seen edge-on in (a), where it is represented by the dotted area. Gravitational contraction of the plasma has already occurred along the magnetic field lines, but not at right-angles to it.*

*The edge-on disk is seen at a later stage in (b). The magnetic field lines have been dragged along as matter—under gravitational force—concentrates in the center of the disk. The field lines have also curved and reconnected with themselves.*

*At the next stage, the disk is seen face-on (c). A few of the magnetic field lines are represented by the small circles—the circled crosses nearer the center are the field lines going into the paper; the circled dots farther out are those coming out. What is new here is the formation of two plasma jets in the plane of the disk that move toward its center. They are plasma densifications, caused by Rayleigh-Taylor (density inversion) instability.*

*The most familiar form of density inversion is the case of cold, dense air occurring above warm, thin air. An instability must develop to allow the cold, dense air to fall to the bottom. In (c), however, the magnetic field plays a role in the phenomenon.  $v_M$  denotes rotational drift of ions due to gravitational force,  $g$ .  $v_m$  denotes rotational drift of electrons due to gravitational force.*

*In (d) the plasma jets have twisted up. The bridge between the heads of the jets is stretched tight by their electromagnetic interaction. The two jets have forward motion and cause the bridge to rotate through the magnetic field, generating electrical current. While the bridge and the plasma jets have the same morphology as the bar and arms of a barred spiral galaxy, these features cannot be seen in a quasar, which is presumed to be made up entirely of plasma, without star formation.*

*Formation of two plasma foci at right-angles to the disk is seen in the edge-on view in (e). Current flows from the tips of the bridge to its center, and thence away from the*

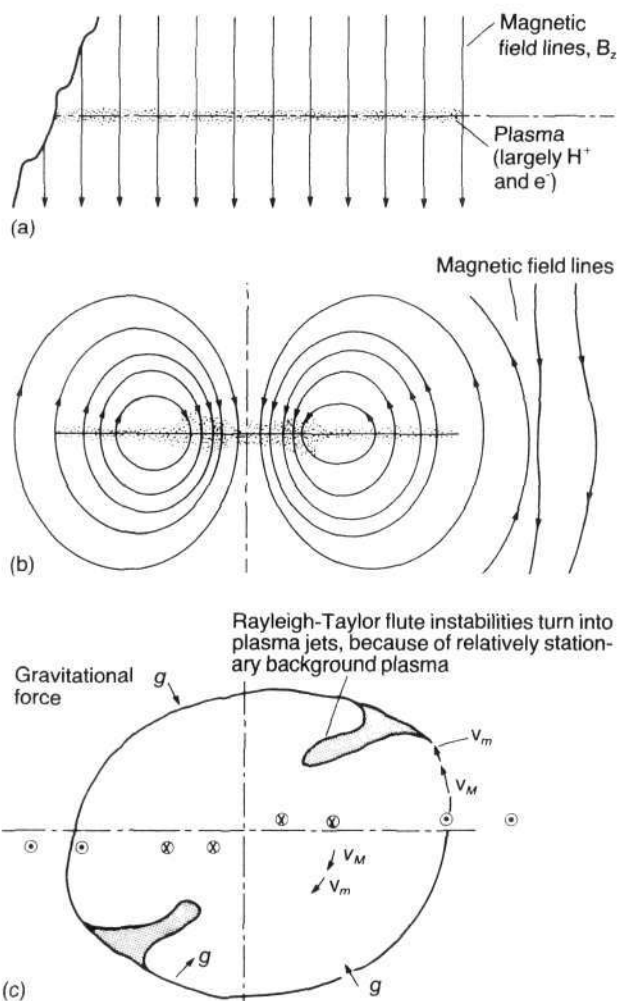

*disk in opposite directions. Ions move oppositely: they are accelerated toward the disk in these plasma foci.*

*The column of current-carrying plasma on each side rises to the halo (in the terminology of galaxies), makes several magnetic-field enforcing loops (f), descends to the disk, and returns to the tips of the bridge through the plasma jets, always flowing in force-free filaments.*

explained by the electromagnetic ram effect that occurs in the plasma focus.

The mass velocity,  $v$ , is approximately equal to  $v_M$  since  $v_M$  is so much larger than  $v_m$  and  $M$  is much larger than  $m$ . The electromagnetic force along the bar is  $E = v \times B$ .

The electromagnetic ram action of the two plasma foci accelerates hydrogen ions toward the disk in each hemisphere. If the observer is looking along the axis (that is, if the

galaxy is seen face-on) the hydrogen atoms formed by ions recombined with electrons will always show a redshift. Incidentally, the gigantic jets in active galaxies are caused by this electromagnetic ram action.

In the case of the quasar, suppose that within the magnetic field of a galaxy there is a local condensation (smaller than that of a galaxy but larger than that of a star) that mimics the galaxy's construction

and forms the same system of two plasma foci, each one giving a redshift to the observer who happens to be looking at that particular face of the quasar. The energies (20-50 MeV) of the deuterium ions collectively accelerated by the vortex cells of the relativistic electron beams generated in the plasma focus in the laboratory suggest that the plasma focus of a quasar can easily attain the redshift velocities observed in quasars.

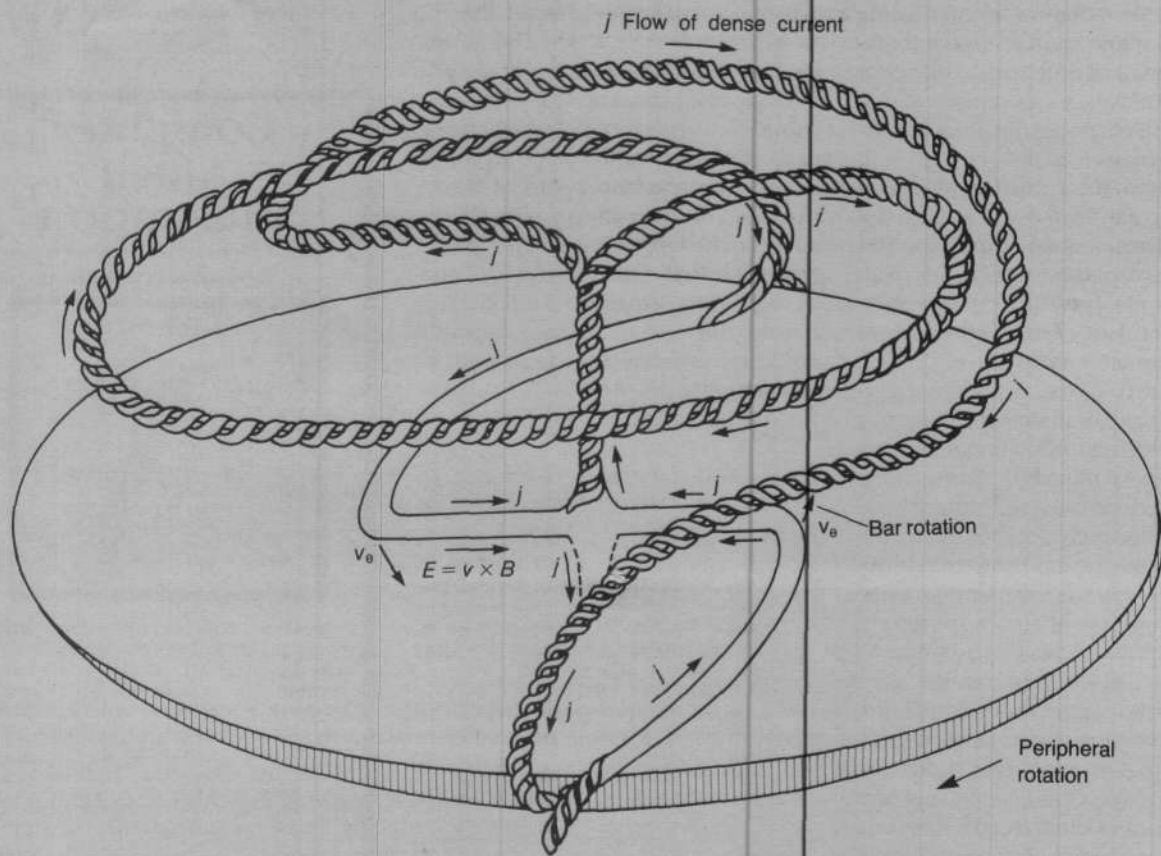
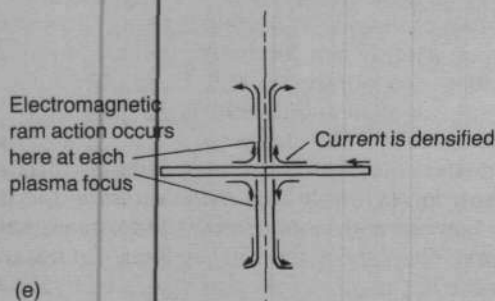
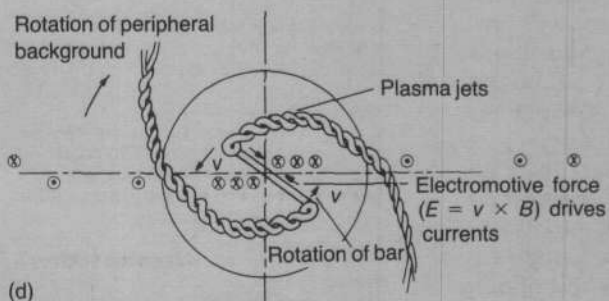

Continued from page 57

rotational energy to magnetic energy to sustain the operation of the electromagnetic ram?" The answer is that nature will always strive for equipartition of energy in order to reduce the free energy, and she does so beautifully in producing pairs of minimum-free-energy, force-free vortex filaments to carry the current in the plasma focus.

No theoretician predicted this event. If nature can outwit the theoreticians so easily for years in the plasma focus device, what is to prevent her from doing so in the galaxy?

This author has described this possible explanation of the quasar redshift to Arp, who graciously and promptly replied, stating two objections. The first objection is that all components of the galaxy across its entire face show the same redshift. How then can the internal circulation of ions in a quasar show essentially one and only one redshift?

My reply is that the quasar consists almost entirely of magnetized plasma whose visible radiation, primarily line spectra resulting from the recombination of ions and electrons, is intense only in the plasma focus regions where the ion (and electron) densities can be increased by factors of  $10^3$  to  $10^5$ . And the recombination rate increases as the square of the ion density! Thus the visible radiation of the quasar appears on the telescope photos as a small spot (with a single redshift) compared to the larger and more complex structure of the companion galaxy.

The ions that are directly accelerated by the gap of the electromagnetic ram will give recombination line spectra showing a blueshift. These ions, which have lower energies than those that are collectively accelerated by the relativistic electrons, have a continuous energy spectrum rather than a discrete energy spectrum; therefore, their blueshifted lines will be smeared rather than a discrete spectrum.

Arp's second objection was that redshifts from atoms with  $\Delta\lambda/\lambda$  corresponding to Doppler effects for the near relativistic velocities of 80 percent to 90 percent of the speed of light represent recessional energies of hundreds of MeV. Arp implies that the plasma focus effect could never achieve these energies. My answer is

that the collective acceleration of deuterons in the Stevens small 5-10 kJ plasma focus machine produces 20 MeV deuterons. It is my belief that the same process in the active galaxies produces the acceleration of the cosmic ray primaries with energies up to  $10^{20}$  eV =  $10^{11}$  GeV. An able-bodied quasar should be able to reach a value range of 0.1-10 GeV.

This treatment of galactic genesis now comes forward with additional, nontrivial, succulent dividends: The constant increase of magnetic energy of each galaxy by the transformation of gravitational energy to rotational energy to magnetic energy will produce, by mutual magnetic induction, a repulsive force between neighboring galaxies (Bostick 1957, 1958, 1986, 1988; Laurence 1956). This repulsive force is considerably greater than the attractive gravitational force between those galaxies. Therefore, the Hubble expansion of the universe can be explained by the repulsive effect of mutual magnetic induction without recourse to the hypothesis of the Big Bang (Bostick 1979, 1988). The author advanced this thesis as early as 1956 (Bostick 1958; Laurence 1956).

One can show that the ions accelerated collectively by the electron vortex cells of the electron beam of Figure 2(e) will always recede from the observer in the hemisphere of the galaxy presented to the observer by the quasar to produce a redshift. The only way to turn this redshift into a blueshift would be to make the quasar out of antimatter.

#### References

- Hannes Alfvén, 1986. "Model of the Plasma Universe," *IEEE Trans. on Plasma Science*, vol. PS-14 No. 6, 629 (Dec. 1986).
- Halton Arp, 1987. *Quasars, Redshifts and Controversies* (Interstellar Media, Berkeley, Calif.).
- W.H. Bostick, 1956a. "Experimental Study of Plasmods," in *Electromagnetic Phenomena in Cosmical Physics*, IAU Symposium No. 6, Stockholm, 1956 (Cambridge University Press), 87.
- , 1956b. *Physical Review* 104:292.
- , 1957a. *Physical Review* 106:404.
- , 1957b. "Plasmods," *Scientific American*, Oct. 1957, 81.
- , 1957c. "Simulation of Astrophysical Processes in the Laboratory," *Nature*, 197:214 (Jan. 26, 1957).
- , 1958. *Reviews of Modern Physics*, 30:1090.
- , 1986. *IEEE Trans. on Plasma Science*, Vol. PS-14, 703.
- , 1987. *Fusion Technology*, 12:92 (July 1987).

———, 1988. "The Hubble Expansion as Ascribed to Mutual Magnetic Induction Between Neighboring Galaxies," *Lasers and Particle Beams*, 6:405.

W.H. Bostick and V. Nardi, 1985. "Electromagnetic Ram as a Model for Production of Electron and Ion Beams in the Plasma Focus and the Cosmic Rays and Gigantic Jets in the Cosmos," in *Proc. 19th International Cosmic Ray Conference*, La Jolla, Calif., Aug. 1985, S.C. Jones, ed. (Springfield, Va.: NASA Sci. and Tech. Int. Branch), 183.

David Cherry, 1989. "Where Do Galaxies Come From?—Redshifts and the Spirit of Scientific Inquiry," *21st Century* 2:3 (May-June 1989), p. 34.

William Destler, L. E. Floyd, and M. Reiser, 1980. "Collective Acceleration of Heavy Ions," *Phys. Rev. Letters* 44:70.

J.S. Luce, W.H. Bostick, and V. Nardi, 1978. "LLL Experiments in Collective Field Accelerations, II," in *Proc. 2nd Int'l Conference on Energy Storage, Compression, and Switching* (New York: Plenum), 457.

W.L. Laurence, 1956. "Physicist Creates Universe in a Test Tube," *New York Times*, Dec. 12, 1956, 1.

V. Nardi, 1986. "Production of Ion Clusters in Megagauss Fields," presented at the *Fourth International Conference on Megagauss Magnetic Field Generation and Related Topics* (Santa Fe, N.M., July 1986), paper 33.

V. Nardi, W.H. Bostick, J. Feugeas, and W. Prior, 1980. "Internal Structure of Electron Beams," *Physical Review*, 22A:2211.

V. Nardi and I. Brzosko, 1988. *IEEE Trans. on Plasma Science* 16:368, p. 374.

A. Peratt, 1986. "Evolution of the Plasma Universe," *IEEE Trans. on Plasma Science*, vol. PS-14 No. 6, Part I, 639; Part II, 763.

## Computer Aided Illustration

For times when computer graphics just aren't enough.

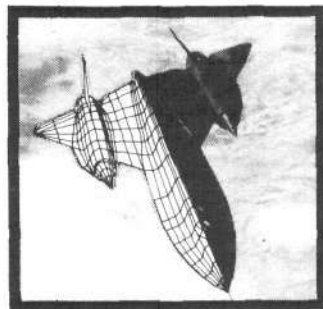

Supply us with anything from engineering plans to rough sketches. We'll use the latest 3-D modeling software combined with in-depth technical and artistic experience to produce accurate, realistic renderings of your ideas. Your choice of watercolor or oil. We can also work from your own CAD images.

For more information and for estimates, call or write:

**Computer Aided Illustration**  
25 Richard Drive  
Flanders, NJ 07836  
(201) 927-9120

## Do Embryos Need Gravity?

by David Cherry

When the *Discovery* flew in March 1989, a student experiment of fertilized chicken eggs went with it. The experiment returned to provide its author and world science with a provocative finding of great importance: The very early embryo seems to require the presence of a gravitational field in some way.

John Vellinger, the student behind the experiment, first competed in the Space Shuttle Student Involvement Program (SSIP) of NASA as a freshman in high school. He had a proposal to send pregnant rats into space to see how the embryo would be affected by weightlessness. Although his project was not chosen, he entered again the next year.

It wasn't until he thought of sending up chicken eggs, in his junior year submission, that his project became a national winner. Eggs make a much tidier, simpler package to send aloft than pregnant rats. It is also much easier to study a chicken egg than a tiny rat embryo attached to the wall of its mother's uterus. Nevertheless, the eggs had to be protected from breaking during liftoff, and their temperature and humidity had to be kept constant.

The final experiment included 64 eggs. Thirty-two were controls that remained on the ground in an identical incubator. The ground incubator was subjected to vibrations simulating launch at the same time that the other incubator was experiencing liftoff. It was not possible to submit the control group of eggs to equivalent gravitational forces simultaneous with liftoff, although centrifuge tests were performed earlier.

Each group of thirty-two eggs was divided into four groups of eight. Two of these groups of eight were two days old at the time of liftoff, and the other two were nine days old. One group of each age cohort was opened when the Shuttle landed, while the other group

of each age cohort was encouraged to hatch.

The result was very clearcut—much more clearcut than scientists can usually hope for. When eight eggs that were two days old at launch were opened upon landing, all eight embryos were dead. The stage of development at the time of death proved that all but one or two had survived liftoff. They had survived to three or four days. When eight of the eggs of the same age that had remained on the Earth were opened, all were alive.

The older groups of eggs—both those that flew and their Earth control group—when opened, were all alive.

The eggs that were encouraged to hatch showed exactly the same pattern. Not one of the eggs in this group that had gone into space at two days old hatched. Eight ground controls of the same age did hatch. And the older groups of eggs—both those that flew and their Earthbound counterparts—all hatched.

### A Gravity Trigger?

This evidence encourages us to think that Earth's gravity plays an essential role in triggering or ordering one or more processes in the development of the chicken embryo, up to some point between two and nine days of development, but is not essential to the survival of the embryo thereafter. The evidence also leads us to ask whether gravity plays the same essential role for the human embryo.

Just *how* gravity influences the differentiation of the embryo is an important question for the scientists now carefully studying Vellinger's eggs. The mother hen frequently turns her eggs, and this prevents the yolk from adhering to one side of the shell. Why doesn't this disrupt the role of gravity? Is it possible that there is a process or processes of very short duration that depend upon the embryo not being disturbed in relation to the gravitational field? The turning process would



*Journal and Courier, Lafayette, Ind.*  
John Vellinger holds a mockup of his proposed experiment in this 1983 photo, taken when he was in high school.

then be fatal to very few embryos. How strong does the gravitational field have to be? Is the gravity of the Moon or Mars sufficient?

Vellinger's eggs—and the chicks that emerged from some of them—are also being studied by scientists interested in three other subjects. One of these is the problem of astronauts' bone loss. In chicks, normal bone mineralization takes place on day 10, but what will happen in space?

The second is the problem of disorientation and seasickness in space that seems to be controlled by a crystal-like structure, the otolith, in the inner ear. What can we learn from studying the otoliths of the chicks?

The third problem is of special interest to Vellinger's corporate sponsor, Kentucky Fried Chicken: Can chickens be bred as a food source in space? What kind of a chicken will grow from an embryo nurtured in space? Will it grow or reproduce faster?

Vellinger, who attended Jefferson High School in Lafayette, Ind., is now a senior in mechanical engineering at Purdue University. After graduation, Vellinger says he will be looking for a job in the aerospace industry: "I want to design things for the Space Station, for the Shuttle, for the next step in space. That's what I am excited about."

### For More Information

Students in grades 6 through 12 who wish to participate in the SSIP, now called the Space Science Student Involvement Program and cosponsored by NASA and the National Science Teachers Association, should write to: NSTA-SST, 5112 Berwyn Road, 3rd Floor, College Park, Md. 20740.

## THE CASE FOR MARS

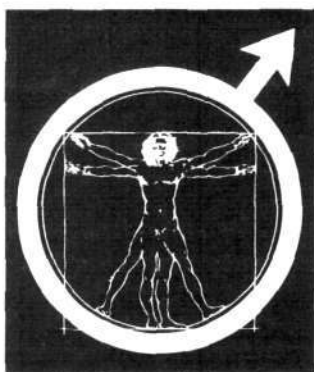

AN AMERICAN ASTRONAUTICAL SOCIETY PUBLICATION

**The Case for Mars III**, This three-part set, based on a conference held July 18-22, 1987, Boulder, Colorado, will be published late 1988. Prepublication price for Part I (general) is \$20 (soft cover), Parts II & III (technical) \$60 (soft cover, both parts). No discount on these. Write for more information.

**The Case for Mars II**, Ed., Christopher P. McKay, 1985, Second Printing 1988, 730p, Hard Cover \$60; Soft Cover \$40 (\$4 postage & handling)

This book provides a blueprint for manned missions to Mars and a continued presence on the planet's surface, including what technology is required, and what kinds of precursor missions and experiments are required for this undertaking. The material is based on a conference held July 10-14, 1984, Boulder, Colorado.

**The Case for Mars I**, Ed., Penelope J. Boston, 1984, Second Printing 1987, 348p, Hard Cover \$45, Soft Cover \$25

Included in this volume are mission strategy, spacecraft design, life support, surface activities and materials processing, social and political aspects.

Also numerous books on space published for the American Astronautical Society or distributed for other publishers are available from Univelt Inc. Write for a free catalog.

Among available books are:

**Space and Society - Challenges and Choices**, Volume 59, Science and Technology Series, Eds., Paul Anaëjinou, Nathan C. Goldman, Philip J. Meeks, 1984, 442p, Hard Cover \$55; Soft Cover \$35.

Subjects included are American government and space, political economics and space, foreign space programs, space applications, and the future. Index.

**The Human Quest in Space**, Volume 65, Science and Technology Series, Eds. Gerald L. Burdett, Gerald A. Soffen, 1987, 312p, Hard Cover \$55; Soft Cover \$45.

As the title suggests, the human role in the space program is stressed. Emphasis is placed on medical problems in long-duration space flight and the development of closed ecological systems including the pioneer work being conducted on *Biosphere II* in Arizona.

(Readers of *21st Century Science and Technology* may take a 25% discount off list prices)

Order from Univelt, Inc., P.O. Box 28130, San Diego, CA 92128

## BOOKS

# The Deafness of Today's Recording Industry

### The Wood Effect

R. C. Johnsen

Boston: *Modern Audio Assn.*, 1988

(23 Stillings Street, Boston, Mass. 02210)

Paperback, 98 pages, \$7.95

R. C. Johnsen has fired a barrage at the audio-recording industry. A combination of moral outrage, hard work, and intellectual acumen, mixed with wit, humor, and even street-theater antics, makes this 98-page book a rare and refreshing exposé, guaranteed to miss the audio industry's puff sheets.

Johnsen has seized upon a simple truth: Music and speech are living processes. The authentic representation of such living processes for larger audiences involves more than adding up scalar, quantized units of vibrating dead things. When Helmholtzians sell the latter as the genuine article, the listener should beware.

The particular problem referred to as the Wood Effect was first detected by Charles Wood in 1957, at the Defense Research Laboratory at the University of Texas. Wood designed a sound characterized by a sinusoidal wave with a flattened top and found that the reversal of compression and rarefaction patterns in the reproduced sound would change its timbre.

In recording an actual musical performance, therefore, it matters that the physical sequence of compression and rarefaction is preserved in the recording as the actual physical event occurred. If the polarity is reversed, or if the recording is simply recorded out of phase, a key aspect of the live performance is blunted. Most of the recording industry ignores this question of polarity.

The author documents his findings with example after example, as he takes the reader on a tour of the recording industry, its history, its productions, and the extant literature on the subject of 'absolute polarity.' How does he conduct his tour? Not unob-

trusively. He tracks his subject "as a hunter knows his quarry, by reading the spoor. . . . The hunter reads the mind of his prey from the spoor, to discover which species have been present and how recently, and where each can be found next. If he then places himself on the flank, he has tracked well."

Granted, only an audiophile will appreciate some of the described infighting in the audio industry. However, there are precious jewels to be found here too. Where else does one find Thomas Edison's assertion, "Music has done more to elevate the spirit of man than anything else since the birth of Christ"?

### Helmholtzian Deafness

The industry is properly indicted for its obsession with developing recording technologies that fit in with a "planned obsolescence" marketing strategy. Currently, the compact disc technology is to be served up in three stages, with increasing sampling rates, allowing for new waves of purchases of audio products a few years apart. The actual logjam in present audio reproduction systems—the relatively poor quality of the home delivery systems—remains as a result.

However, this too-typical industry problem is dwarfed by the ideological deafness maintained by the Helmholtzians. Since their auditory theory does not account for absolute polarity, it does not exist. And if someone hears it, they must be a kook.

Johnsen claims, "... Helmholtz was wrong to deny monaural phase audi-

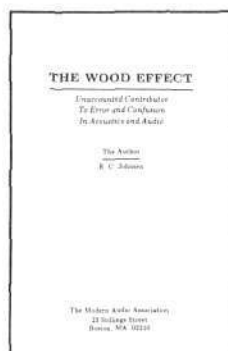

bility. So immensely wrong, in fact, that a whole new auditory theory is needed, based on the neglected work of his academic adversary, Bernhard Riemann." He adds parenthetically, "Helmholtz was driven by vengeful animus, and by a mistaken belief that the relationship between the human mind and nature is statistical in character."

This affair of the acoustical theory of the ear should remind readers of the famous, documented case of Helmholtz's inability to deal with Riemann's 1859 work on shock waves, and the pathetic insistence of the Helmholtzians on the impossibility of the existence of such waves.

#### A Remedy

The author may rail against the audio industry, but he does propose a remedy: "Develop a 'cutting-edge' phonograph made of the finest parts and designs, far beyond today's mere 'state of the art.' That system would then be replicated and demonstrated before the public, forcing manufacturers to cringe or compete." Excellent!

Further, he advises, that until a "comprehensive sonic theory" is developed, "aesthetics in music reproduction must be thoroughly dequantified." A sound methodological suggestion. Instead of quantification, Johnsen maintains, for the time being we should simply ask, "Does this device sound right, or not?" To any true instrument builder, that is the question."

All well and good. However, the questions that this book brings forward are too good to remain locked within the domain of technicians and audiophiles. And, to the extent that the author attempts to ask these questions within that domain, the book's discussion is skewed. For example, how does the true instrument builder know what sounds right? Was there a "comprehensive sonic theory" preceding Stradivari's work? How does a society grow deaf? Is this simply a conspiracy of short-sighted, money-grubbing audio marketeers, preying upon an innocent public?

Johnsen may well blame the audio industry for its role in subverting the listening standards of the general population. He certainly has fun in providing suitable leads in his early chapter—outlining the doings of Morgan and Rockefeller in cornering the work

of Edison, et al. However, sooner or later, the population needs to be asked whether it deserves what it is getting.

#### The Survival of Beauty

The standards of sound reproduction systems will rise or fall depending on the standards of live performance. A society that makes a habit of speaking truthfully, and singing beautifully, will hear inauthentic reproductions as 'tinny,' and so on. However, if a society grows increasingly deaf to the richness of an actual public performance of Beethoven's late quartets, or for that matter, increasingly deaf to the rich interconnections of Shakespeare's English, or even to the richness of possibilities of human action reflected in a public discussion of the Federalist Papers, then no revised audio industry standards will reverse the damage. Fundamental questions on the survival of beauty in culture will not be answered simply in the battle over the preservation of earlier recordings.

Johnsen does not totally miss this problem. He quotes, in passing, David Stodolsky's statement that the "fact that there is less and less listening to 'live' music . . . could result in rejection of phase parameters by the ear-

brain systems as 'useless information.' Many of us could have become *phase deaf*" (*Transactions on Audio and Electroacoustics*, 1970).

Later, he concludes quite forcefully that "the cult of novelty cannot breed true culture. Only the adoption and dissemination of true sound standards, including accessible music reproduction systems capable of cutting-edge performance, combined with extensive efforts to isolate and draw the best from the past, can attain the glory of culture. The rest is folly."

If by the "adoption and dissemination of true sound standards" the author means real, live recitation of poetry, or vibrant, passionate, public discourse over important ideas, or the lased and round sound of bel canto singing, then he has situated his fight for "music reproduction systems" exactly where it should be. To that degree, Johnsen does musicians, engineers, and citizens a much-needed favor.

Johnsen takes the reader on his own, very personalized tour. This may make for an uneven ride, but the sights on the tour generally live up to the trust that the reader must put in the tour-guide.

—David Shavin

## Dr. Leakey's Inhuman Heroine

### Gorillas in the Mist

Warner Brothers  
Universal Pictures, 1988  
Available in videocassette

*Gorillas in the Mist* deserves scrutiny whether or not it is a box office success. In a world where animal activists are bombing science laboratories and where many countries, as well as the state of Massachusetts, are considering laws that protect farm animals from the predation of farmers, the insanity of the film's heroine, Diane Fossey, cannot be taken lightly.

More important, beyond Fossey herself are the people, notably Dr. Louis Leakey, who created her.

Fossey's claims as a heroine are not built around any scientific achievement in the study of gorillas in the wild, but rather in the violent and anti-



human extremes to which she would go to protect the great apes—and in the fact that she was murdered by unknown assailants.

Fossey's hatred of African tribesmen of the Congo and Rwanda who make their living capturing gorillas ultimately became an obsession. She resorts to magic ritual, torture, violence, and, in real life, perhaps homicide. Her closest relations in the film (and in fact) are with the gorillas: Her outstanding "love" in life is the silver-back male gorilla troop leader Digit. Fossey, in the end, is buried by his side.

#### Human Disgrace

How does such a woman—vile in behavior, inhuman in action, and perhaps even a disgrace to the rather more gentle and understandable creature she claims to protect—become a heroine?

Fossey was chosen by British Empire operative Louis Leakey as part of a female crew of amateurs to study man's "closest relatives" the chimpanzee, the gorilla, and the orangutan.

The assumption stated in the film is that to know man one must study his

ape predecessors and relatives. That which makes man unique is left out.

Although Leakey is an expert on stone tool-making, he ascribes the beginning of humanity to magic. He, like others of his Darwinian bent, sought to prove that man could never be better than his presumed animal "heritage."

Leakey's rejection of the rational is also seen in his reason for choosing amateur women to sponsor. These women, he argued, could get "closer" to the animals. Such "closeness," of course, led to the highly objectionable practice of altering and anthropomorphizing the animal behavior.

Fossey herself, unstable and obsessive, was perhaps as much a victim of this ghoulish exercise by Leakey as the gorillas.

But perhaps the greatest irony in these animal studies was the shock of another Leakey protégé, Jane Goodall, in observing the chimpanzees of the Gombe river preserve. After some 18 years of gushing over these chimps, Goodall was appalled to witness cannibalism and murder, even warlike raids

between troops.

The movie, flawed in execution, cold in its treatment of Africans, fails in its efforts at glorification. Sigourney Weaver, the star, bears some resemblance to Fossey but suffers from a lack of human spark. We can be sure, however, that there will be more such efforts by those who not only deny the divinity of man, but insist on proving it by being worse than the beast.

—Judah Philip Rubinstein

## 21<sup>st</sup> CENTURY SCIENCE & TECHNOLOGY



### on Microfilm?

Are you interested in having  
21<sup>st</sup> CENTURY on microfilm?

Please let us know.

Write to:  
21<sup>st</sup> CENTURY  
PO Box 65473, Dept. M  
Washington, DC 20035

## BEN FRANKLIN Booksellers & Record Shop

#### Featuring:

- Recreational Problems in Geometric Dissections and How to Solve Them** by Harry Lindgren, Dover, \$4.75.
- Mont Saint-Michel and Chartres** by Henry Adams, Princeton U. Press, paper \$9.95; hardcover \$44.50.
- Gothic Architecture and Scholasticism** by Erwin Panofsky, New American Library, \$6.95.
- Drawings in the Pierpont Morgan Library** by Felice Stampfle, Dover, \$8.95.
- Space Station—A Personal Journey** by Hans Mark, Duke U. Press, \$24.95.
- Architectural and Perspective Designs** by Giuseppe Galli Bibiena, Dover, \$8.50.
- The Life of Brunelleschi** by Antonio Manetti, Penn State U. Press, \$17.95.
- The Ten Books on Architecture** by Vitruvius, trans. Morris H. Morgan, Dover, \$7.95.
- Benengeli—Revista Cultural en Español.** En la edición del segundo trimestre se publica un artículo sobre el domo de Brunelleschi. Puede adquirir su suscripción anual por 20 dólares.

#### Books for Young People

- The Amoeba** by Sean Morrison, Coward, McCann, \$3.95.
- Cells—Units of Life** by Barbara Tufty, G.P. Putnam's Sons, \$3.50.
- Marco Polo** by Gian Paolo Ceserani, G.P. Putnam's Sons, \$11.95.

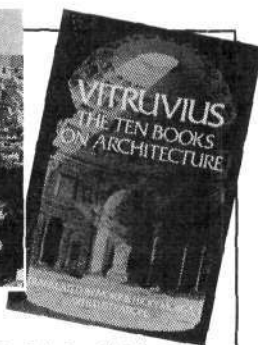

- Venice—Birth of a City** by Piero Ventura, G.P. Putnam's Sons, \$13.95.
- Our Changing World—A Revolving Picture Book** by Ingrid Selberg, Philomel Books, \$11.95.

Ben Franklin  
Booksellers & Record Shop  
27 South King Street  
Leesburg, Virginia 22075  
(703) 777-3661

Call or write for a free catalogue.

Name \_\_\_\_\_

Address \_\_\_\_\_

City \_\_\_\_\_

State \_\_\_\_\_ Zip \_\_\_\_\_

Home phone \_\_\_\_\_

Business phone \_\_\_\_\_

Type of credit card (circle one):

Master Card    Choice    Visa

Credit card # \_\_\_\_\_

Exp. date \_\_\_\_\_

For shipping add \$1.50 for first book  
and \$.50 for each additional book.

Total book price    \$ \_\_\_\_\_

Plus shipping    \$ \_\_\_\_\_

Va. Residents add 4.5%  
sales tax    \_\_\_\_\_

Total Enclosed    \$ \_\_\_\_\_



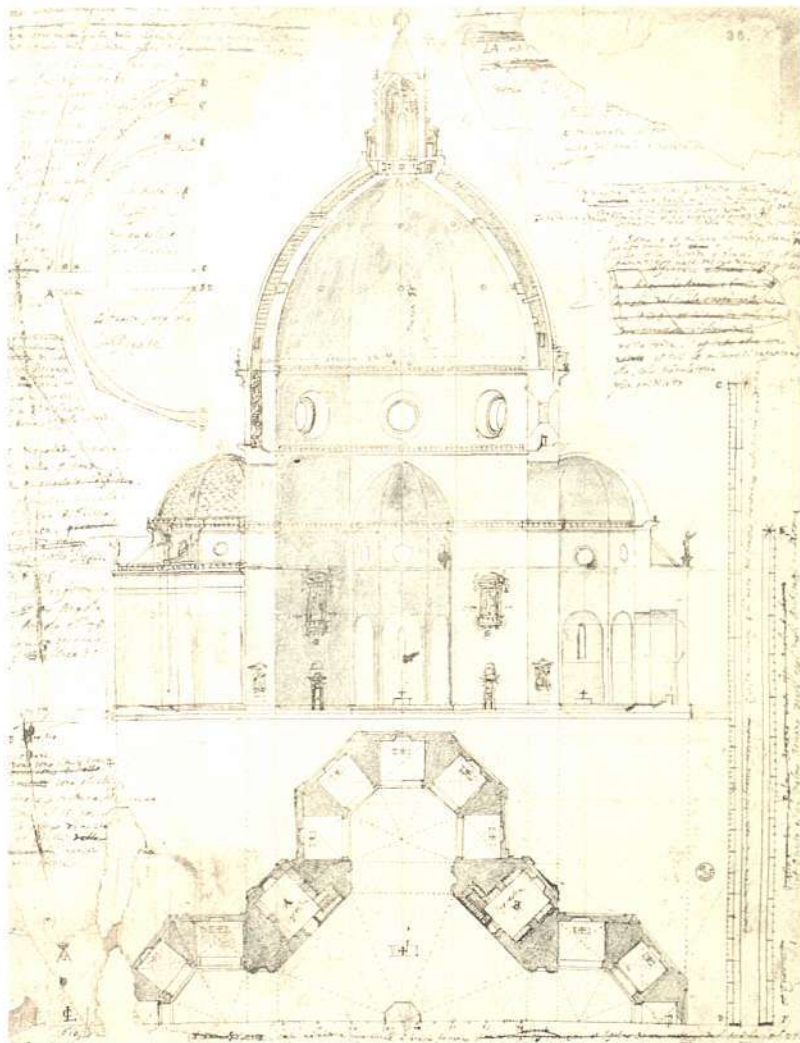

An 18th century drawing of the 42-meter-diameter dome in cross section above the octagonal ground plan; half of the ground plan is shown separately below. Brunelleschi's major achievement was to "capture" this huge space under the dome without using a wooden framework to support the masonry construction.



University of Utah

Stanley Pons (left) and Martin Fleischmann (right) with a graduate student at the University of Utah laboratory where they carried out their "cold fusion" experiments.

## In This Issue

### THE DOME: A GREAT PROJECT OF THE RENAISSANCE

Filippo Brunelleschi's magnificent dome for the Florence Cathedral, Santa Maria del Fiore, remains today as the greatest symbol of Renaissance science. The cover story by Nora Hamerman and Claudio Rossi describes the science of the dome as well as the political context in which it was conceived and developed. Then, as today, there were the doubters of progress. Brunelleschi replied to one of those who attacked his project as impossible: "When hope is given to us by Heaven . . . we rise above corruptible matter and gain the strength of clearest sight. . . . Only the artist, not the fool, discovers that which nature hides."

### THE PROMISE OF FUSION

For four decades, scientists with the dream of creating a cheap, clean, and virtually unlimited source of energy to power the world have worked to bring fusion, the energy process of the Sun and stars, down to Earth. Both main lines of research, inertial and magnetic confinement, are now at the engineering stage. In March, two electrochemists stunned the world when they announced that they had achieved fusion at room temperature. As the Fusion Report makes clear, whether or not this is fusion, the announcement unleashed some welcome scientific optimism: the idea that man, as he has in the past, can create new resources for a developing world.

### OZONE DEPLETION IS A SCIENTIFIC FRAUD

One of the biggest propaganda feats of the 1980s is the environmentalist and media campaign that made people so afraid of an ozone hole in Antarctica that they are willing to suffer cuts in their living standard in order to make the hole smaller. Rogelio Maduro reveals the scientific truth: The ozone hole was discovered back in 1956 by scientist Gordon Dobson, long before the alleged hole-makers, CFCs, were in widespread use. Further, volcanoes and other "natural" phenomena spew far more chlorine and fluorine into the atmosphere than any man-made chemicals.



Bill Rose/Michigan Technological University

The Antarctica volcano Erebus, which alone releases 100-200 tons of chlorine into the atmosphere daily.