

# FUSION

MAGAZINE OF THE FUSION ENERGY FOUNDATION

November 1980

\$2.00 / \$2.25  
in Canada

McCormack  
Fusion Bill  
Passes House 365 to 7

FILE  
COPY

## Science Versus Scarcity

*High Technology  
Agriculture  
Can Feed the World*



72246 00314



# FUSION

MAGAZINE OF THE FUSION ENERGY FOUNDATION

Vol. 4, No. 1  
November 1980

ISSN 0148-0537  
USPS 437-370

## EDITORIAL STAFF

### Editor-in-Chief

Dr. Morris Levitt

### Associate Editor

Dr. Steven Bardwell

### Managing Editor

Marjorie Mazel Hecht

### Art Director

Christopher Sloan

### Fusion Technology Editor

Charles B. Stevens

### Washington News Editor

Marsha Freeman

### Biology News Editor

Dr. Richard Pollak

### Energy News Editor

Lydia Dittler Schulman

### Book Reviews Editor

Dr. John Schoonover

### Production Editor

Catherine Caffrey

### Editorial Assistant

Vin Berg

### Photo Editor

Carlos de Hoyos

### Graphic Assistants

Jerry Steering

Gary Genazzio

### Business and Advertising Manager

Paul Gallagher

### Circulation and Subscription Manager

Maria Spida

FUSION is published monthly by the Fusion Energy Foundation, Suite 2404, 888 Seventh Ave., New York, N.Y. 10019, Tel. (212) 265-3749. Dedicated to providing accurate and comprehensive information on advanced energy technologies and policies, FUSION is committed to restoring American scientific and technological leadership. FUSION coverage of the frontiers of science focuses on the self-developing qualities of the physical universe in such areas as plasma physics—the basis for fusion power—as well as biology and microphysics, and includes groundbreaking studies of the historical development of science and technology.

The views of the FEF are stated in the editorials. Opinions expressed in articles are not necessarily those of the FEF directors or advisory board.

Subscriptions by mail are \$20 for 12 issues or \$38 for 24 issues in the USA; \$25 for 12 issues in Canada. Airmail subscriptions to other countries are \$40 for 12 issues.

Address all correspondence to FUSION, Fusion Energy Foundation, Suite 2404, 888 Seventh Ave., New York, N.Y. 10019.

Second class postage is paid at New York, N.Y. and at additional mailing offices.

## Advertising Representatives

FUSION's national advertising representative is Patricia Van Thof, Fusion, 888 Seventh Ave., Suite 2404, N.Y.C. 10019, (212) 265-3749; East Coast advertising representative is Warren Smith and Associates, 38 Hull Rd., Box 754, Bernardsville, N.J. 07924, (201) 221-0184; European advertising representative is Karl-Heinz Holz, Pf. 3329, 62 Wiesbaden, West Germany, Telephone (06121)440277.

Copyright © September 1980

Fusion Energy Foundation

Printed in the USA

All Rights Reserved

## Special Report:

### Science Versus Scarcity High Technology to Feed a Growing World

#### Agriculture and Science

- 30 The Thermodynamics of Agriculture: How to Feed the Whole World  
*Calvin Larson*
- 44 The Frontiers of Agricultural Science: Making Shock Waves in Productivity  
*Dr. Richard Pollak*
- 52 The Great Pesticide Hoax
- 57 Doing Something About the Weather: The Role of Plasma Physics in Climatology  
*Dr. Steven Bardwell*  
How Weather Systems Work  
*Lyndon H. LaRouche, Jr.*

#### Agriculture in Crisis

- 61 Drought, U.S. Economic Policy Menace Farm Sector  
*Susan Cohen*
- 64 Millions May Die in African Famine  
*Vin Berg*
- 66 We Need a National Water Plan Now

#### Solving the Problem

- 70 Bringing U.S. Productivity to Mexico: A Firsthand Report  
*Cecilia Soto-Estévez*
- 76 Parity: The Key to U.S. Agricultural Economics  
*Lyndon H. LaRouche, Jr.*

## Features

- 22 **Hacer: A Grand Design for Fusion Power in This Century**  
*Dr. Walter Seifritz*

## News

- 8 **EXTRA**  
House Passes Historic \$20 Billion Fusion Bill
- 11 **FUSION UPDATE**
- 13 **WASHINGTON**
- 17 **NATIONAL**
- 19 **INTERNATIONAL**
- 82 **CONFERENCES**  
First Global Conference on the Future:  
World Futurists Turn Back the Clock

## Departments

- 2 **EDITORIAL**
- 3 **LETTERS**
- 4 **THE LIGHTNING ROD**
- 6 **VIEWPOINT**
- 21 **RESEARCH**
- 87 **THE BLUE PAGES**

## Editorial



## Universalizing Scientific Agriculture

We have said many times that what's behind the slowdown of nuclear development is a more general Malthusian zero-growth philosophy that now controls Carter administration policy and intends to determine policy in the future as well. Exactly the same deadly problem faces another industry that has been a *marvel of American technology*—agriculture.

Once again, as we document in this special issue of *Fusion*, an industry with proven and vitally needed capacities is being strangled by antigrowth philosophy and political policies, along with a barrage of environmentalist hoaxes ranging from water use to pesticides.

As we show, the fight to save and expand U.S. agriculture involves the same scientific principles of energy generation and use and the same battle for development and application of scientific breakthroughs involved in the fight for nuclear energy. At stake is nothing less than whether the United States and the world have adequate supplies of the two most basic inputs: energy and food. And as our Indian and Mexican development programs have demonstrated, the keys to *unlocking abundant supplies of energy and food* development are nuclear power and capital-intensive scientific agriculture. These are also the basis for reviving U.S. basic industry and agriculture through a massive export program.

### U.S. at Crossroads

Over the coming decades, the world and especially the developing sector, will be either the scene of further economic and political chaos that leads to ecological devastation and depopulation—if not thermonuclear war—or it can

become a cultured garden supporting a thriving world population. The outcome depends on which of two diametrically opposed policies the United States pursues on a global scale.

We can choose to unleash science and technology in industry and agriculture for global development, as described in the October and November issues of *Fusion*, respectively, or we can implement the recently released *Global 2000 Report* prepared by the White House Council on Environmental Quality and the U.S. State Department. *Global 2000* directly coheres with the just-released World Bank third annual development report and the earlier *Project 1980s* series of the New York Council on Foreign Relations (see *Fusion*, Oct. 1979, p. 36). The logic of these policies, as Secretary of State Muskie has recently noted, translates into a reduction of the world population by 3 billion persons by the end of the century.

The latter prospect is already before us in the horrible form of mass starvation in Africa and the spread of fundamentalist fanaticism in the Mideast. This issue of *Fusion*, therefore, is presented to the American public as another strategic weapon in the arsenal we have been building to restore the rule of reason and science in U.S. and world affairs.

### No Technological Barriers

As this issue demonstrates, there are no physical or technological barriers to providing adequate nutrition for all the world's population. In fact, competent economic analysis shows conclusively that the investments in advanced industrial and agricultural technologies and research to achieve this goal also constitute the *optimal* pathway for future world economic development. That is why it is so important to understand the concept of agricultural and industrial parity policy developed in one of the featured articles.

As things now stand, however, U.S. policy in these areas—regardless of who becomes president—is being determined by an exactly opposite outlook. This policy is euphemistically called "rationalization," or even less appropriately, "reindustrialization," by its proponents. What does such reindustrialization mean? A few high-technology, military-oriented industries are to be built up, while many other basic and consumer industries are triaged. Coal and possibly nuclear power plus ridiculously costly synfuels will be developed in amounts just sufficient to fuel this program, which is aimed more at economic warfare against Western Europe and the moderate OPEC nations than at producing needed energy. Science and technology will be trimmed to fit into this scheme of things; likewise, agriculture—especially in the western United States—and transport will be cut back and tailored to fit the policy. Finally, many parts of the developing sector will be left to wither away and die.

This is hardly the purpose for which U.S. citizens have willingly gone to war or willingly worked overtime to provide a better life for their posterity. It is a policy that is totally alienating our allies in Western Europe, Japan, and in such leading Third World nations as Mexico and India.

### Bad Economics

It is also very bad economics. As we have demonstrated in previous analyses of industrial, scientific, and military policy based on the LaRouche-Riemann economic model codeveloped by the Fusion Energy Foundation, overall rates of productive capital investment and technological innovation must stay above a definite "breakeven" level to prevent economic stagnation and collapse. In fact, they must grow at a rate consistent with the introduction of new, more productive technologies and resources such as fission, fusion, and hydrogen fuel. We will be documenting this fundamental principle of scientific economics in meetings and seminars throughout the country in the months ahead.

In terms of agriculture, the same principle explains why universalization of scientific, high-technology agriculture is both feasible and necessary. Food and science are not luxuries; growing amounts of both are the nourishment civilization requires to safely reach the scarcity-ending era of fusion power.



## Letters

### Indian Reader Comments

To the Editor:

Readers in India have expressed great interest and enthusiasm in recent months over *Fusion* magazine's coverage of the development questions that concern India and other developing countries. I was happy to see *Fusion* at some prominent bookstores in New Delhi as well as at the main magazine distributor, Central News Agency.

Because of the enthusiastic response to *Fusion's* proscience, pro-technology ideas here, I would like to draw attention to some minor inaccuracies in your coverage. Readers in the United States may not pick up some of these errors readily, but some of your readers here feel they are worth correcting.

Let me list three corrections. In the May 1980 issue, *Fusion* reported on a 40-year program for Indian development. The impressive photograph of one of India's nuclear power stations on p. 35 was identified as the Tarapur plant. An engineer who liked the *Fusion* program coverage very much pointed out to me that in fact what is pictured is the *Cirus* experimental reactor at the Bhabha Atomic Research Center in Trombay. On page 48 of the same issue, the mouth of the Brahmaputra river is misidentified. The Brahmaputra river reaches the sea at the Bay of Bengal.

In the September issue of *Fusion*, you have unfortunately misspelled the name of one of India's prominent scientists, Dr. Raja Ramanna.

I bring these small errors to your attention in the hope that *Fusion* will keep up the good work in promoting India's significant scientific contributions in sharp contrast to the zero-growth Club of Rome propaganda that most Indians have gotten used to expecting from the United States.

An Indian reader  
New Delhi

Continued on page 4



## Letters

Continued from page 3

### E-Beam Propagation

To the Editor:

In the July 1980 issue of *Fusion* in an article on particle beam weapons (p. 74), you make the assertion that, in an invited paper given by Winston Bostick (myself) at the Symposium on Dense Plasmas at the APS meeting in New York, March 27, 1980, the author made a statement: The alleged statement is that the relativistic electron beams can travel indefinitely far through the atmosphere if they are composed of vortex filaments. I never made such a statement. There is at

present no experimental evidence or persuasive theoretical arguments to the effect that the filaments play any important role in the propagation of the beam through the atmosphere. If a reporter or editor is . . . expressing his own conjecture that the filaments might play a favorable role, he should clearly and unmistakably characterize the conjectural nature and source of that statement.

Winston H. Bostick  
Professor of Physics  
Stevens Institute of Technology  
Hoboken, N.J.

### The Editor Replies

The specific statement in question reads: "Unclassified research by Win-

ston Bostick and his associates at Stevens Institute and Kirtland Air Force weapons laboratory have also shown that e-beams generated in partial vacuum will spontaneously form a plasma filament that can propagate indefinitely."

Earlier on pp. 69-70, we reported on your presentation to the APS, which did focus on electron beam filamentation but contained no reference to beam propagation properties. In neither section did we attribute any statement whatsoever on beam propagation to you, nor are we aware of any such statement by you.

You are correct that the controversial statement is our own independent evaluation. It was based on the exten-

# The Lightning Rod

My dear friends,

Not long ago, I was up in my attic, rummaging around in a carton of musty old papers, looking for the Lord knows what—my great-great-granddaughter's birth certificate, now that I think of it, which she needed for her trip abroad. Well, of course, I didn't find it and had to write to the town clerk, a most unpleasant fellow, who informed me by returned post that he had "no time for literary hoaxsters such as yourself" . . . but that's another story. And the point of this one is: something curious did turn up in the attic.

That something was the *Global 1900 Report*, famous in its day, circa 1880, as the most shocking and sensational peek into the future of humanity ever produced. It was authored by a man you don't hear much about anymore, Elbert James, the half-brother of William and Henry. You will remember that William James was renowned as

America's most practical man, while Henry James was generally thought to be its most refined citizen. Actually, Elbert was more practical and more refined than either.

Elbert was the true inventor of the trend line, which he created by holding a pencil in front of his nose and following it directly outward along an unrolling cylinder of paper as far as the eye could see. When Elbert applied this method to discern what 1900 might be like, he became seriously alarmed, and succeeded in alarming quite a few others as well.

The first thing Elbert discovered was the equine overpopulation crisis. Because there were more and more people all the time, and always on the go, said Elbert, there were consequently more and more horses needed to transport them. In fact, the horse population was growing even faster than the human, due to the prevalence of the two-horse family in overprivileged countries.

With a few quick calculations on his unrolling sheet of paper, Elbert figured that by 1900, this unchecked growth would produce  $1 \times 10^{23}$  tons of horse manure in the United States alone, or enough to fill the Grand Canyon 250 times over. This, he pointed out, constituted a serious waste-disposal problem.

While the world would clearly be oversupplied with equine by-prod-



Elbert James, father of the trend line.

ucts in 1900, other creatures would be making their way onto the endangered-species list. *Global 1900* foresaw a "beaver crunch" caused by the popularity of beaver hats as gentlemanly attire. Elbert predicted ecological catastrophe if the beaver population were wiped out, for who would be left to build dams and prevent flooding? He initiated a "Save the Beaver" campaign, and troops of militant young ladies picketed the opera

sive public scientific literature on laboratory and astrophysical plasma vortices and reports on preliminary research on e-beam weapons that have appeared in such publications as *Aviation Week*. For example, among the presentations on beam propagation presented at the cited APS meeting by Kirtland researchers were: "Propagation of a Relativistic, Charged Particle Beam Through an Air Medium with Conducting Boundaries" by R.W. Lemke and K.A. Dreyer; "Enhanced Air Resistivity at Low Pressure" by K.A. Dreyer; "Relativistic Electron Beam Propagation As a Function of Pressure" by R.L. Hartley, K.A. Dreyer and D.C. Straw; *Continued on page 7*

in order to hiss at the beaver-hatted gentlemen sauntering in and out. Solemn editorials were written in the *New York Times*.

To conserve energy and forestall an inevitable candle shortage, Elbert urged a national wax-recycling program, with government inspectors sent around to check everyone's ears to make sure nothing was being wasted. *Global 1900* ridiculed talk of an electric lightbulb as "unproven speculation."

As you might imagine, the 20th century, when it finally rolled around, was a big disappointment to Elbert. The horseless carriage was a bad blow, but the Wright Brothers really broke his spirit. Shortly after Kitty Hawk, Elbert faded from public life, destined to spend his remaining years sitting atop a mountain of horse manure declaiming against "soulless materialism."

His methods, however, live on.

Your obt. svt.,



*Postscript: The editor tells me there is an article on the sequel to Global 1900 in the Washington news section.*

## New from The New Benjamin Franklin House

### BASIC ECONOMICS for CONSERVATIVE DEMOCRATS

Presidential candidate Lyndon LaRouche lays out the principles of economic development—upon which his campaign is based—and explains why the austerity policies of Carter, Volcker, and "kook-economist" Milton Friedman are aimed at destroying American society.

Now in its second printing of 15,000 to meet the demand for scientific solutions to the economic collapse Carter has unleashed on the country.

176 pp, paper, illus.

\$3.95 list price.

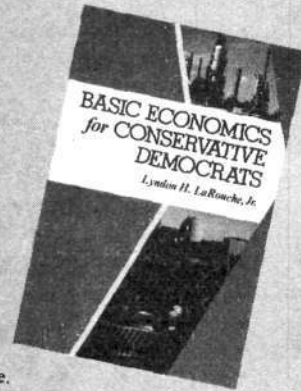

### THE NEW DARK AGES CONSPIRACY

#### London's Plot to Destroy Civilization

This story of the British intelligence-centered conspiracy to enforce "zero-growth" genocide on the entire world damns the conspirators—including H.G. Wells, Bertrand Russell, Aldous Huxley, and George Orwell—with quotes out of their own mouths. Author Carol White proves that Nazi Germany was merely one "act" in London's script, developed at the turn of the century, to maintain British power at the expense of the human race.

First printing of 15,000, the companion volume to Franklin House's continuing bestseller, *DOPE, Inc.*

approx. 480 pp, paper, illus. \$4.95 list price



\_\_\_\_\_ copies of **Basic Economics**

\_\_\_\_\_ copies of **The New Dark Ages Conspiracy**

MasterCard/Visa # \_\_\_\_\_ Interbank # \_\_\_\_\_ Exp. date \_\_\_\_\_

Name \_\_\_\_\_

Address \_\_\_\_\_

City \_\_\_\_\_ State \_\_\_\_\_ Zip \_\_\_\_\_

Available from: *The New Benjamin Franklin House Publishing Co., Inc.* c/o Campaigner Publications, Dept. F  
304 W. 58th Street New York, N.Y. 10019

(All checks and money orders payable to The New Benjamin Franklin House)

Please add \$1.00 postage/handling for single-copy order; \$0.50 per book for multiple orders up to 10; \$0.25 per book for orders more than 10 copies

FUM-4



# Viewpoint

## Agricultural Research: A Sure Investment

by B. R. Eddleman



**P**ast growth in food and agriculture has come from two sources—increases in the volume of production resources used to produce food, fiber, and wood, and productivity increases caused by improved efficiency in the use of resources. The publicly funded system of research, extension, and higher education in the food and agricultural sciences has been a prominent contributor to productivity growth in the food and agriculture system.

We must concentrate on efficiency of resource use as we look to the future. We must find ways to get more food, fiber, and wood from available resources at less cost—whether measured in dollars, energy, environmental impacts, or some other way. We must enhance scientific and technical progress now if the technological reservoir is to be continually replenished.

This will require focus on the more basic or fundamental aspects of agricultural science and technology, rather than simply looking at short-run stopgap measures to deal with

current economic difficulties. Such focus requires the development of new energy-efficient technologies for agriculture instead of current emphasis on using biomass for energy, organic farming, and so on.

These needs require redirection of existing research and education efforts and substantial new investments in the food and agricultural sciences. A recent study concluded that the annual rate of productivity growth in agriculture has been approximately 1.5 percent per year for the past 50 years, but took an alarming drop in the late 1960s and early 1970s.

Although productivity growth has recovered in recent years, this study concluded that it may drop to 1.1 percent or lower between now and the year 2000 if no substantial increases in real investments in agricultural research and education are made and no new and unprecedented technologies emerge.<sup>1</sup>

A second study examined the impacts on food costs to American consumers that would result from allowing a 10 percent lower funding base

(in terms of real dollar support) to occur for agricultural research and education. The cumulative effects for the two decades between 1980 and 2000 result in productivity lagging behind its historical rate of growth.<sup>2</sup>

This lag in productivity would result in lower rates of expansion in the quantity of food produced and consumed and in higher prices each year. The costs to the American consumer far outweigh the savings in government expenditures for agricultural research and education. A net social cost of \$10.8 billion in 1977 dollars over the two decades was determined.

### Agriculture at a Crossroads

In essence the U.S. food and agriculture system is at a crossroads. Current technologies can be continued with a resulting drop in the productivity growth rate and competitiveness worldwide. Or new energy-efficient technologies can be developed to keep this nation's food and agriculture system the most important in the world. These new technologies are vital because the food and agriculture sector has become the major stabilizing and growth sector in the domestic economy.

A rapid transition to new energy-efficient technologies cannot occur without substantial increases in public funding for the food and agricultural sciences. Growth in public investments in agricultural research and education since the mid-1960s has dropped alarmingly compared to the previous two decades. Total public funding for agricultural research has increased only 1.9 percent annually since 1967 compared with a 3.9 percent annual compound growth rate during 1939-1967, measured in terms of constant 1967 dollars.

Federal funding of food and agricultural research through the USDA and other federal agencies has increased only slightly since 1967 despite rapid growth in agricultural exports and food crises of global dimensions in the mid 1960s and early 1970s.

Failure to invest in scientific and technical progress will result in slower productivity growth in the food and agriculture sector. Slower rates of expansion in farm output will diminish the contribution of the U.S. food and agriculture sector to the domestic economy and export trade. This will eventually worsen America's ability to contribute to the solution of malnutrition that is now ravaging millions worldwide.

In the past, new technological discoveries from the national food and agricultural research effort and the adoption of these technologies by business firms provided increased efficiency to offset rising costs. The benefits to society were actual decreases in real food costs to American consumers when viewed as a percentage of disposable income. However, unless a dramatic increase in real public funding of agricultural research and education is made, American consumers may experience real food costs more in line with those of other developed countries. Higher real food costs result in a disproportionate burden on low-income families who must spend more of their income for food.

Certainly, the current level of public investment in the food and agricultural sciences is insignificant compared to the benefits derived by the general public.

*Dr. Eddleman, an economist, directs the National Regional Research Planning and Analysis Agricultural Experiment Stations. This viewpoint column is adapted from his paper supporting the fiscal year 1982 budget request of the U.S. Department of Agriculture's Science and Education Administration.*

#### Notes

1. Yao Chi Lu, Phillip Cline, and Leroy Quance, "Prospects for Productivity Growth in U.S. Agriculture," *Agri. Econ. Report No. 435*, ESCS, USDA, Washington, DC, Sept. 1979.
2. Fred C. White, Joseph Havlicek, Jr., and Daniel Otto, "Agricultural Research and Extension Investment Needs and Growth in Agricultural Production," *A.E. 33*, Dept. of Agri. Econ., VPI & SU, Nov. 1978.

## Letters

*Continued from page 5*

and "The Effects of Foil Scatter on Propagation of a 1.4 MeV Electron Beam in Neutral Gas" by J. Thorne and M.C. Clarke.

Dr. Morris Levitt  
Editor-in-Chief

### Particle Beam Weapons

To the Editor:

... Several of your last few issues have referred to the development of energy beam weapons. In April 1979, an article appeared in *Scientific American* by John Parmentola and Kosta Tsipis titled "Particle Beam Weapons." As I understood it, their basic point was that energy or particle beam weapons would not be practical in any form (land based, sea based, or space based) because they depend on some kind of radar guidance system that could be easily and totally blinded by exploding a single nuclear bomb in the vicinity of the weapon or its guidance system, then following with the main attack. Their arguments are very persuasive. None of the articles I have read in *Fusion* speaks to this criticism of the technology.

If their arguments are correct, we need not worry about Soviet e-beam systems being a military threat (though such systems still may, of course, lead to a technologic superiority in inertial fusion systems), and we in the United States should not waste funds on developing similar systems when such money could be better spent developing fusion power generator systems.

Martin H. Goodman, M.D.  
Oakland, Calif.

### The Editor Replies

The use of nuclear weapons to create a plasma fog or burst of radiation as a defense against beam weapons is undoubtedly practical. However, the existence of countermeasures has never yet invalidated a weapons system: There are anti-aircraft guns, but we still use airplanes; there are anti-armor weapons, but tanks are still effective. The question, as military strategists have known since Clausewitz, is firepower: that is, how pow-

erful and how well deployed is the weapon. The beam weapon is not a death ray. It is merely part of an effective antimissile defense system.

Once the beam weapon is evaluated in this context, its usefulness is obvious, and the drawbacks of the nuclear burst as a defense must be considered. Such a burst would disable the guidance systems on our incoming missiles as well as the enemy's beam weapon; such a burst would blind our own observation satellites, dramatically decreasing our own guidance and surveillance capabilities during the first minutes of war; and, most important, such a burst would require the diversion of a large number of nuclear weapons from deployment against terrestrial targets.

Finally, the existing evidence indicates that the Soviets are developing prototype e-beam weapons systems from this standpoint. Our own position is that there should be the maximum international cooperation on inertial fusion research, which is presently prevented by overly restrictive classification policies.

Dr. Steven Bardwell  
Associate Editor

### Against Rock Music

To the Editor:

I think that it is entirely appropriate for *Fusion* to take an editorial stand against rock music, as mentioned in the Letters section of the August issue. Music, like the physical sciences, is not value-free, but is, as Plato understood, a powerful educational tool. Unfortunately, rock music "educates" the individual toward a world view that is egoistic and anarchistic, the "be-here-now" outlook that characterizes an infant. On the other hand, the current of music exemplified by Beethoven inspires the individual to take on the responsibility of shaping history, and arms him with the epistemology needed to do so.

To build a fusion-based economy, we will require more Beethovens as well as more Riemanns.

Daniel Platt  
Los Angeles, Calif.



# House Passes Historic \$20 Billion Fusion Bill

*Editor's Note: This late news section on the passage of the House fusion bill was written as Fusion went to press and replaces the usual News Briefs department and Lousewort Laurels.*

\* \* \*

By an overwhelming margin Aug. 25, the House of Representatives passed the single most important piece of energy legislation of the decade—a 20-year plan to develop commercial fusion.

The 365 to 7 vote for the Fusion Energy Research, Development, and Demonstration Act of 1980, HR 6308, introduced by Washington Democrat Mike McCormack in January and cosponsored by 159 members of the

House, mandates the Department of Energy to develop a program plan to demonstrate the commercial feasibility of magnetic fusion energy by the turn of the century. The bill authorizes an overall magnetic fusion expenditure of \$20 billion in the course of a 20-year program.

In a telegram to McCormack Aug. 26, Fusion Energy Foundation executive director Dr. Morris Levitt congratulated the congressman "on behalf of the 10,000 members of the FEF and the many thousands of *Fusion* readers who have enthusiastically backed your fight for an Apollo-style fusion program."

"This gives the nation a real weapon in the fight to put the United States back on the road to economic prosperity and to revive our position as

scientific world leaders," Levitt said.

The bill commits the nation to demonstrate engineering feasibility of magnetic fusion energy by 1987 with the construction of an Engineering Test Facility. After that milestone is reached, the first experimental fusion power reactor would be developed before the year 2000 to produce net power and demonstrate that utility-based electric generating power plants are ready for commercial deployment.

In motivating the need for an aggressive research, development, and demonstration plan, the bill states that "the early development and export of fusion energy systems will improve the economic posture of the United States and ultimately reduce the pressures for international strife by providing access to energy abundance for all nations."

Sources in the Energy Research and Production Subcommittee of the House Science and Technology Committee are optimistic that the near-unanimous mandate from the House will help propel the Senate fusion bill, S2926, through the Senate Energy Committee mark-up and to the Senate floor for a vote in mid-September. The bill was introduced in July by Paul

## 'A Great Day in Man's History'

*Here is a sampling of the comments of congressmen and others concerned with fusion development on HR 6308. The congressional statements were published in the Congressional Record.*

\* \* \*

### Rep. Mike McCormack (D-Wash.), Aug. 25

We must understand our place now in history. I predict that future generations will view our decision on energy development today as a decisive turning point. We will have available to us, and the world, limitless

energy. We are presently a society in transition, the transition from old energy sources to new ones, and when we step across the line into the world of controlled magnetic fusion, as we can do before the year 2000, we will be taking the most important step in the history of mankind. . . .

Many, many times it has been said that if we put a man on the Moon, we should be able to solve the energy crisis. Well, the energy crisis is far more complicated than putting a man on the Moon. . . . But over and over again there has been a call for an Apollo-type program in energy, and in this bill we are actually setting up an Apollo-type program with a goal equivalent to putting a man on the Moon. So within the next 20 years, we expect to have a fusion demonstration plant on line. This is very similar to our Apollo program as conducted by NASA. . . .

In the last two years we have learned what the answers are to move ahead. Now, we need technological development. We have shown in the past, with the Apollo space program, that we can control the rate of progress in these development programs. We can have a fusion energy production facility on line before the turn of the century if we are determined and willing to make the commitment. . . .

### Rep. Jim Wright (D-Tex.), House Majority Leader, Aug. 25

It is a great day in the history of the human race when we make yet another commitment to express our faith in the future and in man's capacity intelligently to pursue those infinite secrets of the universe which God has seen fit to reveal to us at this moment in man's history when the growing population of a hungry world may be eating our way through the

Tsongas, a Massachusetts Democrat, and has 16 cosponsors.

The Tsongas bill has a less optimistic timescale than the House bill and does not authorize funding for the magnetic fusion effort to the completion of a commercial demonstration reactor. However, the bill is now being revised by the subcommittee staff to reflect comments and criticisms made by the fusion scientists at subcommittee hearings Aug. 5. (See Washington section, this issue.)

#### What's Next

If the Senate fusion bill passes with significant differences from the House bill, a conference committee will have to work out the differences. The main question, however, is will the president sign the fusion bill into law? Although President Carter had expressed his general support for fusion in April in reply to a letter from Congressman McCormack, the administration has been unwilling so far to support the aggressive upgrading of the fusion program outlined in the McCormack bill.

There are two pressure points that may compel the president to sign the fusion bill—in addition to its widespread support in the fusion community and Congress.

First, the Democratic Party platform gives the president a clear mandate on fusion. The platform reads: "The Democratic Party vigorously supports substantial funding for the construction of an engineering test facility for fusion technology. Fusion is a safe, clean, alternative source of energy which can be used to generate electricity efficiently."

Second, the June report of the Fusion Review Panel of the Department of Energy's Energy Research Advisory Board supports the acceleration of the U.S. magnetic confinement fusion program and recommends that the DOE upgrade the program in order to ensure that prototype fusion electric power plants will be a reality by

the year 2000. The Buchsbaum Report, as the panel's report is known, was unanimously approved by the full advisory board in August and now is on the desk of Energy Secretary Duncan.

Commenting on the House bill, Congressman McCormack told *Fusion*: "I am optimistic that the Senate will pass their version of the bill just passed in the House and that the bills can be brought together with the endorsement from the administration's own ERAB [Energy Research Advisory Board] review. The Senate has moved aggressively in putting a bill together and speedy action on their part will no doubt lead to a bill to go to the president before this session of Congress is out."

### What Fusion Supporters Can Do

- *Telegraph, write, and phone your senators and the White House to tell them of the importance of accelerating the U.S. fusion program to demonstrate fusion feasibility by the year 2000.*
- *Call your local newspaper and radio and TV stations to encourage coverage of the fusion issue. The FEF has press packets available on the U.S. fusion effort and spokesmen are available for interviews.*
- *Contribute to the FEF! Your tax-deductible contribution will help the FEF continue to educate the public about fusion and its benefits. The FEF plans public service TV spots and distribution of a slide show on fusion.*

old resources of power such as oil and coal and without new sources might face famine. By this action we express our belief as well that perhaps in His infinite wisdom the Almighty may have divined in our increasing awareness a capacity to apply the laws of moral social behavior which are corollary to the physical laws of the universe in such a way as to make the atom finally man's servant and not his destroyer.

...This particular piece of legislation may be one of the fatefully significant decisions that we shall make in this Congress or in this decade. We are here committing ourselves to a Manhattan-type project, accepting the rightful priority of the potential of nuclear fusion as a primary goal of the United States. ... There always have been at each step up the path of man's increasing physical knowledge those who have balked and dragged

their feet, fearful perhaps that we were invading the exclusive domain of the Deity and about to incur the wrath of God. When aviation was in its infancy, some insisted that if God had intended man to fly, He would have endowed us with wings in the first place. ...

#### Edward Frieman, director, Office of Energy Research, DOE, Aug. 28

In general, I think the bill is coming out roughly where we were tending to head. It agrees with the review of the Energy Research Advisory Board, although I think that review was more in line with the Senate bill. The major thrust is that magnetic fusion is ready to move into the engineering development phase and out of the research stage. Everyone is in agreement with this. It is the overall view that the fusion program is ready to move in a major way. Changes in circumstances

in fusion research are changing the administration's view of this.

#### Dr. John Emmett, director Lawrence Livermore Laboratory Laser Program, Aug. 28

It's terrific. It's a truly great moment for the United States in both the magnetic and inertial fusion programs.

#### Dr. Stephen O. Dean, president Fusion Power Associates, Aug. 27

The passage of the McCormack bill along with the endorsement of the Buchsbaum report from the Energy Research Advisory Board of the Department of Energy are clear signs that Congress and the administration will come out with more aggressive fusion programs next year. We should support getting all parts of the policies needed for an accelerated program done as soon as possible.

*Continued on page 86*



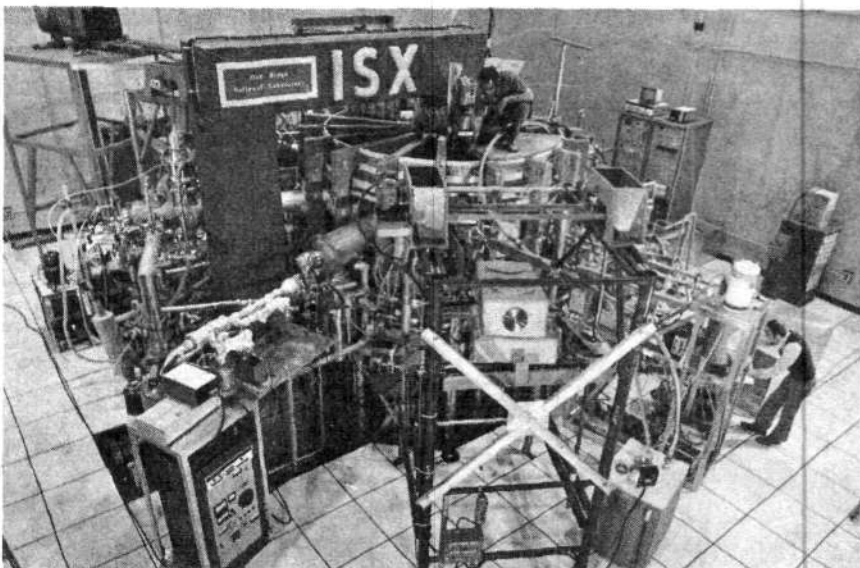

The ISX tokamak at Oak Ridge: Record plasma beta results.

## Alcator Results Show 'Quenching' of Density Scaling

The initial experimental results from the Massachusetts Institute of Technology Alcator C high-field tokamak indicate that the previously observed increase in plasma confinement time as plasma density increases appears to quench (that is, subside) at high densities.

The Alcator C results were reported by the MIT group at the 8th International Conference on Plasma Physics and Controlled Nuclear Fusion sponsored by the International Atomic Energy Agency in Brussels July 1-10.

Until now, the general empirical scaling law found in tokamak experiments is that the plasma energy-confinement time is proportional to the product of the plasma density times the square of the plasma column's diameter. The initial Alcator C results show that although this holds for densities up to  $6 \times 10^{14}$  plasma electrons per cubic centimeter over a wide range of magnetic field strengths (60 to 95 kilogauss) and plasma currents (0.25 to 0.54 million amperes), at larger plasma densities "the global energy confinement increases with

density more slowly than the conventional scaling predicts."

### ISX Results Similar

A similar type of behavior has been observed in the neutral-beam-heated Oak Ridge National Laboratory's ISX tokamak experiment, a phenomenon called *density clamping*. During neutral-beam-injection experiments, when the density of the plasma gas is made to rise linearly with constant gas injection, it is found that the density of the plasma "clamps" and cannot be increased shortly after neutral beam injection is begun.

In the ISX, this density clamp has been overcome by applying a short, intense gas puff just before start of beam injection.

The ISX has obtained record plasma beta results of 0.08 and more at peak. (Beta, the ratio of the plasma gas pressure to the pressure of the magnetic field, is a measure of the efficiency with which a magnetic field confines a hot plasma.) These values exceed the theoretically predicted MHD beta limit, but no instability is actually observed.

## Brussels Conf. Reports Advances In Inertial Fusion

The recent groundbreaking high-density experiments on the Shiva laser system have generated hydrogen densities more than 50 times liquid densities, John Emmett, director of the Lawrence Livermore laser fusion program, announced at the inertial confinement session of the IAEA 8th International Conference on Plasma Physics and Controlled Nuclear Fusion in Brussels.

The most surprising of the inertial confinement reports given at the July conference was that of the Japanese laser fusion research group led by Dr. Yamanaka of the Osaka University laser program. Yamanaka reported on the group's recent laser fusion experiments and their extensive plans to build a 40-terawatt glass laser system within the next few years. This Japanese glass laser, Gekko XII, will be more powerful than the 30-terawatt Shiva at Lawrence Livermore, now the world's biggest laser.

A.A. Offenberger of the University of Alberta, Canada reported new experimental results with high-power carbon dioxide lasers indicating that stimulated Brillouin backscatter may not be as devastating as had previously been thought.

Less than 30 percent of the incident laser light was reflected, which is far less than the 60 percent previously observed, Offenberger noted. "In a time interval of 7 to 10 nanoseconds following SBS [stimulated Brillouin backscatter] nearly complete absorption occurs after which target burn-through and refraction dominate. Little energy is scattered sideways," Offenberger reported.

More efficient absorption of carbon dioxide laser light can now be expected in laser fusion experiments.

### Test Firing of Sandia Accelerator Is Successful

The 36 modules of the particle beam fusion accelerator PBFA-I being constructed at Sandia National Laboratories in Albuquerque, N.M. have been fired simultaneously for the first time, producing 840 kilojoules (kJ) of energy and 20 trillion watts (TW) of power in a 40-nanosecond pulse.

Test firing of the machine—not yet equipped with a central diode or target chamber—marked the completion of the accelerator's construction and assembly phase, on time and within the budgeted cost of \$14.2 million. The machine is capable of irradiating targets with either ions or electrons, although the ion approach will be emphasized.

"It was a successful first test of the accelerator," said Dr. Gerold Yonas, director of Pulsed Energy Programs at Sandia, "and we expect no major problems in bringing the machine up to its nominal operating level of 1,000 kJ and 30 TW."

PBFA-I will operate until 1983, when it will be shut down for an upgrade to PBFA-II. Each of the 72 modules of PBFA-II will produce about 4 million volts and 350,000 amps, giving the upgraded machine a total output of 3,500 kJ and 100 TW in 40-nanosecond pulses. Testing will begin in 1984.

PBFA is an experimental accelerator that will irradiate only single pellets, producing insufficient fusion reactions to explore reactor technology fully. However, success in the experiments could ultimately lead to construction of an experimental power reactor, which could be in operation within 20 years after pellet ignition principles are established.

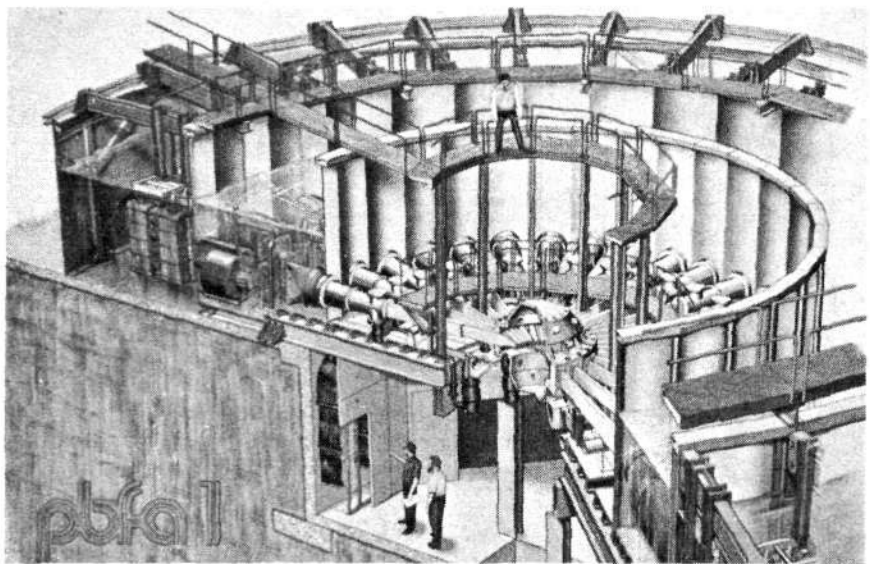

Artist's conception of the Sandia particle beam fusion accelerator, PBFA-I. The system injects power radially into a central chamber toward a fusion target.

### Fusion Scientist Calls for Declassification

Dr. Ray E. Kidder, a pioneer in the development of the U.S. inertial and laser fusion program at Lawrence Livermore Laboratory, has issued a call for the declassification of inertial-confinement fusion research. Kidder argues that although there are general theoretical connections between inertial-confinement fusion microexplosions and thermonuclear weapons, in reality the actual research and designs needed in fusion are not directly applicable to thermonuclear weapons. To the extent that specific connections do exist, these are now well known and have been put in the public record, as in the case of the famous Morland article in *The Progressive*.

Dr. Kidder continued: "With regard to the question of proliferation, it should be recognized that information concerning fusion microexplosions, which involve neither fission nor high explosives, has little to do with the design of fission bombs, the *sine qua non* of nuclear weapons proliferation.

"I therefore believe that nothing of substance is lost by declassifying the ICF [Inertial Confinement Fusion] Program. What is gained?"

"It was pointed out in the 1970 Final Report of the Defense Science Board Task Force on Secrecy (Frederick Seitz, chairman) that:

"The negative aspect of classified information in dollar costs, barriers between the United States and other nations and information flow within the United States is not adequately considered in making security classification determinations. We may gain far more by a reasonable policy of openness because we are an open society."

"This general conclusion is especially applicable to the ICF Program, which is international in scope, being actively pursued by Canada, England, France, Germany, Italy, Israel, Japan, China, and the U.S.S.R.

"A policy of openness would not only permit cooperation between nations, but would permit full participation in the ICF Program by the nation's universities, an involvement that could be expected to substantially accelerate progress toward the ultimate goal of energy production. Such was the experience with the Magnetic Confinement Fusion Program, which flourished after its declassification in 1958."



## Fusion Bills Expected to Pass Congress

See news update on the fusion bill, page 8.

Congressional sources are hopeful that both the House and Senate fusion engineering bills, introduced by Congressman Mike McCormack (D-Wash.) and Senator Paul Tsongas (D-Mass.), respectively, will be passed by both Houses of Congress before this session of Congress adjourns at the end of the year.

Congressmen McCormack expects to have HR 6308 placed on the House calendar during August; the Senate Energy Committee plans to mark-up S 2926 and send it to the full Senate floor by September.

Senator Tsongas along with six initial cosponsors submitted the Magnetic Fusion Energy Engineering Feasibility Demonstration Act of 1980 on July 2. Although the bill itself compromises on the question of the pace of development for magnetic fusion, fusion scientists and House Science and Technology Committee staff members expect that changes will be made in the Senate bill before it reaches the floor.

If there are significant differences between the House and Senate versions, they will be ironed out in a conference committee, and the resulting bill passed by both Houses. Such a landmark fusion bill will make the commercial development of magnetic fusion a national priority with a mission to demonstrate engineering and commercial power production feasibility in the next 20 years.

Unlike the McCormack bill on the House side, the Tsongas bill did not have input from the leading fusion scientists. The resulting problems with the bill were discussed during a morning of informal hearings held by the staff of the Research and Development

Continued on page 14

### Tsongas Comments on Fusion, FEF

At the first day of hearings on his fusion bill July 27, Senator Paul Tsongas startled the assembled representatives of the fusion community two times. First, he announced that he saw fusion as an "alternative" to the nuclear breeder.

Second, the senator lashed out at *Fusion* magazine: "The issue that I saw recently suggested a direct link between drugs and the antinuclear movement," Tsongas complained to those present, and he asked the industry representatives there whether they were associated with the Fusion Energy Foundation.

Tsongas questioned Dr. Stephen Dean, president of Fusion Power Associates, about the FEF as he began his testimony. Dean, a former director of the DOE magnetic confinement division, replied:

"I can't comment on behalf of the FEF. . . . Fusion people attempt to treat the variety of different people that come to us equally and respectfully, independent of whether we agree with their political views. . . . Some of the comments and positions taken by the FEF are in fact positions which we support on their merits: namely, that fusion is in fact an important element in our long-term energy policy.

"Also we believe that high technology and technology in general in this country has got to be supported. Otherwise this country will become a second-rate technological force in the world; in fact, it will damage our economic competitiveness in the world and our standard of living in the long run."

#### Levitt Replies

In a statement released July 30, FEF executive director Dr. Morris Levitt commented that "although the senator's outburst was politically inspired, it usefully raises a basic issue in the reindustrialization debate—that is, we can't have fusion without fission."



Suzanne Klebe/NSIPS

National fusion laboratory directors recommend accelerating the Tsongas bill timetable and budget. From left: Dr. Tihiro Ohkawa, General Atomic Company; Dr. T. Kenneth Fowler, Lawrence Livermore Laboratory mirror fusion program; and Dr. Melvin Gottlieb, Princeton Plasma Physics Laboratory.

## Fusion Bills

Continued from page 13

opment Subcommittee of the Senate Committee on Energy and Natural Resources Aug. 5.

Invited to comment on the legislation were the directors of the major magnetic fusion programs in the country, including Dr. Melvin Gottlieb, director of the Princeton Plasma Physics Laboratory; Dr. Lee Berry, the head of the Oak Ridge National Laboratories fusion program; Dr. T. Kenneth Fowler, the director of the Lawrence Livermore mirror fusion program; Dr. Ronald Davidson, head of the fusion program at MIT; and Dr. Tihiro Ohkawa, vice president for fusion at the General Atomic Company.

Edwin Kintner, the director of the DOE fusion program, and Dr. Al Mense from the House Science and Technology Committee staff were also invited to participate.

The national laboratory heads were unanimous in their criticisms.

MIT's Davidson stated emphatically that the bill's proposed seven-year period in which to double the fusion budget (in real dollars) was unnecessarily long. "In my opinion, a doubling of the present funding level . . . within a four to five year period is certainly justified on the basis of technical progress and promise."

### Timetable Criticized

A second criticism concerned the timetable for both the next-step engineering demonstration facility and later commercial feasibility demonstration. The House bill sets these two milestones at 1987 and 2000, respectively; the Tsongas bill proposes 1990 (at the latest) and 2005.

According to the scientists, who have engaged in fusion research for an average of nearly 20 years each and have responsibility for hundreds of millions of dollars of experiments and 4,000 scientists and engineers, the McCormack bill's earlier milestones are perfectly feasible.

The lab directors also made it clear that an acceleration of the tokamak program would not hinder alternate

fusion approaches. For example, during the discussion of the 2005 versus 2000 goal for commercial demonstration, committee staff director Will Smith asked Dr. Fowler if speeding up the front-running tokamak magnetic fusion effort into the engineering and commercial phases would not take funding and support away from an alternate fusion program such as the magnetic mirror.

Fowler, who heads the magnetic mirror program at Lawrence Livermore Laboratory, stated that, on the contrary, the progress made in the tokamak program has greatly benefited the other magnetic fusion concepts and cut time off their development schedules, since much of the technology can be shared.

"I don't believe in holding the program back," Fowler stated. "That would slow down everything. Holding off the decision to build a tokamak engineering test facility until 1984 means that we're not sure we can do it. It would be presumptuous to say we won't take the opportunity that's available to us now."

### Needless Bureaucracy

The other major criticism by the scientists concerned the proposal in the Senate bill to create various advisory committees for laboratory directors and to have a technical panel of the DOE Energy Research Advisory Board evaluate progress in the program every year. Committee staff director Will Smith indicated these sections would be changed or deleted, after the scientists pointed out that needless bureaucracy was being created—advisory panels already exist—and the DOE advisory board in question would hardly be able to handle the task of review on an annual basis.

The Senate subcommittee staff sent a "dear colleague" letter to all Senators Aug. 5 inviting them to join in cosponsoring the Tsongas bill. If both fusion bills proceed through Congress as expected, the nation could have a national fusion engineering and commercial demonstration mandate before the end of this year.

## Carter Space Policy Under Attack

The nation's most experienced authorities in space policy scored the Carter administration for failing to set long-term goals for the U.S. space program at an extraordinary hearing July 24 of the Space Science and Applications Subcommittee of the House Committee on Science and Technology.

Brought before the subcommittee to discuss the long-range goals of the civilian space effort, former administrators Tom Paine and James Fletcher and associate administrator Rocco Petrone joined current NASA head Robert Frosch in contesting the White House position, presented by President Carter's science advisor Frank Press.

Press, who heads the Office of Science and Technology Policy, stated that it is "premature" to commit the nation to a high-challenge space effort comparable to the Apollo program of the 1960s. A large-scale effort in the range of \$25 to \$100 billion



Frank Press: Large-scale space effort "premature."

would not be seen until "well into the next century," Press stated.

Subcommittee member John Wydler (R-N.Y.) asked Press, "Is there anything new in the president's policy? It strikes me as carrying on programs that were underway. The thing that bothers me is the continuing feeling of living off the past. What will there be to build on 10 years from now?"

Press said the administration is committed to completion of the shuttle program. Although these projects were initiated by other administrations, he said, "that doesn't bother me."

"Obviously," Congressman Wydler shot back.

#### Lack of Goals

Paine, Fletcher, and Petrone stressed that the real problem facing the space program at this time, even more than the budget-cutting mania that has swept the White House and Capitol Hill, is the lack of long-range goals and a future for the nation's exploration of space. This lack of goals for NASA has led to an "attitude of indifference" on the part of the American public.

Tom Paine, who headed NASA at the end of the Johnson administration, told the subcommittee: "We are on the threshold of a new era in space made possible by the space shuttle. Yet, we seem to have lost both our sense of direction and our resolution. The bold, successful, and rewarding space initiatives of the 1960s stand in stark contrast to today's irresolution and drift."

Fletcher, NASA administrator under Presidents Nixon and Ford, stated, "I do not agree at all that large high-technology programs are 'premature and unfeasible.'"

Even Robert Frosch, at risk of a dressing down from the administration, disassociated himself from Press's defense of Carter policy.

The Aug. 8 issue of the French daily *Le Figaro* commented very unfavorably on administration spokesman Press's statements, reflecting European concern about the lack of U.S. direction for the space program.

## Global 2000: An Environmentalist Nightmare

The White House Council on Environmental Quality and the Department of State released the Carter administration's *Global 2000 Report to the President* July 24, a gloomy collection of zero-growth predictions.

The report's methodology was to assume the level of industrial and agricultural technology operating in 1975 and predict how woefully inadequate these capacities would be for global economic and social needs in the year 2000. The *Global 2000 Report* took two years to prepare.

According to the report's conclusions, nearly 1.2 billion of the world's people will face malnutrition and disease at the turn of the century, compared to 400 to 600 million people today. Population growth will outstrip the production of food at today's prices, making nutrition unavailable to a larger percentage of the world's people than today, since overall GNP growth will not provide them with the income to buy food.

Energy will continue to rise in price, the report says, regardless of inflation, making "conservation" and expensive alternative energy sources "economical." The world's forests and mineral resources will become scarce and will continue to be consumed primarily by the few industrialized nations of the world.

#### 'Carrying Capacity'?

By the year 2030, the earth's population will approach the 10 billion mark, and in the year 3000 will hit the 30 billion level, which the National Academy of Sciences has decided is near the absolute "carrying capacity" of the entire earth. Water, clean air, arable land, and fishing reserves will be under fierce competition. The gap between the OECD and less-developed nations will increase.

This state of affairs is probably undesirable, *Global 2000* says. The solu-

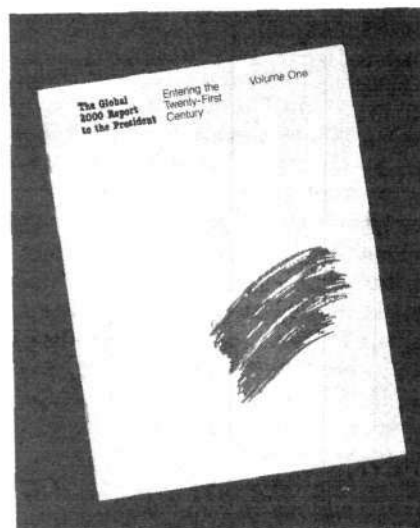

*The Global 2000 Report: The gloom and doom starts at the cover.*

tion? Conserve energy and limited natural resources, induce family planning and population control techniques, and accept the notion that there are no "quick fixes" that "revolutions in technology" can provide.

Reflecting the Carter administration's view that nuclear energy is dangerous, uneconomical, and unrenewable, energy projections by the report leave no hope for providing the world with energy. By limiting itself to conventional fishing and soil-based agriculture, today's energy-intensive agricultural technology will be too expensive for most of the world.

#### No Innovation

The last page of the report states gloomily that upon entering the 21st century, the "world will be more vulnerable both to natural disaster and to disruption from human causes. The tensions that could lead to war will have multiplied," and the world will be more vulnerable to the disruptive effects of war. This is the only point at which the report's pervasive Malthusianism touches upon reality.



## NERO Symposium Promotes Nuclear Alternative

At a July 22 symposium on nuclear energy sponsored by the industry-based National Energy Resource Organization on Capitol Hill, Congressman Mike McCormack assailed the Carter administration policies of energy conservation and outlined a full nuclear program to produce 400 to 500 nuclear plants by the end of the century.

The Carter administration's "conservation" program is unrealistic, McCormack said, and he berated the administration for "not telling the truth to the American people" in regard to nuclear energy.

"The Department of Energy does not publish one document on nuclear power," he said. "The one in process is being held up by the countercul-

ture activists who don't want people to even know what a reactor looks like."

The Washington Democrat, the first recipient of NERO's service award, outlined a series of measures that must be taken to ensure that nuclear power remains a major part of the nation's energy picture:

- The Nuclear Regulatory Commission must be reformed—"it must not be a body that is hostile to nuclear power, it should just regulate it."

- There should be "licensing law reform so it doesn't take more than seven years to put a plant on line."

- The National Environmental Protection Act is a "weapon to prevent almost anything from getting built in this country." Congress "must rewrite NEPA, the clean air act, and others so they do what they are intended to do."

- "We must commit ourselves to nuclear power production as a nation—this must come from the White House. The president has to say that

nuclear energy is the cheapest, safest, most reliable form of energy."

- We must get the entire "fuel cycle in shape. Part of it is public, part is private, and part has been stopped altogether." McCormack advocated a federal fuel cycle corporation to build the fuel recycling, enrichment, and breeder facilities needed to close the nuclear fuel cycle.

Because the administration nuclear policy has been so "destructive," McCormack said, Congress must take the initiative on three types of nuclear bills. These include a fusion bill, a nuclear waste bill, and a bill to coordinate nuclear safety programs.

Other speakers supported the congressman's overall thrust. Fusion Power Associates president Stephen O. Dean stressed that "unless fission becomes an acceptable form of energy production, there will be problems for fusion. Fusion technology depends upon a viable nuclear technology for materials development and power components."

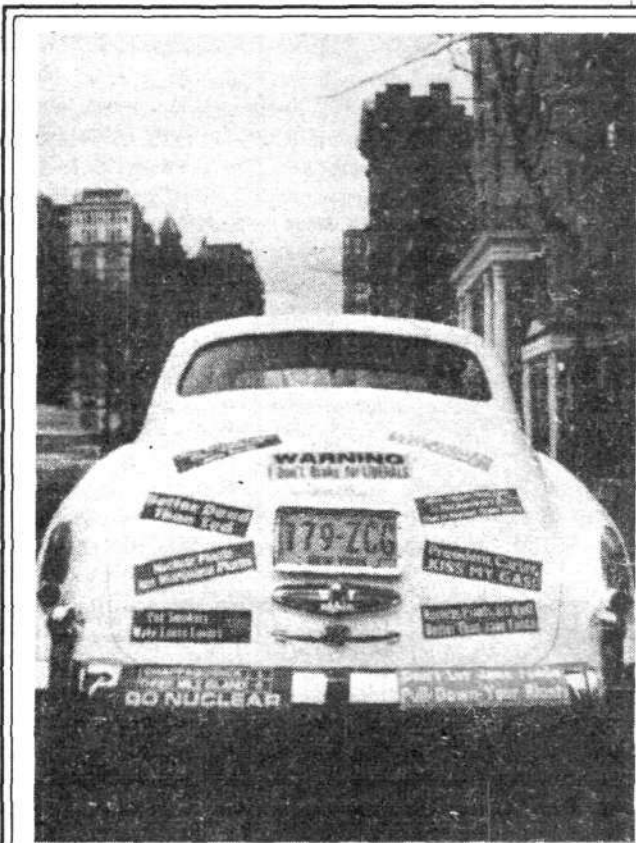

## You can afford to express your opinion

The bumper stickers that say it all.  
All vinyl; will not fade

Order by letter \_\_\_\_\_

- |  |  |
|--|--|
| A. More People Have Died in Ted Kennedy's Car Than in Nuclear Power Plants | F. What Spreads Faster Than Radiation? Jane Fonda  |
| B. More Nukes—Less Kooks   | G. Nuclear Plants, Not Marijuana Plants            |
| C. Kuow Nukes  | H. Nuclear Plants Are Built Better Than Jane Fonda |
| D. Don't Let Jane Fonda Pull Down Your Plants                              | I. Warning: I Don't Brake for Liberals             |
| E. Chappaquidick 1, Three Mile Island 0, Go Nuclear                        | J. President Carter Kiss My Gas                    |

\$1.00 each; 25 for \$15; 100 for \$35

Inquire about custom stickers with your company logo.

**Campaigner Sticker**, Department F, 52 N. Arlington Ave., East Orange, N.J. 07017. Master Charge and Visa cards accepted.

## Presidential Energy Scorecard

# How the Candidates Measure Up

There are no surprises in the energy planks of the Democratic and Republican presidential candidates. As expected, both platforms share the goal of cutting back U.S. dependence on foreign oil and an emphasis on conservation. There is a big difference, however, in the policy on synthetic fuels and nuclear power. In brief, the Republicans want synthetic fuel development along with nuclear power, while the Democrats want synfuels without nuclear power.

Both platforms feature a potpourri of "alternative energy sources" in which is included mention of nuclear fusion. The Democratic platform, however adds: "The Democratic Party vigorously supports substantial funding for the construction of an engineering test facility for fusion technology. Fusion energy is a safe, clean alternative source of energy which can be used to generate electricity efficiently."

The basic questions to be answered in both cases are: First, will energy and capital investments centered on synfuels cure or intensify the domestic depression? In particular, how will the West spare the vast amounts of water needed for synfuels?

Second, are coal exports, assuming this becomes reality, a viable basis for foreign policy and Third World development?

The campaign staff of independent candidate John Anderson was unable to provide *Fusion* with an official statement on energy policy, but Jack Christie, a congressional aide to Anderson, told *Fusion* that the candidate remains "very cautious" on nuclear energy since Three Mile Island and opposes the issuing of licenses for any

new nuclear facilities until the safety and other provisions of the Kemeny Commission report are implemented. Anderson is also "sticking to" his earlier call for a 50 cents a gallon gasoline tax to enforce conservation.

### The Republicans

Reflecting the progrowth, conservative constituencies supporting the Reagan candidacy, the Republicans came out with an endorsement of nuclear energy and expanded fossil fuel production. As a whole, however, the Republican platform's energy plank equally embraces costly synthetic fuels, so-called renewable resources, and conservation measures.

The overall package is shaped by the goal of achieving "energy self-sufficiency" in the United States—although this clearly entails reduced energy consumption and economic growth. Here's what the Republican platform specifies:

*Self-sufficiency.* The U.S. government should resume filling the nation's strategic petroleum reserves at once to planned levels of 500 million barrels in the short term and to 1 billion barrel levels in the long term.

*Nuclear.* "We support accelerated use of nuclear energy through technologies that have been proven efficient and safe. . . . We believe that the licensing process can and should be streamlined through consolidation of the present process and the use of standardized reactor designs.

"The Three Mile Island incident suggests the need for certain reforms, such as in the area of operator training, but illustrates that properly designed and operated nuclear plants do not endanger public health or safety. We further encourage the re-

search, development, and demonstration of the breeder reactor with its potential for safely contributing to our nation's future energy supplies.

"Nuclear power development requires sound plans for nuclear waste disposal and storage and reprocessing of spent fuel. Technical solutions to these problems exist, and decisive federal action to choose and implement solutions is essential."

*Coal.* The Republicans emphasize that coal "can bridge the gap between our other present energy sources and the renewable energy sources of the future." These are defined as "solar energy, geothermal, wind, nuclear fusion, alcohol synthesis, and biomass."

The platform calls for a program of regulatory reform and incentives to speed conversion of "utility, industrial and large commercial oil-burning boilers to coal to the greatest extent feasible, thus substantially cutting our dependence on foreign oil."

To fully utilize the nation's coal resources, the Republicans advocate the upgrading and decontrol of coal transportation systems.

### The Democrats

Conforming with President Carter's known opposition to nuclear energy, the Democratic platform's energy plank rules out the licensing of any new nuclear plants in the United States until the environmentalist lobby's last objection is answered, and the platform plans the "retirement" of nuclear power in favor of alternative fuels. The two themes of the plank are conservation and the development of synthetic and renewable resources.

*Conservation.* "We must make energy conservation our highest prior-

## National

ity... If we can convince one of every four drivers exceeding the 55 mile per hour speed limit to reduce their speed, we can save 100,000 barrels a day. Conservation is the cheapest form of energy production."

The platform advocates "a massive residential energy conservation grant program" for making all residences "energy efficient."

The Democrats call for resumed filling of the strategic petroleum reserve and a stand-by gasoline rationing plan for use "in the event of a serious supply interruption."

*Alternative Sources.* "Major new efforts must be launched to develop synthetic and alternative renewable energy sources." The platform lists increased coal use, biomass, fusion, geopressure, cogeneration, geothermal, wind, and hydro power.

*Nuclear Fission.* "Through the federal government's commitment to renewable energy sources and energy efficiency, and as alternative fuels become available in the future, we will retire nuclear power plants in an orderly manner... The NRC [Nuclear Regulatory Commission] shall issue no licenses or permits for new nuclear plants until the Kemeny Commission recommendations are fully implemented."

## Puget Power Restricts New Customers

Puget Sound Power and Light in Seattle became the first U.S. public utility to restrict future customer use because of projected capacity shortage. The utility announced in July that it would not accept any new large commercial or industrial electrical customers as of Aug. 1 for fear that it will not be able to meet reliable service standards.

Puget Power vice president R.H. Swartzell, writing in the Aug. 4 issue of *Energy User News*, stated that the utility may not be able to meet existing requirements because of delays in construction of new electric-generating capacity.

## Calif. Mandates Energy Cutbacks

The California Energy Commission is presenting the state legislature with an energy plan that mandates a 20 percent cut in energy use in the industrial, commercial, and agricultural sectors by 1985, based on 1979 consumption levels.

Known as the Mello Report, the plan calls for a mandatory cutoff of utility service to commercial and industrial firms that do not cut their energy use 20 percent by 1983. The plan is named after State Assemblyman Henry J. Mello whose 1978 bill required the Energy Commission to come up with a plan to cut energy use 20 percent.

Under the Mello Report, utilities would be responsible for identifying commercial customers that exceed their "energy budget." The "energy budget" for each business would be determined by the Energy Commission staff "for each of the 11 major

commercial building types described in the Commission's load management standards and an index should provide a common method for measuring total use of all facilities in a class."

Staff members of the California Energy Commission said that the plan is now being revised but that the provisions for a 20 percent usage reduction will remain because they are mandated by law. Assembly bill 3539, sponsored by Mello, was enacted into law in September of 1978 and directed the California Energy Commission to develop a program to achieve the 20 percent cut in the nonresidential sector by 1985.

The Mello Report calls for the licensing of persons to perform the energy surveys carried out by the utilities. Those "Energy Professionals," states the report, "with no specific requirement of registered engineer status... should be authorized to self-register themselves as 'Registered Energy Managers' who are bound to uphold the professional energy management code of ethic." The code will be developed by the Energy Commission Task Force.

How does the Energy Commission intend to get the utilities to go along with all this? In its introduction, the Mello Report calls for "transforming utilities into 'Energy Service Corporations,' " whose services include policing the use of "energy-conserving technologies."

### Cutting Agriculture

The Mello Report states unequivocally that the 20 percent cut in use of energy applies to the agricultural sector, California's leading industry, and calls for "tax incentives for agricultural sectors to implement the conservation and alternative energy programs." In its agricultural energy use section, the report points out that "those in agriculture may have the most critical need for options which reduce energy intensity." There is no mention of how California's energy-intensive, highly productive agricultural sector is to continue producing food with reduced energy inputs.

—Mary Gilbertson



# Iraq to Use Nuclear Technology To 'Fertilize the Desert'

In an official statement issued at the end of July, the government of Iraq announced that it is now assured of receiving French nuclear technology, which it intends to use to "fertilize the desert," bringing about "permanent climatic and agricultural changes" throughout the Arab world.

The communiqué stated that the joint program will train a corps of scientists from Arab nations and that the "desalination of seawater" and other nuclear-based technologies will enable the people of the Middle East to "increase and diversify agricultural production" and build modern industries.

### The Proliferation Specter

Since France announced that it would sell Iraq a nuclear power research facility, there has been opposition to the plan. As in the case of other developing nations like India, the specter raised has been weapons proliferation; the specific charge here is that France may be giving Iraq weapons-grade nuclear material and that Iraq's nuclear capacity will change the balance of power in the Mideast.

French President Giscard d'Estaing, however, has ignored the advice from Washington and London and pushed the Iraq sale through, noting that Baghdad is a signatory of the nuclear nonproliferation treaty.

As an indication of just how embattled the issue of nuclear development is, in April 1979, saboteurs bombed two nuclear reactor cores in France that were to be sent to Iraq. Later, an official of the Israeli intelligence agency, the Mossad, claimed credit for the raid.

### Transforming the Desert

"Iraq intends to utilize nuclear energy in particular to fertilize its western desert, a vast arid area near Syria, Jordan and Saudi Arabia," wrote France's *Les Echos* newspaper July 29,

citing the official Iraqi News Agency (INA):

"The transformation of this region will have important climatic and agricultural repercussions and will serve as a model for similar experiences in other parts of the Arab world, which possess the largest deserts in the world. . . . The agency underscores the fact that these transformations should contribute to resolving numerous demographic, economic, and social problems.

"Iraq intends as well to make use of nuclear energy to ameliorate, diversify, and expand its agricultural production and desalinate the water. It intends besides to make use of nuclear energy in medicine, INA reports."

Another source, the *Middle East Economic Digest*, reported, "The 1980s are likely to witness a major emphasis on irrigation and land reclamation, in line with President Saddam Hussein's slogan: 'Agriculture is permanent oil.'"

In 1975, Iraq signed two accords to cooperate on nuclear development, one with the Soviet Union and one with France. The much-contested accord for a nuclear power research facility was signed with France in September 1976. The center is to be operational by 1981-82, is to be equipped with two reactors totaling 70 megawatts, and employ approximately 600 engineers and technicians in training programs at any one time. At present, 600 Iraqi scientists are already undergoing training in France and elsewhere.

The manpower trained at the new facility inside Iraq will include many non-Iraqis. The official statements emphasize that an aim of the program is the training of a scientific elite throughout the Arab world.

The Iraqi plan for developing the Middle East using nuclear power is

similar in scale to the program presented by the Fusion Energy Foundation at its January 1978 international Conference on Middle East Peace and Economic Development, held in New York City and attended by 300 persons. The FEF program proposed the use of nuplexes—agroindustrial complexes centered around one or more nuclear plants—for large-scale desalination projects as well as energy for industry. The FEF also proposed that the skilled workforce of Israel and Egypt train and upgrade the rest of the region's manpower to make the entire area an industrial and agricultural oasis.

## Bardwell Addresses Pemex Seminar on Mexican Economy

More than 40 engineers, mathematicians, and physicists in Mexico City attended a day-long presentation July 24 by Dr. Steven Bardwell, who previewed a detailed development program for the Mexican economy now in preparation by the Fusion Energy Foundation and the weekly *Executive Intelligence Review*. Bardwell, FEF director of plasma physics, is one of the research team that developed the LaRouche-Riemann economic model used in the Mexico program.

The Bardwell presentation was part of a five-day seminar on "econometric" modeling tools sponsored by the Mexican Petroleum Institute, the research unit of Mexico's state-owned petroleum company, Pemex.

The audience, mostly engineers, was most interested in the difference between Bardwell's approach, which treats an economy as a thermodynamic system, and the abstract monetary categories employed by other econometric speakers, who seemed barely able to relate their work to industrial development.

"We have felt the need to have our students study economics," reported

one institute engineer afterward, "but we've been very unhappy with the way economics is taught." Bardwell was asked to advise them on developing their own curriculum in the field.

Bardwell's talk ranged from the present state of the U.S. economy to a development program for India prepared with the LaRouche-Riemann model.

### Mexican Development

Supporting the industrialization thrust of the Lopez Portillo government, Bardwell asserted the need for improvement in Mexico's approach in two critical areas: nuclear power, whose development has tended to be overshadowed rather than accelerated by vast oil reserves, and agriculture, where a serious problem of backwardness imposes a drag on the entire economy.

"Contrary to common sense," he stated, "the heaviest investment must be concentrated in those areas that are richest, not poorest—that is, in capital-intensive agricultural sectors capable of generating maximum reinvestable surplus per margin of initial investment. One must not ignore the needs of the poor; one must also not conduct investment policy so as to preserve subsistence agriculture and poverty. Both must be phased out."

In discussing Mexican development needs, Bardwell used the example of India, where an EIR-FEF program emphasized crash high-technology development projects over a 40-period. "The Indian government invested heavily in nuclear energy as a basis for upgrading the entire economy to provide sufficient energy for an industrial infrastructure's development," he stated. "Mexico must do the same."

### Nuclear Energy Key

"You identify nuclear power as the key strategic investment for India," stated an engineer. "But we have oil; do we need nuclear power?"

Bardwell replied, "Yes, for two reasons: Mexico does not need nuclear power so much for energy as for education and defense. Mexico must

use its oil as the basis for expanding industrial infrastructure. But the key to manpower development is nuclear energy. Rates of industrial development will increase in proportion to declines in energy costs, provided those declines are a result of energy-intensive technology's application for improved productivity."

Second, Bardwell emphasized, a growing nuclear industry is politically essential to strengthen the nation against pressures from forces opposing Mexican industrialization. "The most powerful way for a nation like Mexico to defend its threatened national sovereignty and assert independence of the World Bank and other Malthusian agencies is to develop a nuclear industry."

"Consider France," Bardwell said. "France is a great and sovereign nation today, with powerful influence for good in a crisis-wracked world, because 20 years ago it embarked on a strong nuclear program, maintaining and strengthening that commitment despite all contrary pressures. Today, it is capable of its own foreign policy, and its own international as well as national economic programs."

## Japan to Build 4 Nuclear Plants

Japan's Nuclear Safety Commission gave the go ahead in July for the construction of four new nuclear power plants with a total electric capacity of 3,600 megawatts (MW). These are the first plants approved since the Three Mile Island incident last April.

The administration of Masayoshi Ohira (now deceased) had ordered a moratorium on nuclear plant construction after TMI, but the new government of Prime Minister Zenko Suzuki is "manifesting an extremely positive stand on construction of nuclear power plants," according to the Aug. 5 issue of Japan's business daily *Nihon Keizai Shimbun*.

Tokyo Electric Power, the world's

largest private electric utility, will construct two of the plants, each with a capacity of 1,000 MW. Spokesmen for the company noted, however, that this construction barely keeps up with their needs since, to meet customer demand, they must increase their capacity by approximately 2,500 MW each year. This would mean at least two 1,000-MW plant starts per year, preferably nuclear.

Kansai Electric Power, Japan's second largest utility, will construct the other two new plants, each with a capacity of 800 MW.

### Doubling Energy Consumption

Japan's Ministry of International Trade and Industry (MITI) plans to solve Japan's energy problems between now and 1995 by lowering the percentage of imported oil from the current 75 percent to 45 percent of its power supply, while doubling energy consumption.

Increased imports of liquid natural gas and an ambitious nuclear program will make up the difference, with nuclear-supplied energy increasing from the present level of 8,000 MW (about 2 percent of total energy consumption) to 78,000 MW in 1995; that is, 14 percent of total energy consumption and 30 percent of electricity will be supplied by nuclear energy, with four or five 1,000-MW nuclear plants completed each year.

The Japanese nuclear program also includes uranium-enriching and reprocessing facilities, to give Japan independence in its energy needs. The government's Power Reactor and Nuclear Fuel Development Corporation has announced that a pilot fuel-enrichment plant will be completed by the end of 1981, with a 30-gigawatt enriching capacity.

At present Japan is entirely dependent upon the U.S. Department of Energy and France's Eurodif for enriched uranium. The Carter administration has threatened cutoff of enriched uranium to Japan whenever Japan has gone against U.S. policy in the nuclear area (for example, when Japan initiated the processing plant at Tokai-mura).

## Electromagnetic Water Treatment A Technological Breakthrough?

The Fusion Energy Foundation engineering staff has begun an investigation of the scientific principles of electromagnetic water treatment, a process in use for some time in the Soviet Union and more recently—but on a very limited scale—in American commercial applications.

The process aims to prevent the precipitation of carbonate and mineral "scale" in water and heat exchanger pipes, using electromagnetic fields rather than chemicals. Potentially it holds great promise for irrigation and desalination systems, water analysis and treatment, and commercial "descaling" applications in the power industry.

The long-accepted descaling method—using chemicals to remove the impurities in some new chemical compound form in filters or resins—imposes large costs and down time on the power industry each year.

Soviet use of electromagnetic water treatment, which goes back more than two decades, has been the subject of several scientific papers published in the Soviet Union as well as a review paper prepared by Informatix, Inc. for the U.S. Air Force Office of Scientific Research. Soviet use involves the simple application of an electromagnetic field to flowing water to increase its solubility and thereby reduce precipitation.

The Soviet literature admits ignorance about how the process works, and a research program is in progress to try to solve the problem. Scientists are currently trying to determine whether the magnetic field affects the structure of the water itself or acts primarily on the suspension or solute.

However, the Soviet literature

leaves no question that the process works. It is used for elimination of scale caused by high temperature, control of encrustation on equipment, reduction of salt deposits, intensification of crystallization, purification or recycling of waste water, and faster solidification of certain cements.

### Improvement Added

The Miami-based Turbomag Corporation, which has studied the Soviet process, has improved it by an added element—the use of an impeller to produce a rotary or spiral flow within the water to which the electromagnetic field is applied. Under this condition the magnetic treatment produces a change in the water causing a change in the physical-chemical characteristics of the impurities.

Specifically, calcium chloride normally plates out on heat exchanger tubes as a very hard scale that drastically reduces heat transfer efficiency. After magnetic treatment the calcium chloride does not scale but settles out of solution as an easily removable sludge.

Perhaps most interesting scientifically is the analogy to the electromagnetic analysis of cell water in human tissue, used as a method for early cancer detection known as FONAR and described in *Fusion* in July 1978. Magnetic treatment evidently changes the extended structure of water molecules, which depends on hydrogen-bonding changes and is not chemically analyzable. The more rapidly the process is mastered scientifically, the broader the potential benefits to agriculture, industry, and medical-biological practice.

—Jon Gilbertson

# the Campaigner

## The Racist Roots of Jazz

September

## Why The British Hate Shakespeare

October

Please enter my subscription to *Campaigner* for  
**1 year \$24.00**

I enclose \$ \_\_\_\_\_ check or money order.

Name \_\_\_\_\_

Address \_\_\_\_\_

City/State \_\_\_\_\_ Zip \_\_\_\_\_

Telephone (\_\_\_\_) \_\_\_\_\_

Make checks payable to Campaigner Publications,  
304 W. 58 Street, New York, NY 10019.

FUM-4

# the Campaigner





# HACER:

## A Grand Design for Fusion Power

by Dr. Walter Seifritz

In the 1950s, after development of the H-bomb, U.S. researchers developed a project known as Pacer, aimed at peaceful applications of nuclear explosions. The H-bomb, of course, is the "uncontrolled" release of fusion energy using a relatively small fission (A-bomb) trigger. What the Pacer project envisioned was the regular detonation of H-bombs in carefully designed, steam-filled caverns one mile underground, producing enormous amounts of electricity and fissile material.

Most appealing about this approach is that there are only minor scientific and technical obstacles to the realization of a Pacer-like system for harnessing fusion energy; it could be undertaken immediately, on the basis of

existing technology and know-how, guaranteeing commercial fusion power before the end of the century.

Environmental and "nonproliferation" arguments were introduced to force discontinuation of the Pacer project. These arguments, however, lacked validity. But rather than answer them, I would like to propose the revival of the Pacer project in connection with a second, often-heard proposal—that of an "energy island" or "energy mountain," a remotely located energy community, against which no credible argument about alleged nuclear hazards to populated areas of the globe could be raised.

Recently, writing in a German journal (Ronen 1979), Y. Ronen took a new look at the original proposal of C. Marchetti to establish such an energy island (Marchetti 1975). In the Ronen version, a "nuclear community,"



Lookout Mountain Air Force Station

the so-called energy mountain, has also been proposed (Huwyler and Seifritz 1976), referring explicitly to the possibility of producing energy at a given time and place and consuming it at another time and place. In all these proposals, it is important to emphasize that this possibility is more promising with hydrogen as a secondary energy carrier, rather than with electricity; in other words, hydrogen could be made "the long arm" of nuclear energy.

Heretofore, such proposals have been based purely on fission energy. The proposed energy centers feature a symbiosis between breeders that breed mainly surplus fissile material and advanced thermal converters, preferably near-breeder, high-temperature reactors that produce mainly hydrogen either by thermolysis or advanced electrolysis. The idea is to restrict sensitive parts (breeders, fuel element fabrication, reprocessing, and waste disposal) to localized energy or fuel-cycle centers. Coupled uranium and thorium fuel cycles (Seifritz 1978) could provide an abundant primary energy source for centuries.

However, one disadvantage of centers based on pure fission energy is that they produce relatively large amounts of waste heat compared with the usable energy in the form of electricity or hydrogen, on the one hand, and fissile material, on the other. If the Pacer fusion system, or some modified version of Pacer, were the core of such a center, however, that disadvantage would be overcome.

#### Measuring Energy Performance

To measure the energy and waste heat produced in each situation, I shall use two "free-energy-enhancing" performance indexes,  $N_1$  and  $N_2$ , to express the quality of the nuclear energy produced by different systems. The first,  $N_1$ , is defined as the ratio of the total usable energy produced to the waste energy released to the environment on site:

$$N_1 = \frac{\text{total usable energy produced}}{\text{waste energy released}} \quad (1)$$

$$= \frac{E_{\text{dir}} + E_{\text{ind}}}{E_{\text{waste}}}$$

where  $E_{\text{dir}}$  is the electricity produced,  $E_{\text{ind}}$  the thermal energy content of the bred fissile material (1 gram of fissile material bred corresponds to 1 megawatt-day, that is, MWd), and  $E_{\text{waste}}$  the waste heat released to the environment.

The higher  $N_1$  is, the more usable energy is produced with respect to the waste heat released; that is, the higher is the free energy content of the energy produced.

The accompanying table lists  $N_1$  for various nuclear energy systems. The pure fission systems, the light water reactor and fast breeder reactor, are compared to a mixed fission-fusion system such as Pacer.

Because of the "energy poorness" and "neutron richness" of fusion, particularly in the case of Pacer's deuterium-deuterium fusion—a high-temperature process in which two deuterons, rather than a deuteron and a triton, for example, are fused—the free-energy-enhancing per-

## in This Century

perhaps under auspices of the European Community in treaty with other national and international bodies, could be established to operate large power reactors producing hydrogen. The hydrogen could be transported as a pipeline gas, or preferably as a liquid in tankers.

Easily storable and transportable, hydrogen allows for the spatial and temporal transfer of large quantities of energy. "No man's land" such as Antarctica or uninhabited islands in the ocean where plenty of cooling water is available have been proposed as possible sites. In this case, no one could block the progress of this energy-production plan by pointing to alleged ecological hazards to populated areas of the globe or the alleged hazards of proliferation of nuclear weapons.

A land-based equivalent of the sea-based energy islands,

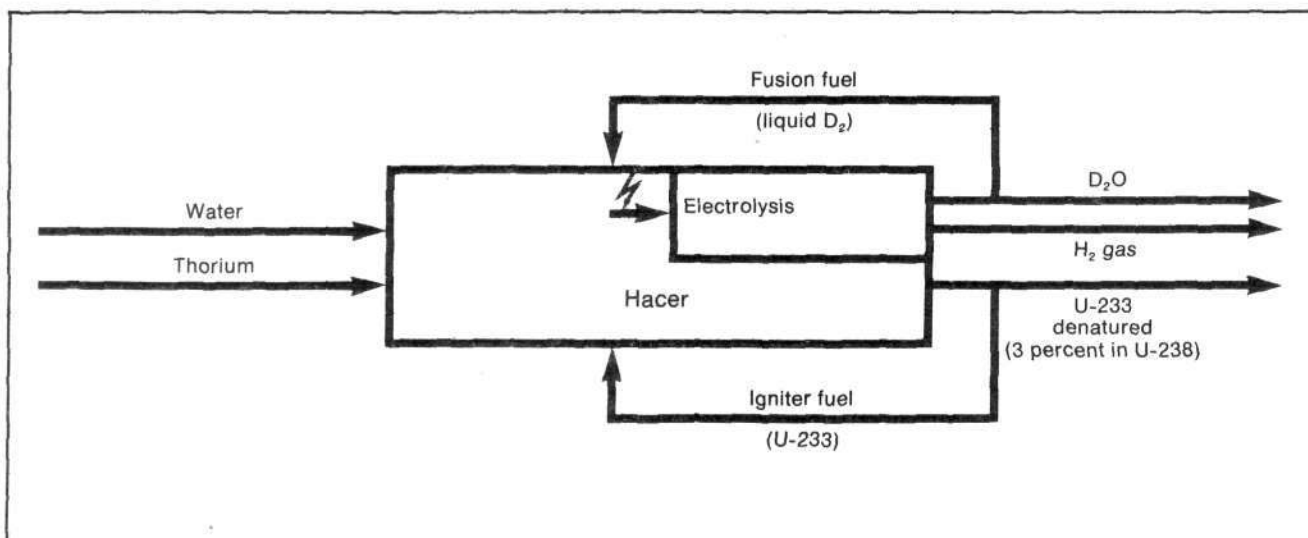

**Figure 1**  
**BLOCK DIAGRAM OF HACER**

The hydrogen and U-233 fuel-producing system Hacer uses water and thorium as fuel and feedstock material, respectively. It produces (a) hydrogen pipeline gas; (b) denatured U-233 in the form of approximately 3 percent enriched LWR-fuel (or the U-233 can be mixed with thorium oxide, approximately 3 to 4 percent, to yield a purely thorium-based LWR fuel without any natural uranium supply); and (c) heavy water as a by-product.

formance index  $N_1$  is approximately an order of magnitude higher than it is with pure fission systems. Pacer can be used to breed fissile materials like plutonium or very pure uranium-233 (without any U-232 contamination). These can be used to fuel a large number of light water reactors, for example, which are scattered in various countries.

In fact, the DD-fusion/fission Pacer system produces the "most noble" form of nuclear energy because only a relatively small part of the energy produced has to be released to the environment. The overwhelming majority of the energy produced is bred fissile material—a potential or stored energy that can be moved easily in space and time in highly energy-dense form.

Hybrid fission-fusion systems based on magnetically or inertially confined deuterium-tritium plasmas with fertile blankets have been frequently proposed as an energy source of this kind (Schoonover 1979, Stevens 1980). However, these systems are not yet developed and must continue to be the focus of scientific work. Pacer not only has a better performance index, but also can be introduced now, using existing technology.

#### Portable Energy

The second performance index,  $N_2$ , of a nuclear energy-producing system is defined as

$$N_2 = \frac{\text{energy produced as bred fissile fuel}}{\text{energy produced as electricity}} \quad (2)$$

$$= \frac{E_{\text{ind}}}{E_{\text{dir}}}$$

where, again,  $E_{\text{ind}}$  is the thermal energy content of the bred fissile material and  $E_{\text{dir}}$  is the electrical energy produced.

$N_2$  is a specific quality factor for a remote site where it is especially difficult to dispose of the energy produced. A higher  $N_2$  means that more bred fuel, which is easily transportable, is produced with respect to electricity, which is not easily transportable. The table shows that hybrid DD-fusion/fission systems exhibit an extremely high  $N_2$  value. This means that an ideal power plant located on a remote site should produce only bred fissile material. In that case no real transportation problem occurs and, consequently, the remoteness of the site is no severe drawback.

It should be pointed out that the immediate and direct conversion of the electricity into hydrogen gas by electrolytic means would facilitate transportation further. Beyond a distance of 300 to 500 kilometers it is preferable to transport hydrogen gas in a pipeline rather than electricity by high-voltage transmission lines.

Taking all these considerations into account, the hybrid Pacer system, based on DD-fusion, exhibits the most favorable features for a remote-site power station.

#### The Explosive DD-Fusion Process

The explosive fusion process was first accomplished in 1952 using the Teller-Ulam idea of igniting a relatively large amount of fusion material with a relatively small fission trigger (called "Super"). With our presently more sophisticated understanding of underground explosions—mainly the so-called decoupling that prevents seismic



**COMPARISON OF FREE-ENERGY-ENHANCING  
PERFORMANCE INDEXES FOR  
VARIOUS NUCLEAR ENERGY SYSTEMS**

Nuclear reactor type	Free-energy-enhancing performance indexes	
	$N_1 = \frac{E_{dir} + E_{ind}}{E_{Waste}}$	$N_2 = \frac{E_{ind}}{E_{dir}}$
<i>Pure fission reactors</i>		
Light water reactor (typical PWP, $\eta = 33$ percent, 170 kg Pu <sub>fiss</sub> /yr)	0.73	0.47
Liquid metal fast breeder reactor (typical LMFBR, $\eta = 40$ percent, 250 kg Pu <sub>fiss</sub> /yr)	1.12	0.68
<i>Fission/fusion systems</i>		
DT-Hybrid reactor (Self-sustained in T-production, $\eta \sim 30$ percent, 0.88 kg fissile/MW-yr th)	3.89	7.97
DD-Hybrid Pacer ( $\eta = 33$ percent, 2.7 kg fissile/MW-yr th)	11.5	22.3

effects—we can safely contain explosive fusion energy in large combustion caverns located about 1 mile underground. I will not go into details here—they are described elsewhere (Pacer 1975, Hammond and Hubbard 1978). The main idea in harnessing DD-fusion energy is to regularly explode relatively clean liquid DD-fuel charges in the 20-kiloton TNT yield range in cavities about 200 meters in diameter, 1 mile deep. The cavities will be filled with superheated steam at a mean temperature of about 500 degrees Celsius and a pressure averaging 200 bars (Hammond and Hubbard 1978).

The steam absorbs and quenches the fireball, protects the wall by absorbing radiant energy, and acts as a transport medium to carry the thermal energy and particulate by-products (for example, precursor particles of fissile materials like U-233 if the fusion device is surrounded by a thorium blanket) to the surface in a convenient dilute form. Recovery of these mixed solids, including the fission products from the steam, can be done by collection from the condensed water before its return to the cavern.

The total stored radioactivity is less than one-thousandth that present in the core of an equivalent fission reactor because of the continuous removal system, and because the larger part of the energy release is the result of deuterium-deuterium fusion.

#### Hydrogen, Deuterium, and Fissile Fuel

Pacer's products are, therefore, electricity and fissile material, which could run a series of thermal converters in symbiosis, but not necessarily at the same site. The electricity can be transformed into hydrogen by classical

electrolysis, thereby producing deuterium as a by-product. A 1-MW<sub>e</sub> (megawatt electric) DC-electrolysis plant with a capacity of 90 percent produces 160 kilograms of deuterium oxide (D<sub>2</sub>O, 99.8 percent) per year (Haemmerli *et al.* 1979). According to another, Canadian source (Bailey), the D<sub>2</sub>O production rate using an electrolytic plant is 140 kilograms per electric megawatt-year (kg/MW<sub>e</sub>-yr). If we take a mean value of 150 kg/MW<sub>e</sub>-yr as a calculational basis, a 2,000-MW<sub>e</sub> Pacer plant possessing a load factor of 80 percent, coupled to a DC-electrolyzer, will produce approximately 48 tons of deuterium per year.

The catalyzed DD-fuel cycle (burning tritium and helium-3 *in situ*) possesses an energy content of about 14 MeV (million electron volts) per deuterium molecule burned. Thus, the 48 tons of deuterium calculated above could produce more than 500,000 MW-yr of thermal energy assuming a 100 percent burn efficiency. Since the thermal efficiency of Pacer is about 33 percent, approximately 5,000 MW-yr of thermal energy must be produced to get 2,000 MW<sub>e</sub> with a load factor of 80 percent.

Only 10 percent of the total deuterium produced has to be recycled as the essential fuel if we assume a practical burn efficiency in the fusion charges of 10 percent.

Hence, the Pacer reactor described is actually a machine that runs on water: It uses water as its fuel and as its feedstock material for the water-splitting process, simultaneously. Since the hydrogen production mode is a new feature of this system, I propose that it be called Hacer.

Figure 1 shows the basic principle of the modified Pacer system now called Hacer. It consumes water and thorium and produces large amounts of:

**Figure 2**  
**ARTIST'S CONCEPTION OF A DD-FUSION 'ENERGY PARK'**

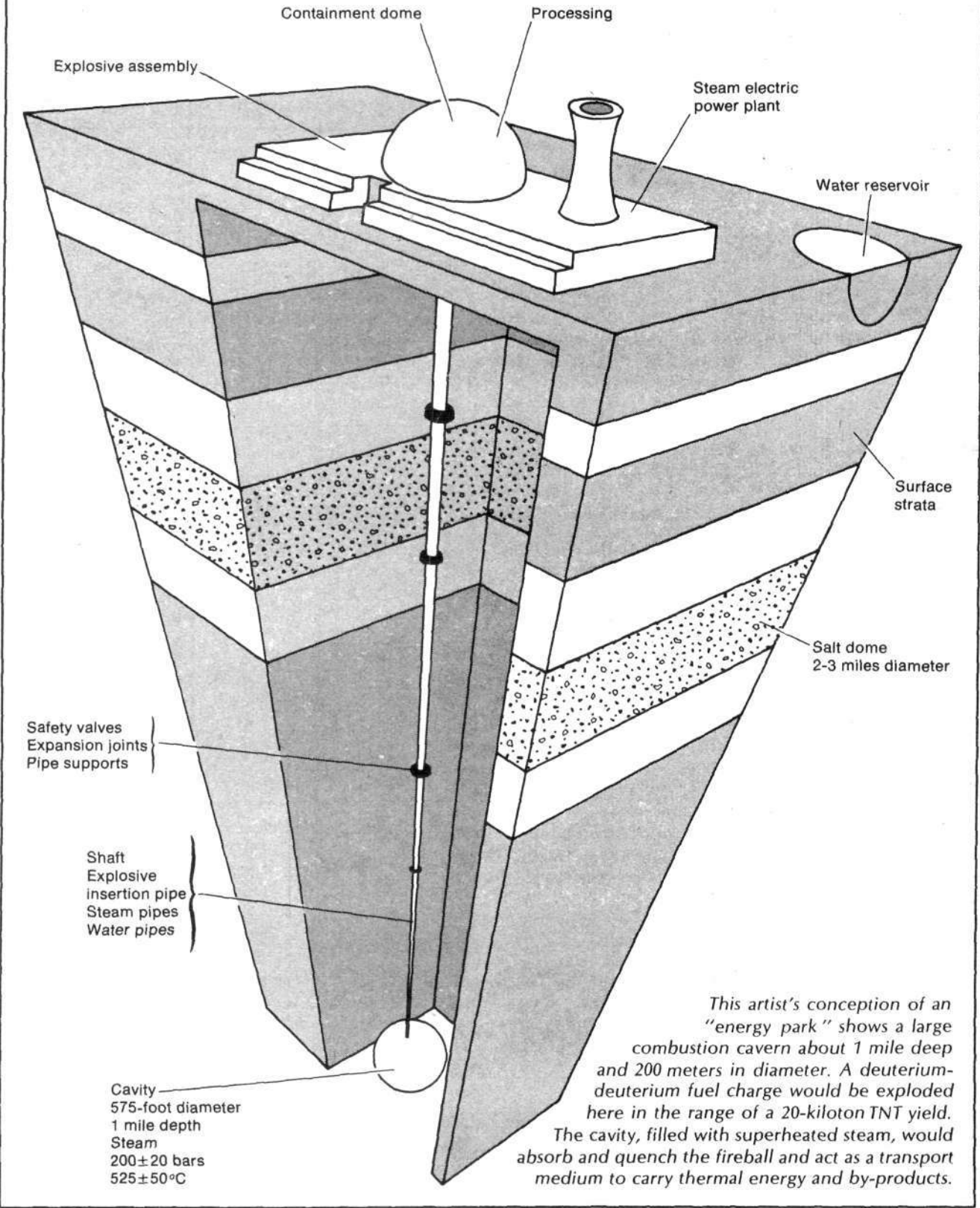

*This artist's conception of an "energy park" shows a large combustion cavern about 1 mile deep and 200 meters in diameter. A deuterium-deuterium fuel charge would be exploded here in the range of a 20-kiloton TNT yield. The cavity, filled with superheated steam, would absorb and quench the fireball and act as a transport medium to carry thermal energy and by-products.*



USIS

In 1957, the Plowshare program for the peaceful application of nuclear explosions began to experiment with large, underground explosions. The commercial applications proposed were excavating canals, building tunnels, harbors, and dams, and recovering natural resources. Shown here is a hook-shaped underground tunnel in the Plowshare project in which a nuclear device was detonated.

- Fissile materials in the form of very pure U-233 denatured with U-238. The U-233 can also be mixed with thorium as a substitute light water reactor fuel to eliminate any natural uranium supply problem. (Thorium oxide pellets contain about 3.5 percent U-233.)
- Hydrogen as a clean secondary energy carrier in the form of a pipeline gas.
- Heavy water as a useful by-product.

The unused  $D_2O$  could be used as a moderator and/or coolant for heavy water reactors. For example, Candu reactors operate with a specific  $D_2O$  inventory of 0.8 to 0.9 metric ton per megawatt-electric (Haemmerli *et al.* 1979). A symbiosis between Hacer-borne  $D_2O$  and Hacer U-233-fueled near-breeder Candu reactors operating on the U-233/thorium fuel cycle is also possible and would be even more effective than the already mentioned Pacer/light-water-reactor symbiosis.

In Canada, 4,000 metric tons per year of heavy water are committed (Haemmerli 1979). The production of more than 1,500 metric tons per year of deuterium oxide from 10,000-MW<sub>e</sub> electrolyzer modules with Hacer as the energy source could certainly affect this  $D_2O$  market.

Since the physics of Pacer is a fission-triggered DD-fusion reaction, a small amount of the U-233 produced

has to be recycled as the fuel for the fission igniter. Tritium and helium-3 are produced during the DD burn, with part burned *in situ* and the rest to be recycled as fusion fuel.

One would use some tritium first to ignite a small DT zone of the explosive charge, which would raise the temperature; this temperature rise would then ignite the DD detonation in the liquid deuterium itself. It is within current technology to design such devices.

For example, an 8,000-MW capacity electric power plant based on the Hacer idea could produce up to 65 tons per year of U-233, sufficient to reload more than 100 light water reactors each year. The plant would have four caverns, as described above. In each cavern, a 20-kiloton TNT-equivalent DD-Super would be exploded every 4 hours. Nearly 50 times as much fissile material will be produced, compared to an equivalent fission breeder. Therefore, the free-energy performance indexes  $N_1$  and  $N_2$  of a nuclear energy center based primarily on the neutron-rich DD-fusion process will be at least one order of magnitude higher than for a pure fission-breeder energy source. The waste heat load to the environment on the site is thus also reduced by the same order of magnitude.

### Increasing Free Energy

In a somewhat more general sense, we can define the conversion of fertile into fissile material by means of free neutrons as the production of *park free energy* (that is, energy that can be transported out of the park), although no Carnot-cycle is involved in this process (Seifritz 1979). Thus, a Hacer energy park does exhibit the feature of a highly free-energy-enhancing energy source because it is a "free neutron factory," rather than an "energy factory." Hence, the progress of harnessing DD-fusion with its abundance of free neutrons is a step forward in the direction of establishing not only an energy center but also a "free-energy-enhancement center." Hacer is the type of nuclear machine that converts nuclear energy into an energy flux with a high free-energy content: hydrogen and fissile material (see table).

The problem of public acceptance of nuclear energy may be overcome quite easily if one relocates nuclear energy production a mile deep in the earth's crust at unpopulated, remote sites. Nuclear energy systems possessing high free-energy-enhancing performance indexes  $N_1$  and  $N_2$  are well suited for this purpose because their useful energy is produced in a form that can be easily transported over long distances.

### The Proliferation Aspect

Safeguarding the manufacture and handling of thousands of fusion devices per year in a Hacer park may seem a drawback in the present proliferation-conscious world. However, the fusion fuel deuterium can be deliberately used in a cryogenic, liquid form to make the devices nontransportable and, therefore, safe from theft, were that really a threat. Furthermore, the installation of Hacer in a remote area like an ocean island or Antarctica, operated and governed by international agreement, would guarantee that no clandestine operation could be undertaken by terrorist infiltrators in the operating staff



itself. The application of the idea of "colocation" exhibits further advantages: the light water reactor fuel is refabricated, reprocessed on site, or not reprocessed at all, and the problem of waste disposal can be solved relatively easily using the old caverns after their useful lifetime.

Furthermore, I should stress the fact that in the nonproliferation treaty each party to this treaty guarantees "any peaceful applications of nuclear explosions" on a nondiscriminatory basis (United Nations 1975, Article V).

The corresponding article reads:

#### Article V

Each Party to this Treaty undertakes to take appropriate measures to ensure that, in accordance with this Treaty, under appropriate international observation and through appropriate international procedures, potential benefits from any peaceful applications of nuclear explosions will be made available to non-nuclear-weapon States Party to this Treaty on a nondiscriminatory basis and that the charge to such Parties for the explosive devices used will be as low as possible and exclude any charge for research and development. Non-nuclear-weapon States Party to the Treaty shall be able to obtain such benefits, pursuant to a special international agreement or agreements, through an appropriate international body with adequate representation of non-nuclear-weapon States. Negotiations on this subject shall commence as soon as possible after the Treaty enters into force. Non-nuclear-weapon States Party to the Treaty so desiring may also obtain such benefits pursuant to bilateral agreements. . . .

In conclusion, there should be no insurmountable obstacles to make a peaceful use of explosive devices in an energy center based on the Hacer idea.

#### Funding and Demonstration

The capital needed for such a project can be obtained by international treaty agreement. In a first phase, an experimental program should be started with a goal of demonstrating that underground caverns in various rock formations do survive a sufficiently large number of shots. At the same time the separation of fission and fusion products, bred fissile fuel, and debris from the evaporated device and the like in the steam heated in the cavern should be tested on a larger scale. Only under these conditions can the economic viability of the proposed system be demonstrated.

It is my conviction that the amount of research, development, and demonstration work for the reactor system herein described is substantially smaller than for any other nuclear reactor system based on fusion.

In the distant future, about 15 such fusion energy parks scattered all around the world, each having only about 20 gigawatts of electrical output, could meet all the energy requirements of a 30-trillion-watt, growing world in the form of hydrogen and fissile fuel—a Grand Design for the benefit of mankind.



*Dr. Seifritz is professor for reactor technology at the Swiss Federal Institute for Reactor Research in Würenlingen, Switzerland. A well-known European authority on nuclear power, Seifritz chairs the annual World Hydrogen Energy Conference. This article represents his personal views, which do not necessarily reflect those of the Swiss Federal Institute.*

#### References

- Bailey, P.S. "Activities of the Canadian Participants in the Study of Hydrogen in Canada," Centre de Recherche Noranda, 240 Boulevard Hymus, Point Claire, Quebec, H9R 195, p. 42.
- Haefele, W. 1978. "Hydrogen and the Big Energy Options," 2nd World Hydrogen Energy Conference, Zürich, August 21-24, 1978.
- Haefele, W., and W. Sassin. 1976. *Zukünftige Energieversorgung: Optionen und Strategien*, Bergbau, Rohstoffe, Energie, Bd. 14, Verlag Glückauf GmbH, Essen.
- Haemmerli, M. 1979. Personal communication.
- Haemmerli, M., et al. 1979. "Peak Power and Heavy Water Production from Nuclear Electrolytic H<sub>2</sub> and O<sub>2</sub> in Canada," *Intl. J. Hydrogen Energy* (preprint AECL-6380).
- Hammond, R.P., and H.W. Hubbard. 1978. "Practical Fusion Power," private communication.
- Huwylar, H., and W. Seifritz. 1976. "A Symbiotic Nuclear Park as the Ultimate Primary Energy Source for Switzerland—Genesis and Rationale," 1st World Hydrogen Energy Conference, March 1-3, 1976, Miami Beach, Fla. EIR Report 291, EIR Würenlingen.
- Maniscalco, J.A., and L.F. Hansen. 1978a. "New Initiatives in Laser Driven Fusion-Fission Energy Systems," Lawrence Livermore Laboratory preprint UCRL-81509.
- Maniscalco, J.A., and L.F. Hansen. 1978b. "Present Status of Laser Driven Fusion-Fission Energy Systems," Lawrence Livermore Laboratory preprint UCRL-81510.
- Marchetti, C. 1975. "Geoengineering and the Energy Island," Second Status Report of the IIASA Project on Energy Systems, RR-76-1.
- Pacer Program. 1975. LA-5764-MS, informal report, Los Alamos, January 1975.
- Ronen, Y. 1979. "Hydrogen Economy and Nuclear Energy," *Atomkernenergie Kerntechnik*, Bd. 33, Lfg. 2, p. 144.
- Schoonover, J. 1979. "The Fusion-Fission Hybrid—Fuel Factory for Nuclear Power," *Fusion*, Vol. 2, No. 4 (January 1979), p. 18.
- Seifritz, W. 1978. Opening address to the 2nd World Energy Hydrogen Conference, August 21-24, 1978, Zurich, Switzerland.
- Seifritz, W. 1979. "Das PACER Projekt, Stichworte zu einem Kolloquiumsvortrag gehalten am 29." EIR Würenlingen, März 1979.
- Stevens, C.B. 1980. "A Review of the Livermore Report: Secrecy Blocks Laser Fusion Progress," *Fusion*, Vol. 3, No. 8 (May 1980), p. 25.
- United Nations. 1975. "Treaty on the Non-Proliferation of Nuclear Weapons," United Nations Office of Public Information, New York, OPI-324-75-38589, April.



# Science Versus Scarcity

*High-Technology Agriculture  
Can Feed the World*

## **Agriculture and Science**

- 30 The Thermodynamics of Agriculture:  
How to Feed the Whole World
- 44 The Frontiers of Agricultural Science:  
Making Shock Waves in Productivity
- 52 The Great Pesticide Hoax
- 57 Doing Something About the Weather  
*The Role of Plasma Physics in Climatology*  
*How Weather Systems Work*

## **Agriculture in Crisis**

- 61 Drought, U.S. Economic Policy Menace Farm Sector
- 64 Millions May Die in African Famine
- 66 We Need a National Water Plan Now

## **Solving the Problem**

- 70 Bringing U.S. Productivity to Mexico:  
A Firsthand Report
- 76 Parity: The Key to U.S. Agricultural Economics



# Agriculture and Science

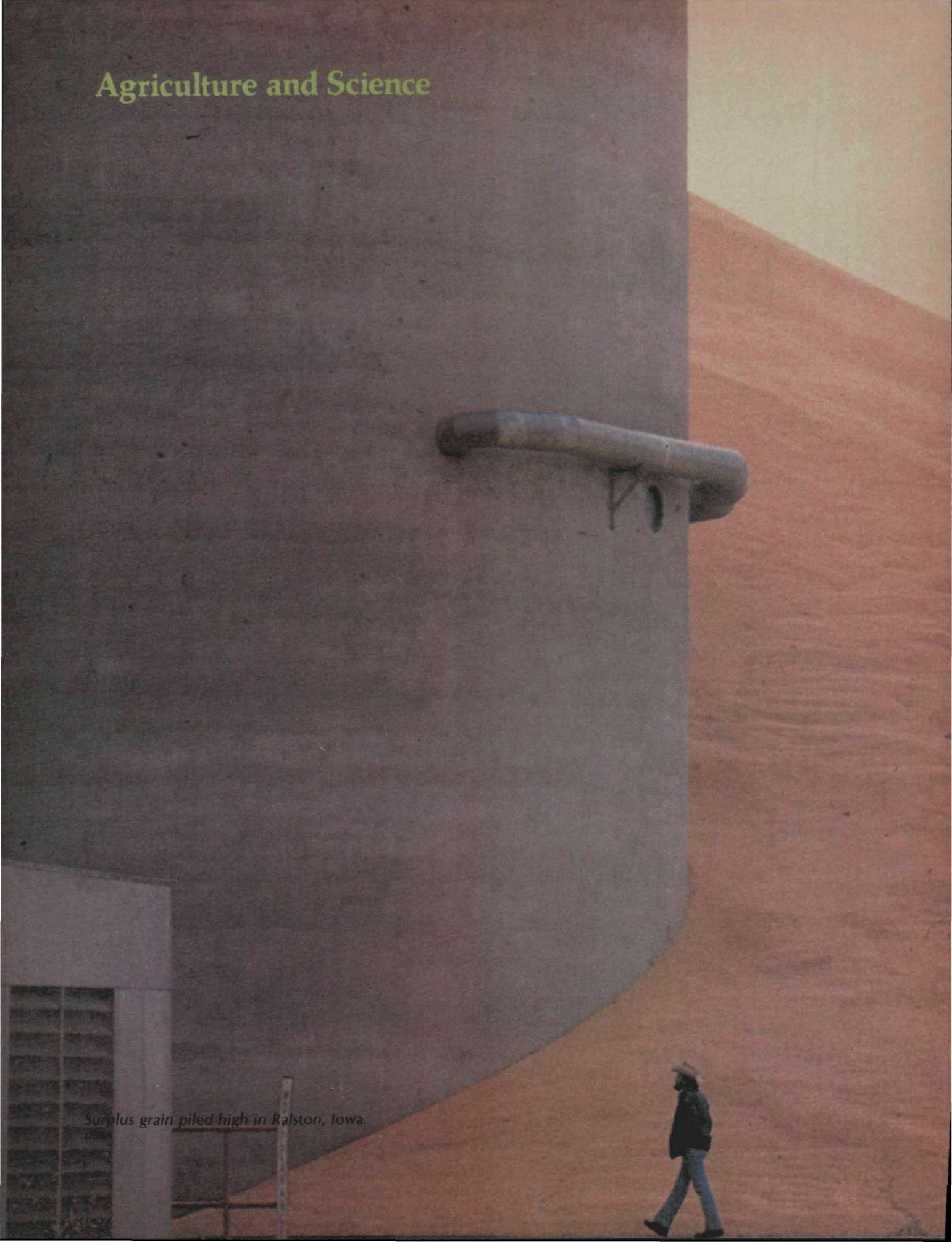

*Surplus grain piled high in Ralston, Iowa.*



# The Thermodynamics Of Agriculture

## *How to Feed the Whole World*

by Calvin Larson

**U**nderstanding the science of agriculture is no academic matter. Once understood, the scientific principles involved not only will make it possible to give the growing world population an adequate diet in the next two decades, but also will expose, once and for all, the Malthusian argument as the pseudoscience it is.

Since the time of Benjamin Franklin and Alexander Hamilton, the history of American agriculture has been one of continually increasing crop and livestock yields per area and per animal unit. Such increased production densities have been the direct outcome of successively higher-level improvements in agricultural inputs—mechanization, agricultural chemicals, land and biological engineering—and a parallel increase in energy throughput for the agricultural sector.

The most dramatic expression of this continual increase in production densities has been the steady improvement in farm labor productivity: In 1910, each worker employed directly in farm labor produced the food requirements of 8 persons; since about 1965, the American farm worker has supplied the food requirements of 65 persons—plus 15 percent of total U.S. exports. No other sector of the American economy can boast a similar record on productivity improvement.

The remarkable achievement of American agriculture is the result of the application of the science of agriculture. The Malthusians—the antiscience, “limits to growth” people—have no competent arguments to counter the historical evidence of rapid progress in agricultural methods, output, and per area yields.

The fundamental principle of the science of agriculture that underlies successful agricultural development is the lawful increase in the efficiency of energy use derived from increasing energy flux density in agricultural production—the overall energy throughput per time per area—and an increase in the free-energy ratio in agriculture.

*‘The key to the economic effectiveness of capital-intensive U.S. agriculture is the net surplus energy generated that is available for reinvestment.’*

There are three interconnected expressions for energy in thermodynamic terms. The first expression is the total number of calories-equivalent involved in the process. The second, higher-order consideration is the energy flux density of the energy throughput—the rate of calories-equivalent through a square centimeter cross section of the energy-producing and energy-consuming processes, respectively. The still higher-order and most important aspect of the energy process is called the free-energy ratio. This is the ratio of the portion of energy doing useful work to the total energy throughput.

In American agriculture, a mutually enhancing combination of increasing energy throughput and successively higher-level technological inputs has been the basis for continual increases in both energy flux density and the free-energy ratio. The history of U.S. crop and livestock production dramatically demonstrates the resulting increase in energy efficiency.

To take a graphic example of this process, Figure 1 shows the energy budget for average annual U.S. field corn production per unit of harvested area, for the period 1910 to 1980. The estimated total annual energy input comprises both operating energy requirements (human and animal labor, fuels, chemicals, seeds, and transportation) and capital energy requirements (inputs in producing tractors, machinery, irrigation equipment), amortized on the basis of useful service life.

The total energy input per unit area remains nearly constant between 1910 and 1945. After 1945, this energy input grew as a result of the increasingly intensive use of



fertilizers and mechanization. The estimated total annual energy output is based on the energy content of the average annual corn yield.

The important relationship between output and input energy is not simply the absolute ratio between the two quantities in any given year, which is used in comparisons by most analysts—although this is useful in comparing the static thermal relationships between different modes of production at a given point of time.

The key to the economic effectiveness of capital-intensive U.S. agriculture is the thermodynamics of the time rate of change of the difference between output and input energy—or the increase in the net surplus energy generated that is available for reinvestment. The rate of generation of such surplus energy, or free energy, is a true measure of the success or failure of capital-intensive scientific agricultural methods. This can be seen in Figures 1 and 2, where the increase in surplus energy can be compared to the decreasing man-hours required to feed a growing number of persons.

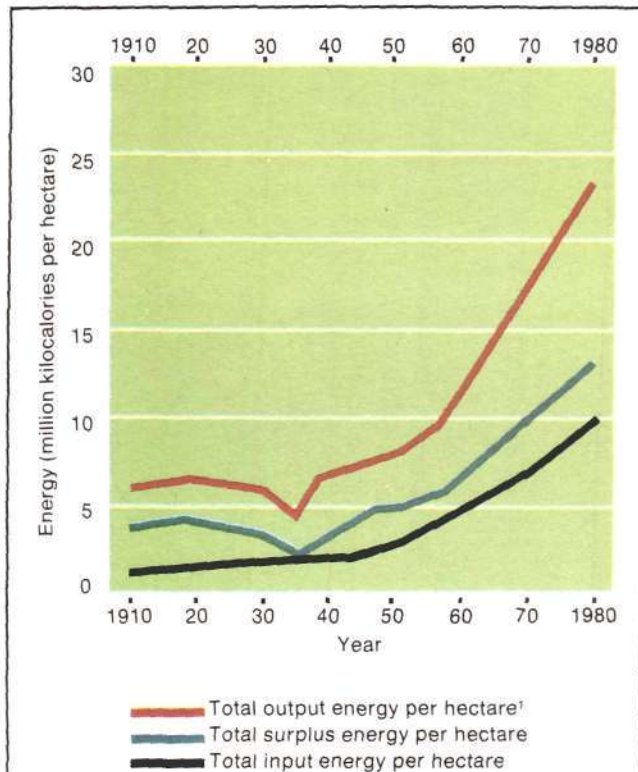

**Figure 1**  
**GROWTH RATES OF INPUT AND OUTPUT ENERGY IN U.S. CORN PRODUCTION**

The rapidly growing energy surplus in U.S. field corn production since 1940 is the result of qualitatively improving and consolidating the technologies of machine, genetic engineering, and land-modification systems.

Source: USDA Agricultural Statistics  
1. Pimentel et al., *Science*, Nov. 1973.

The reader should note the constant rate of surplus energy between 1910 and 1925, the precipitous drop in 1930, and the steady recovery and climb between 1930 and today. These periods correspond to the relatively labor-intensive small farms prior to the 1930s depression, the drought of rainfall and available capital formation during the depression, and the increasing assimilation of scientific methods by farmers after the depression.

There are three relationships to examine here: First, compare the absolute values of energy output to input; second, compare the first derivative (rate of change) of each energy ratio taken separately and the direction of such change (negative, static, or positive); and third—and

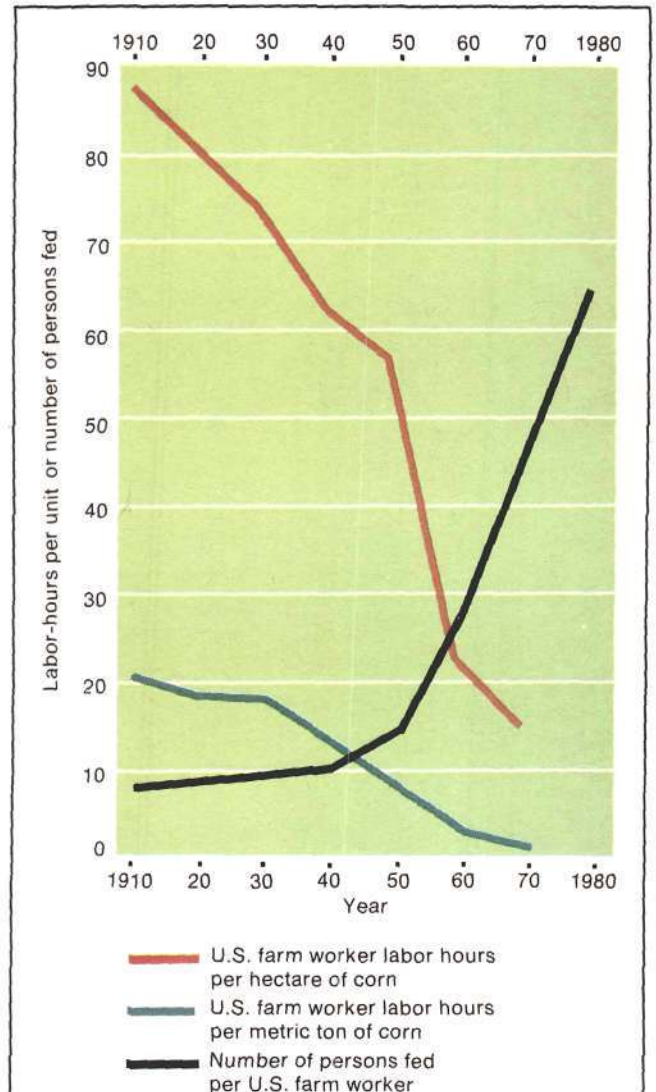

**Figure 2**  
**U.S. FARM LABOR PRODUCTIVITY, 1910-1980**

Each U.S. farmworker in 1978 produced the food requirements for 65 persons, an enormous jump in productivity from 1910.

Source: USDA Farm Production and Efficiency, 1978.



most interesting—look for significant second-derivative changes in the momentum of change, reflected by periods of deceleration or acceleration, particularly of the absolute difference between energy output and input.

In the energy data from 1910 to 1980 in Figure 1, output energy not only clearly exceeds input energy—but the velocity of growth of output energy exceeds that of growth of input energy, with definite points of acceleration in 1935 and again in 1954. The negative and decelerating rate of output energy generated during the early 1930s was turned around by appropriate investment policies in large irrigation, drainage, and soil-conservation infrastructure. Such infrastructure combined with concurrent increases in agricultural research, development, and on-farm assimilation through university agricultural extension programs and private manufacturing sources caused the major rebounds in the generation of surplus energy in 1935 and 1954.

In terms of farm labor productivity, the impact of surplus energy generated is even more graphically demonstrated (Figure 2). The geometrically increasing rate of productivity per worker per year has freed up farm laborers for other agribusiness positions. Today there are four agricultural service or industrial operatives for each direct farm operative.

The comparison of qualitatively different modes of production during the same time period is a useful way to measure the relative thermal efficiency of each mode. Taking Mexico as an example, that nation's agriculture provides three distinct modes of production including relatively capital-intensive irrigated land, modestly capital-intensive or efficient rainfed land, and extremely labor-intensive or subsistence rainfed land (Figure 3). Comparing the total input energy per unit volume of corn production for both the United States and Mexico in 1978 shows the superior energy efficiency of capital-intensive methods.<sup>1</sup>

Most interesting is that *on the basis of energy input per unit output*, the higher-energy-consuming irrigated corn represents only 80 percent of the energy investment for efficient rainfed land and only 40 percent of that for subsistence rainfed land.

Recent tests by the University of Nebraska confirmed this result, showing that irrigated corn required 50 percent less energy input per unit of output than similarly cultured but unirrigated corn in a nearby area. Another 1975 study by Makhijani of the energy budgets for average rice production in the United States, Japan, China, and India showed that the capital-intensive methods of the United States and Japan require only about 58 percent and 32 percent, respectively, of the input energy per unit of

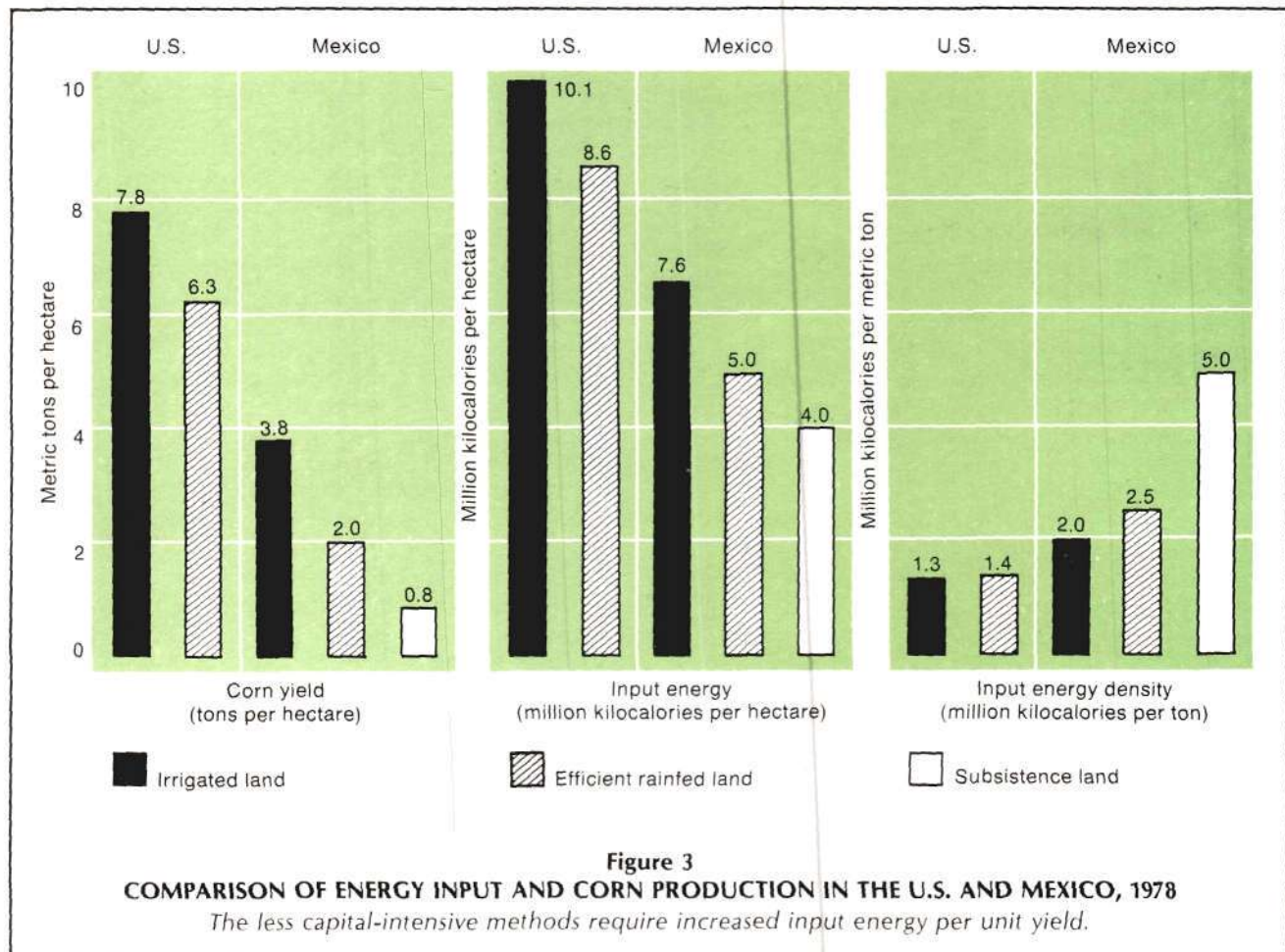



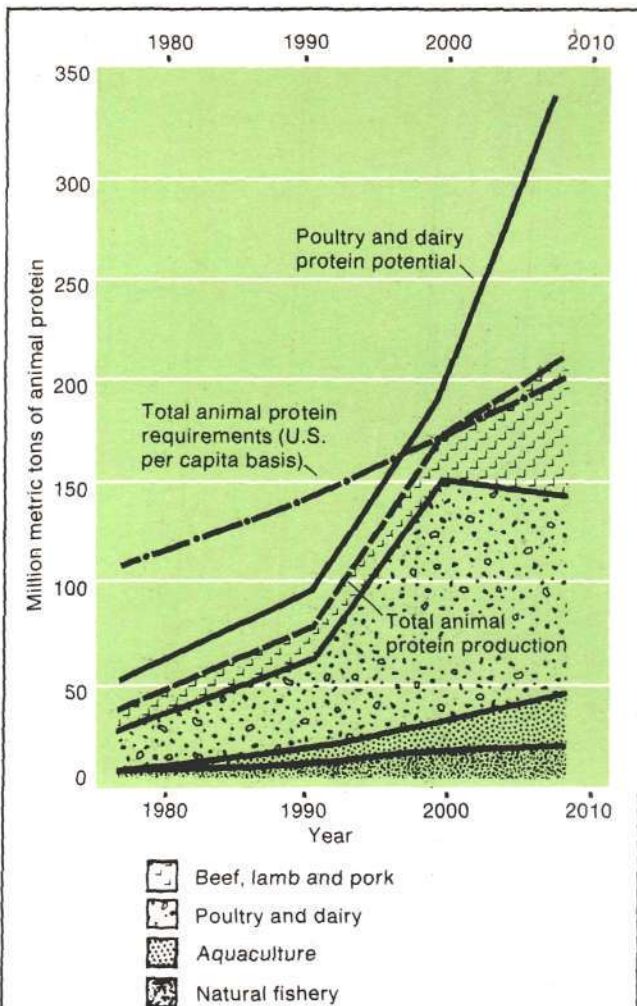

**Figure 4**  
**PROJECTED WORLD ANIMAL PROTEIN REQUIREMENTS AND PRODUCTION**

Using capital-intensive methods of grain and animal production, a fivefold increase in world animal protein production can be achieved by the year 2000. At present 870 million tons (MT) of food grains are grown on cropland of about 385 million hectares Mha, with the remaining land (out of a total of 1,250 Mha) in vegetable or cash crops. By shifting cropland from food grain to feed grain and increasing yields per hectare, feed grain production can be increased to 1,980 MT on 660 Mha in 1990 and 4,115 MT on 915 Mha in the year 2000. Food grain and vegetable consumption will continue at U.S. levels.

The animal protein potential shown on the curve represents levels of converting feed grains into protein by beef (lowest efficiency) or broilers and dairy (6 times higher efficiency), all based on present U.S. methods. After the year 2000, there would be an increasing ratio of beef consumption to that of broilers and dairy.

output as the labor-intensive methods of mainland China and India.

### Feeding the World Population

The problem of bringing the world population up to U.S. dietary standards should be seen simply as extending American methods of farming to the rest of the world—exporting U.S. farm technology. If the United States starts now, by the year 2000 U.S. per capita consumption could be the norm for 6 billion persons around the world.

The goal is to vastly expand the production of animal protein. Providing animal protein in the human diet has been made a political football by the environmentalists, but the scientific fact is that animal protein products are the best way to meet man's dietary requirements.

Animal products have a coefficient of digestion of 0.97, compared to 0.89 for cereal grains and 0.65 for vegetables. Animal proteins contain amino acids lacking in cereals and vegetables that an omnivore like man requires for rapid, complete metabolic assimilation of nutrients. Furthermore, brain development in infants and disease resistance in adults are directly related to diets relatively high in animal proteins. Since continuous increases in the productive intellectual performance of the workforce are the prime mover of the economy, the political decision to limit this engine to inefficient fuel is like using low-octane gasoline in a high-performance machine.

Protein requirements vary by sex, maturity, and the degree of strenuous activity. Hard laborers require as much as 190 grams of protein daily, perhaps averaging about 140 grams. The U.S. National Research Council recommends 65 grams per day for men and 55 for women; but the British Medical Association suggests between 80 and 100 grams per day per person. The U.S. population now consumes about 100 grams of protein per capita day: 70 grams of animal origin, 17 of grain origin, and 13 of vegetable origin.

Taking present U.S. per capita consumption as the target, a conservative projection of world animal protein requirements for the year 2000 is shown in the table and in Figure 4. The production of animal protein on the order of 165 million tons per year—a fivefold increase from current production levels—can be readily accomplished by a program that emphasizes intensified production of high-nutrient feed grains and animal units of high grain-conversion efficiencies, such as poultry and dairy cattle.

By shifting cropland from fiber and fodder crops and increasingly from food grains like wheat and rice to high-energy feed grains, and by increasing yields per hectare, feed grain production can be increased to 1,980 million tons (MT) on 660 million hectares (Mha) in 1990 and 4,115 MT on 915 Mha in the year 2000. Vegetable protein requirements can be met by intensively mechanized truck farms and, increasingly, by large-scale, closed-environment hydroponic methods now under development.

Increases in average grain yields per hectare can be achieved immediately on good cropland by the application of U.S. capital-intensive methods—mechanization, hybrid seeds, chemical fertilizers, and pesticides. The



extension of capital-intensive methods to more marginal lands is dependent upon major advances in irrigation, drainage, and transportation systems—including large-scale, integrated water-supply grids.

Under such conditions, the increases the table projects in both grain cropland under cultivation and yields are actually quite modest. Today's rice yields in Japan and the United States exceed 5 metric tons per hectare (T/ha); irrigated wheat in Arizona and northern Mexico is about 4 T/ha; and average U.S. corn yields exceed 6 T/ha. Furthermore, concurrent advances in the science of genetics, nutrient conversion processes, and efficient energy production were *not* assumed in the projection, even though such advances can be fully anticipated in the context of such a capital-intensive program. By permitting increased energy throughout, such advances would totally redefine the resource base of this projection and accelerate production qualitatively and quantitatively.

Initially, the projected program calls for rapid growth in poultry and dairy cattle production, especially in the underdeveloped sector, because of the high grain-conversion efficiency of these animals. Poultry and dairy cattle convert feed grains into protein at six times the efficiency of beef (see Figure 6).

Methods are now available or in the development stage that permit greatly intensified "yields" in animal production. Rapid growth in poultry and dairy cattle production have been realized through the use of intensive confinement systems and high-nutrient grains, especially corn.

One of the most promising areas for expanding the source of animal protein is aquaculture, high-technology fish farms established near food sources that have high concentrations of organic wastes. In tests using raw urban and agricultural sewage, including poultry manure, fish yields of from 30 to 60 metric tons per hectare of pond have been obtained. Intensively developed coastal and riverine fish hatcheries designed with multipurpose hydraulic projects can similarly augment natural fishery yields.

The rapid expansion of poultry, dairy cattle, and fish production will lay the basis for a more differentiated and therefore healthier diet, including a mix of pork and beef with poultry.

### The Malthusian Opposition

Today's Malthusians say it can't be done; resources are limited and the pie is shrinking. Discarding science, they prefer to cut world population in half and force the remaining population to accept less—less energy, less food, less technology.

The agricultural analysts in the "limits to growth" school ignore the concept of increasing energy density; instead they look at the statistics presented here and see only that the energy input in U.S. agriculture has increased. For example, agricultural researcher David Pimentel from the New York State College of Agricultural and Life Sciences, who compiled the data used in Figure 1, comments that the ratio of output versus input energy decreased by 24 percent between 1954 and 1970 and that corn yields

FOOD PRODUCTION GOALS FOR THE YEAR 2000			
WORLD PROTEIN REQUIREMENTS (millions of tons)			
	1978	1990	2000
Animal sources	108	138	164
Grain sources	26	33	40
Vegetable sources	20	26	31
All protein sources	154	197	235
World population (in billions)	4.2	5.4	6.4
WORLD GRAIN PRODUCTION			
	1978	1990	2000
<b>World food grains</b>			
Cropland (millions of hectares)	386.2	240	110
Yield (tons per hectare)	1.9	2.3	3.0
Production (millions of tons)	734.3	550	500
<b>World feed grains</b>			
Cropland (millions of hectares)	347.3	660	915
Yield (tons per hectare)	2.2	3.0	4.5
Production (millions of tons)	749.1	1,980	4,115
<b>Other cropland</b> (millions of hectares)	515	400	350
<b>Total world cropland</b> (millions of hectares)	1,250	1,300	1,375
WORLD ANIMAL PROTEIN PRODUCTION (millions of tons)			
	1978	1990	2000
Beef, lamb, and pork	12	13	20
Poultry and dairy	13	45	115
Aquaculture	1	6	15
Natural fishery	10	11	15
Total animal protein	38	75	165

*To feed the 6 billion people in the world at current U.S. levels requires a transformation of world agricultural production practices. Shown here are the global nutrient requirements for the next 20 years, and the changes in necessary agricultural outputs that will occur as capital-intensive advanced technologies increasingly come on line.*



increased by only a factor of 2.4 while the energy input during the same period increased by a factor of 3.1.

Pimentel's argument is misleading. Increases in the rate of productivity growth in any economic domain are limited as long as expansion remains in a fixed technological mode. Pimentel ignores the crucial fact that output energy per area unit was increasing more rapidly with time than input energy—that is, reinvestable surplus was increasing—laying the basis for proceeding to the next technological mode and effecting future leaps in productivity. (For a general discussion of short-term versus long-term productivity effects see, "Economics Becomes a Science," *Fusion*, July 1979, p. 32.)

Not only does Pimentel attack energy use and the high technology that requires energy-intensity, but he criticizes the advanced sector for eating too much animal protein. One thousand kilocalories of plant food equivalent, Pimentel says, costs \$10 per capita for an average grain-based diet in India and \$38 in the United States, which consumes 10 times more animal protein. Pimentel's solution? Instead of gearing up to produce more animal protein more efficiently, the advanced sector should adopt the inadequate diet of the Third World.

This is totally incompetent science. The limits-to-growth perspective denies the historical fact that new energy technologies have always created new energy resources. And even after 50 years of cheap oil, the Malthusians ignore the science that obtained and used this new resource, which, through the greatest energy-intensive use, created the surplus wealth that has provided the basis for creating the new energy resources of the future—fission and fusion. As these resources are further developed, they, in turn, will be the means for providing us with a new synthetic fuel—hydrogen—that will be far more plentiful and more efficient than fossil-based fuels.

Pimentel's solution, like that of the just-released *Global 2000* study [see Washington section, this issue] and the many Club of Rome reports, is not just bad science. To heed the limits-to-growth warnings would be to collapse the American population to Third World living standards, pushing an increasing number of persons back to the farm, and to hasten the elimination by starvation of millions of persons now living under substandard conditions.

### The High-Technology Solution

The critical index in measuring agricultural progress is the time rate of growth of the rate of free energy generation. To maximize this index there must be an optimal combination of the use of mechanization, chemicals, and irrigation and an increasing energy flux density of energy inputs. The use of these inputs in combination not only maximizes the rate of surplus energy production, but also reduces the amount of each input needed compared to the amount that would be needed if other major categories of input were absent.

In the next sections I shall explicitly demonstrate this by comparing the energy inventories of advanced-sector and developing-sector agriculture and the improvements in thermal efficiency associated with large-scale utilization of

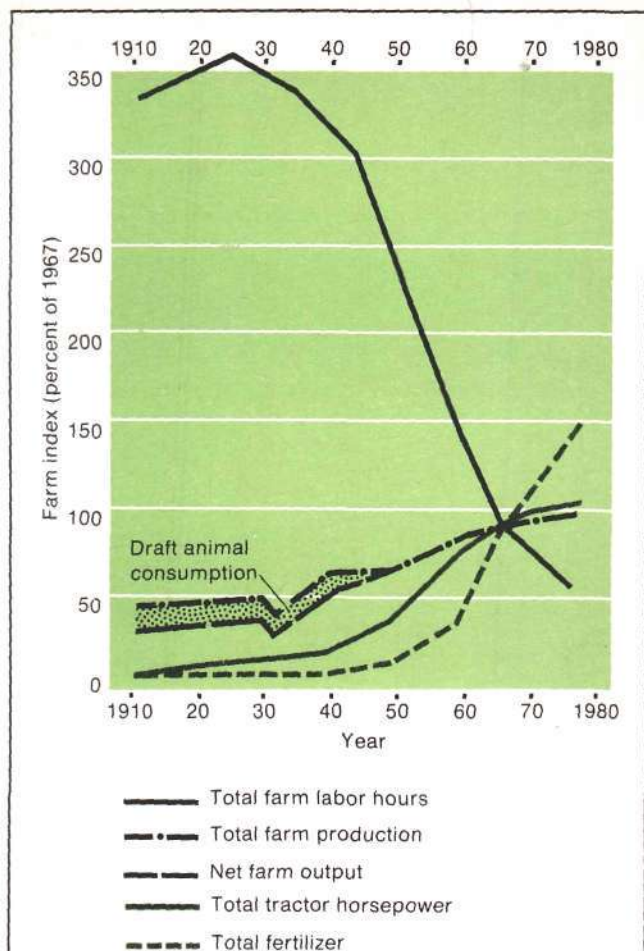

**Figure 5**  
**INDEXES OF U.S. AGRICULTURAL PRODUCTION, 1910-1980**  
(1967=100)

The rise in the index of tractor horsepower from 15 percent in 1915 to 100 percent in 1967 is one of the main reasons that U.S. agricultural output doubled in the same period.

Source: USDA, *Farm Production and Efficiency*, 1978.

mechanization, agricultural chemicals, and irrigation.

This then makes it possible to formulate specifically the most efficient program for world agriculture to meet the nutritional needs of a growing world population. It is no accident that programs formulated on a different basis, whether or not they are originally motivated by Malthusian ideology, end up calling for genocidal reductions in the world population.

Increased agricultural production densities are not simply statistically correlated with increased energy densities on the farm; the two are causally linked. The rise in the index of U.S. tractor horsepower on farms from approximately 15 percent to 100 percent in the 1915 to 1967 period is a chief cause for the corresponding 50 percent rise in total agricultural output (Figure 5).





USDA

*Today's hydraulic-PTO tractors, with a sustained horsepower of 200, have increased the power density for U.S. agriculture to 5,000 times that of a single toiling man and 1,000 times that of a draft animal. The first tractors (1910) were only 250 times more energy dense.*

On a sustained power basis, the early tractors of the 20th century were about 250 times more powerful than an individual man and 50 times more powerful than a draft animal. Furthermore, draft animals consume more than three times the operating energy per unit of production than today's power-dense machines. (In 1915, some 27 million draft animals consumed about 28 percent of U.S. agricultural output.)

The development of power transmission accessories for mechanical equipment such as power-take-off (PTO) driven implements and hydraulic-lift units coupled directly to the tractor's power system have increased the power ratio per unit—given today's large 200-horsepower tractors—to about 5,000 times that of a single toiling man or 1,000 times that of an animal. Between 1940 and 1980, the

growth of installed horsepower on U.S. farms has increased more than fourfold. In the same period the total machine horsepower per farm worker has increased from about 7 to 92.

One of the ways that farm mechanization has boosted the yields of U.S. agricultural production is by allowing the use of hybrid varieties of crops such as corn. These higher-yielding hybrid varieties require longer growing seasons, which reduces the time available for farm tillage and harvesting. Thus the high yields depend on the availability of pump drainage systems for wet fields, and multiple, high-powered machinery units for planting and harvesting.

Where an adequate level of mechanization does not exist, the potential of the high-yielding hybrids is lost. A



late, wet spring and an early, cold fall can result in a drop in effective yield of as much as 1 to 3 percent per day of delay.

### Agricultural Chemicals

The more widespread and intensive use of farm chemicals representing higher unit energy densities was predicated in part on the mobility and adaptability of farm machines. The rise in use of fertilizers lagged behind the rate of rise in tractor horsepower through the 1930s and 1940s, and then accelerated rapidly in the 1960s and 1970s. Qualitative changes in the production of both machines and fertilizer combined with the sustained high yields of leading farmers caused the rapid rise in use. Average U.S. corn yields, which had stagnated below 2.0 T/ha (32 bushels/acre) from the Civil War to World War II, increased to 2.5 T/ha (40 bushels/acre) in 1954 and then exploded to over 6.3 T/ha (100 bushels/acre) today.

The most important fertilizer constituent is nitrogen, which is extremely unstable in the liquid form that is most readily assimilated by plants. New methods of directly applying liquid ammonia or urea crystals near plant root systems in utilizable concentrations based on the stage of development of the plant have been able to reduce residual losses and the materials costs of farmers.

Throughout the growing season plants require an optimal combination of air, water, and nutrients accessible to their roots. The use of flood or furrow irrigation methods provides alternating overly wet or overly dry conditions in the root zone. In overly wet conditions applied fertilizer is leached below the root zone; in overly dry conditions fertilizer, which must be in solution for plant absorption, is effectively unavailable. The use of sprinkler methods, which have a 70 to 80 percent plant-use efficiency compared to about 40 to 50 percent for flood or furrow methods, has greatly improved fertilizer-use efficiency as well. Smaller, more frequent irrigation applications by pressurized sprinklers optimize air-water-nutrient ratios compared to gravity systems. The use of fertilizer solutions in sprinkler systems has also added to the overall efficiency of irrigated agriculture.

From any competent standpoint, the proposal to use animal dung fertilizers is outlandish. About 116,000 kilograms per hectare of animal manure are required to achieve the nitrogen equivalent of 207 kilograms per hectare of chemical fertilizer commonly used in high-yield U.S. corn production. Thus, chemical fertilizer is some 560 times more energy dense than manure.

The campaign against the use of insecticides and herbicides for improving both crop production and controlling the breeding of disease carriers is one of the biggest frauds of this century, as documented in an accompanying article. The importance of DDT, for example, which was banned in the United States in 1972, can be seen from the fact that the yields of insect-sensitive crops like cotton, peanuts, beans, and potatoes increased from 68 to 119 percent after DDT use, and total agricultural output in malaria-infested areas increased as much as 40 percent with control by DDT.<sup>2</sup>

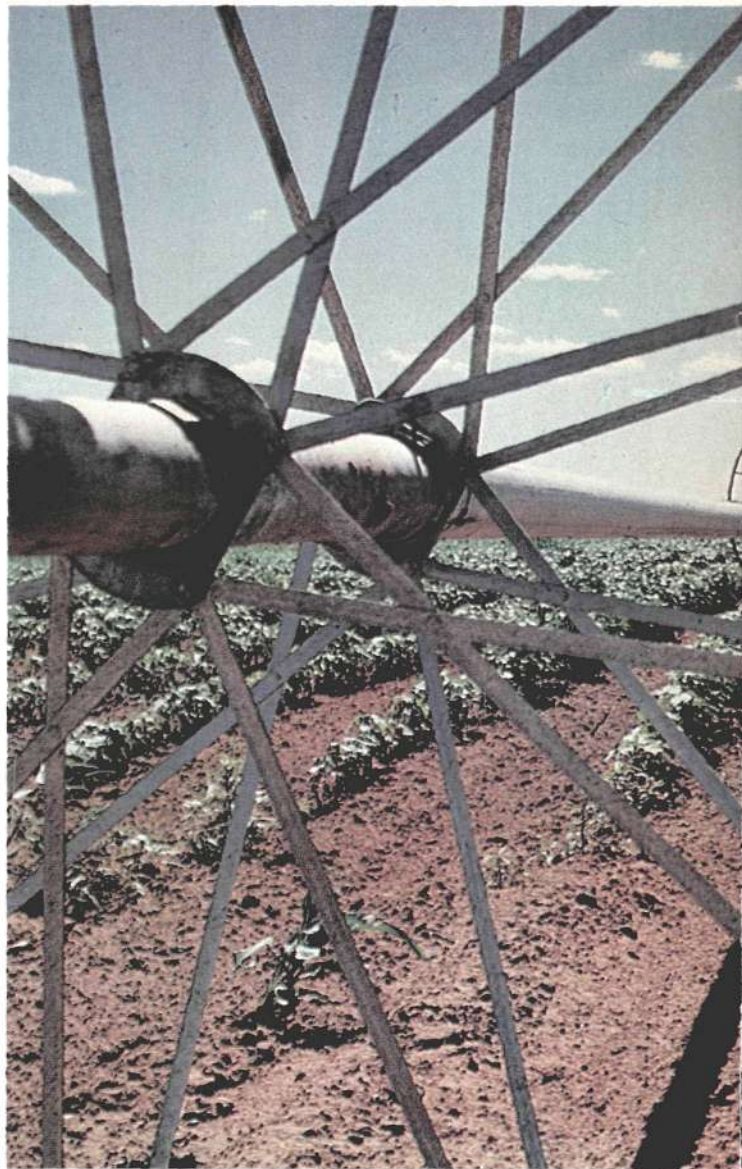

Herbicides, used for controlling weeds and reducing cultivation operations, require less energy to produce and apply than that required in operating fuel for mechanized cultivation. For comparable results, hand-weeding methods require 1,200 times more labor than herbicide use.

### Land Engineering

The modification of the soil and layouts of field and farm systems are essential components of agricultural production density and energy efficiency. Irrigation, drainage, erosion control, and flood control all provide a more consistent plant environment in which yields can be sustained against otherwise certain losses caused by intermittent natural events (drought, or flooding by direct rainfall or river overflow). Subsurface drainage using vitrified clay tile or plastic pipe has been shown to increase yields in lowlands and swales by at least 50 percent—an



*High-technology irrigation has increased yields up to four times that for comparable rainfed land—with 50 percent less energy input. Below: a center pivot irrigation system near Amarillo, Texas. At left: a wheel roll irrigation system.*

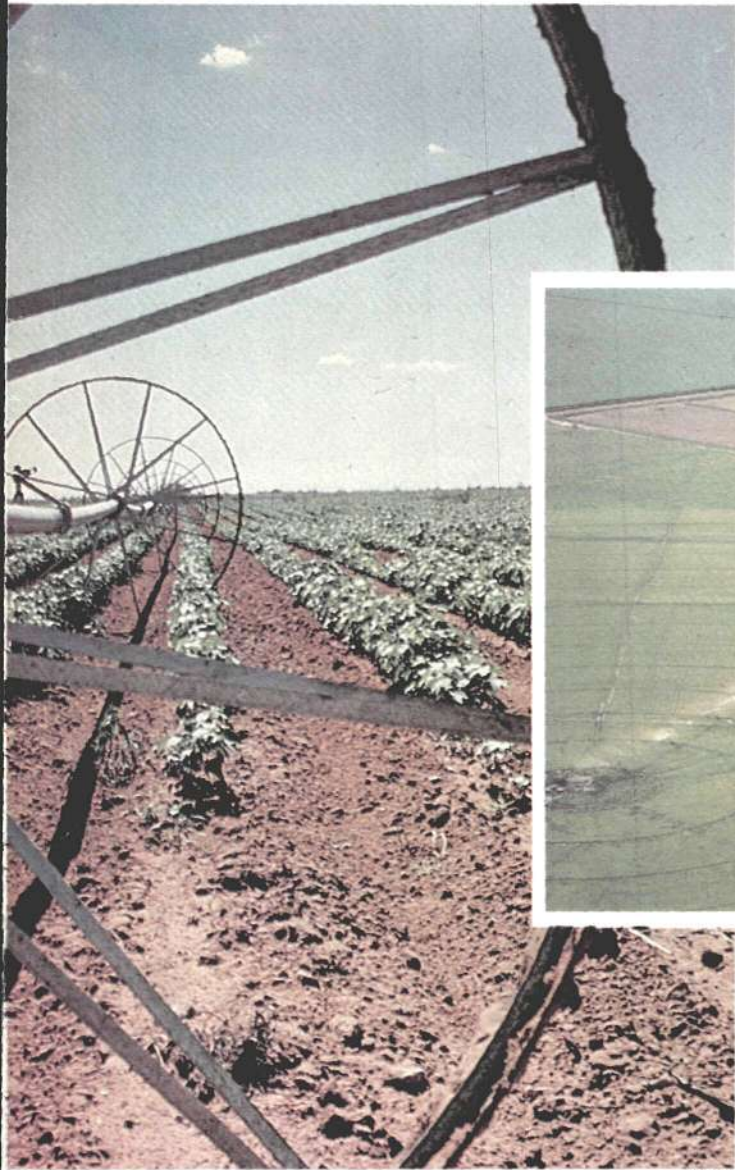

Photo by Fred S. Witte/USDA

USDA

especially effective method in the heavy clay soils of the Mississippi Valley. Supplemental irrigation in Nebraska not only increased yields to four times higher than comparable rainfed land, but the overall energy input per unit of production was only 50 percent that of the rainfed land.

In the lighter, silty-sand soils typical of the High Plains states from Montana to Texas, erosion by wind and rainfall runoff has been retarded by extensive systems of windbreaks and contour strip-cropping terraces engineered to conserve both rainfall and soil while allowing use of modern wide field equipment. The combined use of large-scale and small-scale flood water-retarding structures and contour farm practices in the programs of the USDA Soil Conservation Service, the Bureau of Reclamation, and the U.S. Army Corps of Engineers, have both reduced upland soil losses and increased the building of soil structure and fertility necessary for continued good yields. Furthermore, the Soil Conservation Service has shown that farms of 500

acres with good field layouts to minimize turn-around and incidental operating trips are twice as fuel efficient as smaller farms of 100 acres.

The development and increasing use of genetic and environmental improvements in crops and livestock are critical components in the high production densities of U.S. agriculture. Yields of crops and livestock are dependent on the consumption of nutrients in excess of basic metabolic requirements in an environment conducive to the assimilation of those nutrients. The United States and other industrial countries out-produce less-developed countries by factors of from 2 to 5 per area unit and animal unit because of a political and economic commitment to the continued optimization of this process.

The development of hybrid seed is a good example of the assimilation of innovations in scientific agriculture. Hybrid seed is bred annually to achieve full, uniform seed and stalk development in a parasite-resistant, disease-resistant plant. With the assistance of manufacturers, seed varieties are selected by growers to optimize production on specific fields according to required climate, local soil conditions, and mechanical and chemical practices. Seed production is a full-time, scientifically directed component of agribusiness whose development is directly linked to the increased production densities of U.S. agriculture.

About 40 percent of the increased corn yields since 1940 is the result of hybrids. In the late 1930s, about 10 percent



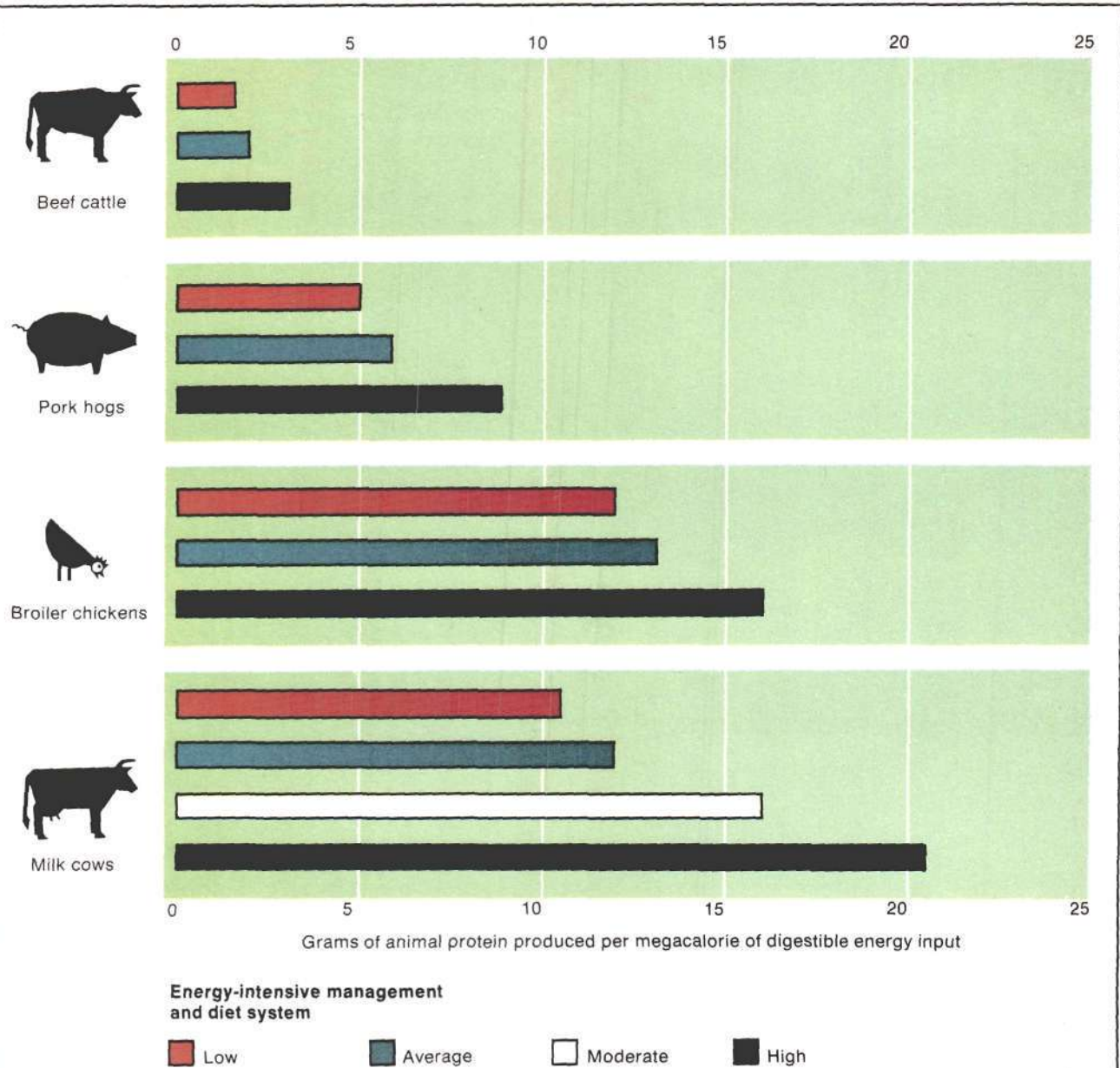

**Figure 6**  
**U.S. ANIMAL PROTEIN PRODUCTION PER UNIT OF DIGESTIBLE ENERGY INPUT**

The conversion of the input dietary energy into animal protein increases in efficiency as the nutrient density of the diet increases. U.S. grain conversion efficiency is at the average level shown here.

Source: Dr. J.T. Reid, *Energy Utilization in Animal Production*, Cornell University, 1976.

of the farms in Iowa used hybrid corn; 15 years later 90 percent of Iowa farms were using it. Alabama, because of its less developed economic infrastructure, lagged behind Iowa in hybrid corn use by another 15 to 20 years. But developing nations, in properly directed economic development around the world, can immediately apply the successful products of biological engineering as well as of agricultural chemicals and mechanization.

The process of increasing energy flux density by capital-

intensive methods applies equally to livestock products. As shown in Figure 6, the conversion of the input dietary energy into animal protein increases in efficiency per unit of energy input as the nutrient density of the diet increases. Of course, management factors such as a clean, controlled living environment are essential to such a process. This important result confirms again that, for the same unit of energy, higher forms of agricultural technology produce significantly more usable products.

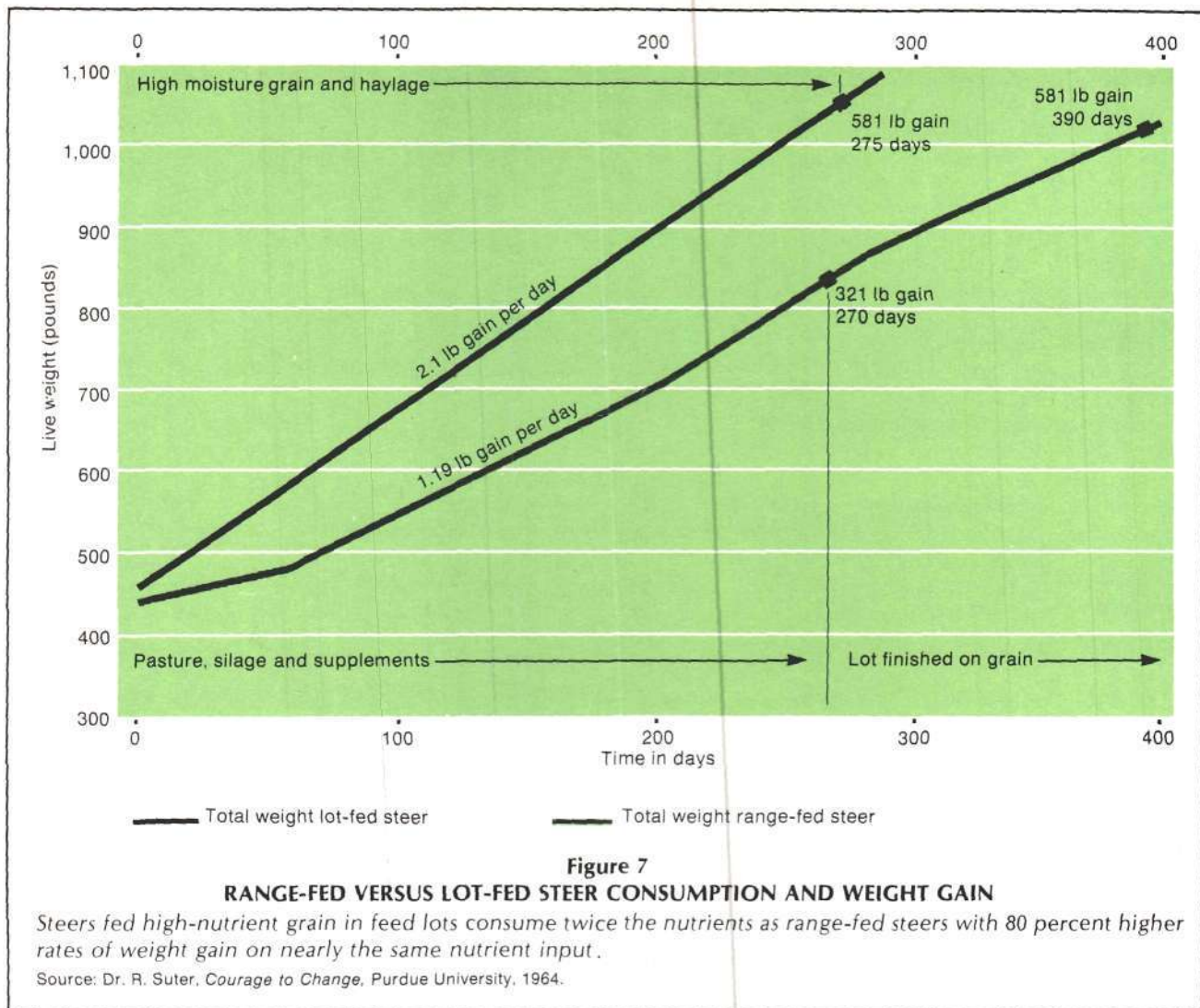

Dairy and poultry protein conversion is most efficient. However, the average production of milk per cow in the underdeveloped nations is about 20 percent that of the industrialized countries because of the combined effect of inadequate diet, disease, and parasites. The United States, France, and Mexico each have about 11 million cows; yet France and Mexico produce only about 60 percent and 15 percent, respectively, of the milk per cow produced in the United States. On the other hand, Japan and California have about 930,000 and 830,000 cows, respectively, and produce 125 and 133 percent of the U.S. average per cow.

Mechanization of livestock production has similarly boosted yields of animal products per acre and volume of feed input. Using modern forage equipment and mechanized handling, storage, and feeding equipment, farmers can efficiently deliver scientifically balanced rations to meat, poultry, and dairy animals with increased feed-to-product efficiencies and more rapid gains in the time of maturity of the animal unit.

Average U.S. production of beef steers fed on extensive,

good, range-land pasture with winter silage and hay requires an input energy of 32 cultural and 690 dietary megacalories per kilogram of protein produced, a total of 722. (Cultural here refers to energy other than dietary input, for example, that required for building fences, etc.) However, steers fed on feed-grain concentrates in intensively mechanized feed lots require a total of about 624 megacalories per kilogram, 54 for cultural and 570 for dietary purposes. Compared to range-fed animals, the lot-fed animals produce 80 percent more meat during the same feeding period—more than double the rate of gain on nearly the same nutrients (Figure 7).

This is understandable given that animals as well as plants require a certain threshold level of energy intake for basic metabolic sustenance—including bone and fiber development. Rates of nutrient intake in excess of the threshold level produce the surplus harvested by man. However, qualitatively more dense nutrients in a clean, noncompetitive environment produce higher rates of surplus—rates that increase geometrically with the nutrient density.



As the champion of world agricultural science, the United States has a unique role in directing a scientifically based program of world agricultural development. The United States ranks second as one of the big four politically unified regions in the world in arable area (Soviet Union, 230 million hectares; United States, 188; India, 155; and China, 125), and is perhaps second to India in total agricultural potential based on the critical resources of water, land, and climate. However, the key U.S. role will be not as an exporter of raw food products, but rather as an exporter of the technology of food production, including both "hardware" and "software" systems—or operating methodology.

Since Benjamin Franklin's "Proposal for Promoting Useful Knowledge in America" in 1743, the United States has been the laboratory for developing technologically vectored industry and agriculture. In Franklin's words, this process was necessary "to increase the power of man over matter." Today the nation has developed agriculture as a science using the foundation established by Franklin and later by Alexander Hamilton in his 1791 *Report on the Subject of Manufactures*: capital-intensive agriculture that frees human labor to develop qualitatively higher forms of industry and agriculture based on scientific research.

What is required now to continue this American tradition is explicit, as laid out in this report; equally explicit is the Malthusian scenario that will ensue if the nation does not follow the high-technology path.

*Calvin Larson, a staff member of the Fusion Energy Foundation, is an engineer specializing in water and agriculture with many years experience in the Midwest and West.*

#### Notes

1. A discussion of how capital-intensive methods have dramatically increased productivity in selected areas in Mexico appears on page 70.
2. Readers can find the full story on DDT, "The Great DDT Hoax," in the June 1979 issue of *Fusion*, page 60. This article is available as a reprint at \$1.25 per copy postpaid from the FEF.

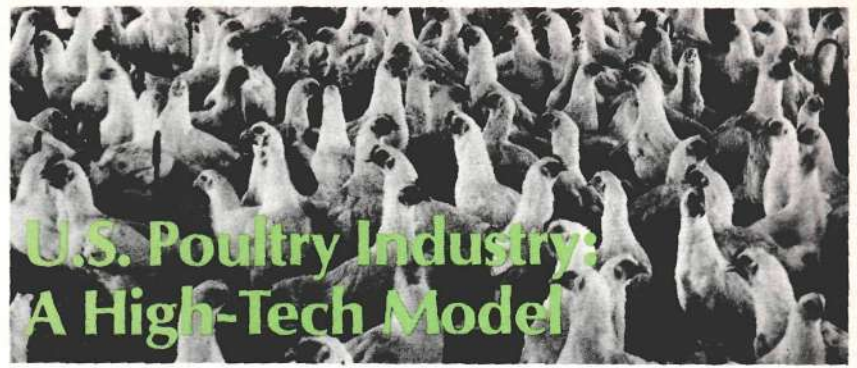

**T**he U.S. poultry industry is the single most scientifically and technologically advanced agricultural enterprise in the world. It has enjoyed the greatest advances in productivity in terms of yield per worker of any agricultural undertaking. These productivity achievements have resulted from scientific study and technological applications in poultry genetics, nutritional and environmental requirements, and harvesting of products.

The overall productivity per worker in this capital-intensive sector over the last 20 years demonstrates the power of introducing new technologies (Table 1). For the industry as a whole there has been more than a sixfold increase in output per employee, and this understates the gains achieved by poultry farmers using the most advanced methods.

The industry actually comprises two separate operations: broiler poultry for direct consumption and eggs, which together hold tremendous potential for increasing high-protein nutritional supplies worldwide.

#### Broiler Production

The well-bred chicks that are to be used in the production of broilers are sent to growers, where they are raised for a six- to seven-week period. The growing facility consists of an airplane-hanger-like building, built to maintain the proper environmental conditions of light, heat, and ventilation for maximum growth rates. A typical broiler house is 40 by 400 feet, housing 20,000 birds, with equipment for feeding and watering them. The birds are free to walk about through-

out the building. When they have reached the proper size for processing they are manually caught and caged for transportation to the processing plant, usually located several miles away. Recently cage systems have been developed in which the chicks are placed in cages for their entire growth period and subsequent transportation to the processing facility. This also allows for the operation of space- and labor-efficient, vertical grower buildings.

At the processing plant the birds are removed from the cages and hung by their legs on a lattice. They remain suspended on this apparatus while they are stunned, killed, scalded, defeathered, eviscerated, washed, and graded. They are then packed, frozen, and sent to market for distribution. The processing houses are large, highly automated facilities, employing 100 to 150 workers to process 50,000 broilers per day.

#### Egg Production

The newly hatched chicks that are genetically selected for egg production are raised as replacement hens for the egg producers. They reach maturity at about 22 weeks of age, and are productive for approximately one year. The egg producer places the birds into four-bird cages where a hen will remain until it is no longer productive and is sold as fowl. The modern facilities are totally automated, with water and feed available as needed. Egg collection is completely automated: A well-equipped facility of 100,000 hens, laying 60,000 to 70,000 eggs per day, can be operated by three workers. Manure is re-



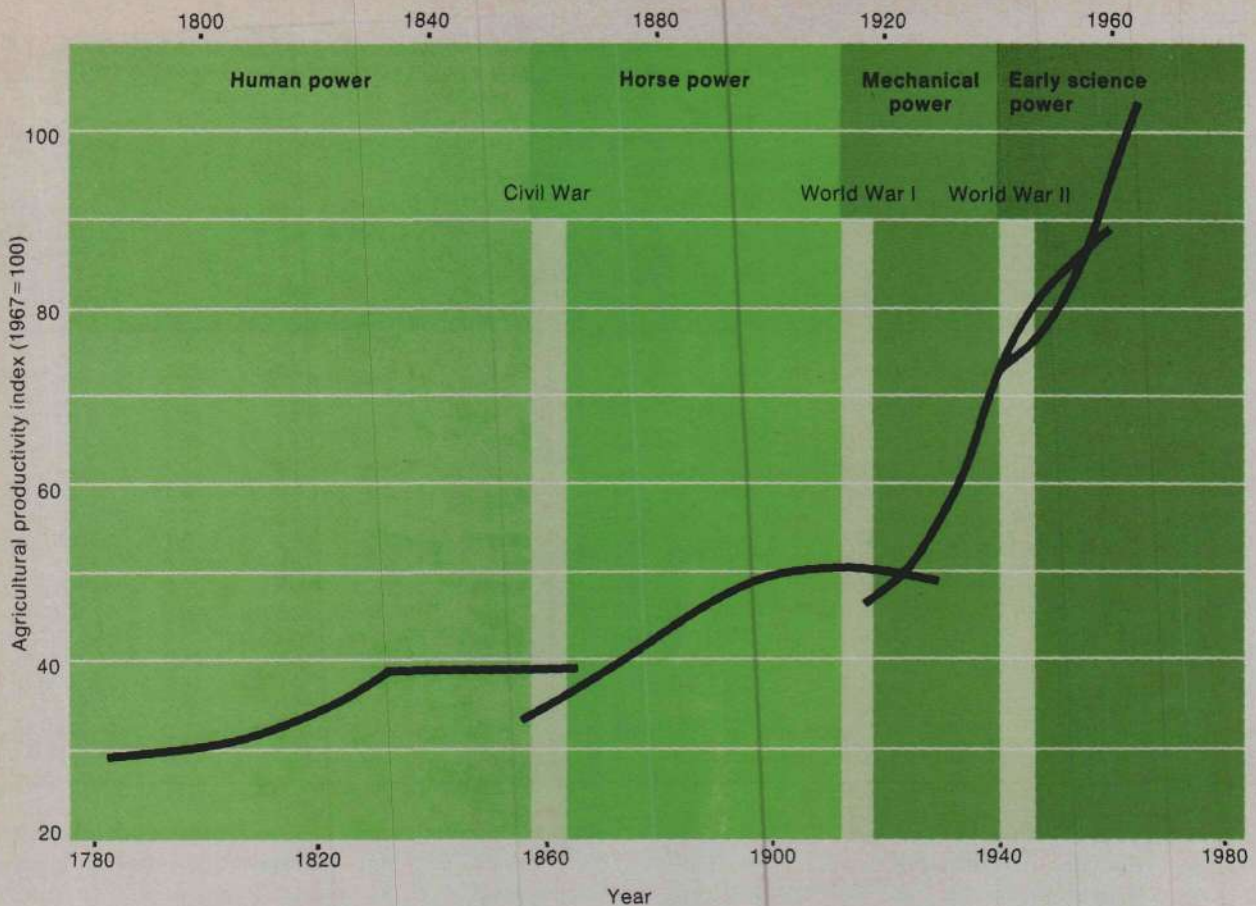

**Figure 1**  
**U.S. AGRICULTURAL PRODUCTIVITY GROWTH DURING THE PAST 200 YEARS**

Scientific and technological progress in agriculture and the economy as a whole has defined three major periods in American agricultural development.

From the Civil War to World War I, the change from human power to horse power and continuous inventions and improvements in farm implements heralded the first phase of mechanization of U.S. agriculture. This resulted in an almost twofold increase in productivity. During this period the commitment to scientifically based agriculture became widespread and institutionalized in the Land Grant College system and the U.S. Department of Agriculture, both established under the Lincoln administration.

The period between World War I and World War II saw the second phase of the mechanization of agriculture, based on mass production of tractors powered by internal combustion engines and the growing availability of large amounts of cheap fuel. The coming of age of petroleum and natural gas also made possible a steadily increasing use of fertilizer. At the same time, the first massive water projects were completed to reclaim arid western lands and in 1914 the Cooperative Extension Service began its work with U.S. farmers. As a result of these advances, agricultural productivity increased to the extent that the great shift in population out of direct agricultural activity became possible.

In the third period, after World War II, research during the war and the technological applications of science afterward introduced the first phase of fully scientific agriculture. The key factors were the use of hybrid crop strains, the widespread use of pesticides and herbicides, the improved nutritional and medical practices in animal husbandry, and the increased use of energy and fertilizers.

The figure shows clearly the shock-wave effect involved in productivity growth. Within the framework of a given mode of technology defined by the basic energy technology, productivity will advance and then tend to level off. Scientific breakthroughs then shift the entire technology mode into a higher order where productivity can make new gains. In the period that the Quance group has called "science power," the productivity curve becomes unlimited.

Source: *The Future of Productivity*, Washington, D.C.: National Center for Productivity and Quality of Working Life (Winter 1977).



**Table 1**  
**MAN-HOURS PER UNIT AND YIELD PER UNIT OF PRODUCTION OF SELECTED CROPS AND LIVESTOCK**  
 (1800 to 1970)

Year	Wheat					Corn for grain				
	Man-hours per acre			Yield per acre (bu.)	Man-hours per 100 bushels	Man-hours per acre			Yield per acre (bu.)	Man-hours per 100 bushels
	Total	Before harvest	Harvest			Total	Before harvest	Harvest		
1970	2.9	1.8	1.1	31.0	9	5.2	2.9	2.3	71.6	7
1965-1969	2.9	1.8	1.1	27.5	11	5.8	3.3	2.5	77.4	7
1960-1964	3.0	1.9	1.1	25.2	12	7.0	4.3	2.7	62.2	11
1955-1959	3.8	2.3	1.5	22.3	17	9.9	6.5	3.4	48.7	20
1950-1954	4.6	2.6	2.0	17.3	27	13.3	8.9	4.4	39.4	34
1945-1949	5.7	2.9	2.8	16.9	34	19.2	12.2	7.0	36.1	53
1940-1944	7.5	3.8	3.7	17.1	44	25.5	16.0	9.5	32.2	79
1935-1939	8.8	4.3	4.5	13.2	67	28.1	17.9	10.2	26.1	108
1930-1934	9.4	4.6	4.8	13.5	70	28.2	17.6	10.6	23.0	123
1925-1929	10.5	5.1	5.4	14.1	74	30.3	17.9	12.4	26.3	115
1920-1924	12.4	6.0	6.4	13.8	90	32.7	19.2	13.5	26.8	122
1915-1919	13.6	6.6	7.0	13.9	98	34.2	20.0	14.2	25.9	132
1910-1914	15.2	7.0	8.2	14.4	106	35.2	20.4	14.8	26.0	135
1900	15.0	7.0	8.0	13.9	108	38.0	22.0	16.0	25.9	147
1880	20.0	8.0	12.0	13.2	152	40.0	28.0	18.0	25.6	180
1840	35.0	12.0	23.0	15.0	233	69.0	44.0	25.0	25.0	276
1800	56.0	16.0	40.0	15.0	373	80.0	56.0	30.0	25.0	344

Each of these techniques has particular limitations, and a great deal of ingenuity is required to obtain the desired results. Nonetheless, researchers are making good progress and expect to achieve the necessary transformations as basic plant processes are better understood.

#### New Bioregulators

Bioregulators are natural or synthetic compounds that can be applied to crops to stimulate growth or enhance ripening, to increase the ability to mechanically harvest a crop, or even to prolong shelf life of the farm-food product.

For example, tricontanol, a natural fatty alcohol that is isolated from alfalfa, has experimentally demonstrated increases in yields of from 34 to 63 percent in asparagus and from 11 to 24 percent in sweet corn. Application to the guayule plant resulted in a twofold to sixfold increase in natural rubber yield. However, we understand little about the basis for this particular bioregulator's effects. What tricontanol demonstrates is the ability to bring about substantial changes in crop yield through biochemical manipulation—an area that must be explored and mastered.

Research into basic physiological and genetic mechanisms are the key here, and will provide the insight required to isolate both artificial and natural chemicals and use them to increase crop yields.

The development of livestock twinning capacity—multiple births in beef cattle and other livestock—will break Mother Nature's chain around this vital nutrition source. The current nonpolitical stumbling block to increasing

beef supplies lies in the bovine reproductive cycle; the cow produces only one calf every year, and an average of five calves over its lifetime. A substantial portion of the nation's herd, therefore, is tied up in the breeding process.

An immediate solution to this overhead problem is the development of a viable twinning capacity for these animals, which would increase the net productive capacity of this sector of agriculture. Research is focusing on several approaches, including selection and hormone induction. Perhaps the most promising method, however, is that of *nonsurgical embryo transplantation*. Embryo transplantation occurs when multiple fertilized eggs (obtained from heifers bred just prior to slaughter) are transplanted to the unbred recipient. Work is being done to fertilize the eggs *in vitro*, combining the most favorable genetic traits of desired donors, both male and female.

A more long-range and desirable solution, one that requires substantially more fundamental research, would be the ability to "clone" steers, but this prospect is not likely for the near future.

#### Other Research Areas

These are some of the frontier areas of agricultural science that would have the necessary shock-wave effects on agriculture. There are several other areas, however, in which research should also be pursued in order to increase productivity, although perhaps with less dramatic results. For instance, the yield possible for a variety of crops is limited by the density possible for each crop, which, in turn, is a genetic characteristic of each plant in question.



**Table 1**  
**PRODUCTIVITY IN THE**  
**POULTRY INDUSTRY**

Year	Output/hour (1967=100)
1955	32
1965	87
1975	175
1976	196

moved automatically, and the eggs are collected, washed, weighed, graded, and boxed by machine. In fact, eggs are never touched by human hands in an advanced facility; every time one is, losses result and productivity drops.

Widespread utilization of the most advanced technologies in production is less advanced in the U.S. egg sector than in the broiler sector. Therefore it is anticipated that there will be large increases in productivity in this area in the near future if financial resources for investment are adequate. Profitability for U.S. egg producers has been hard hit by the anticholesterol scare, and many farmers have maintained production through sheer determination to keep this necessary protein output on line.

The major cost for both broiler and egg production is feed, accounting for over 60 percent of the total costs. In addition to the introduction of labor-saving technologies, scientific advances in the efficiency of food conversion have played a major role in productivity increases for the poultry industry (Table 2). In 1955 over 2.8 pounds of feed were required to yield one pound of chicken (live weight), and 5.5 pounds of feed were required to produce a dozen eggs. Today, only 2.05 pounds of grain will yield 1 pound of chicken, and 4.25 pounds of grain will yield a dozen eggs. It is anticipated that within the near future further increases will bring these numbers down to 1.95 pounds for broilers and 3.65 pounds for eggs.

Current analyses by the USDA confirm the grocery shopper's impression

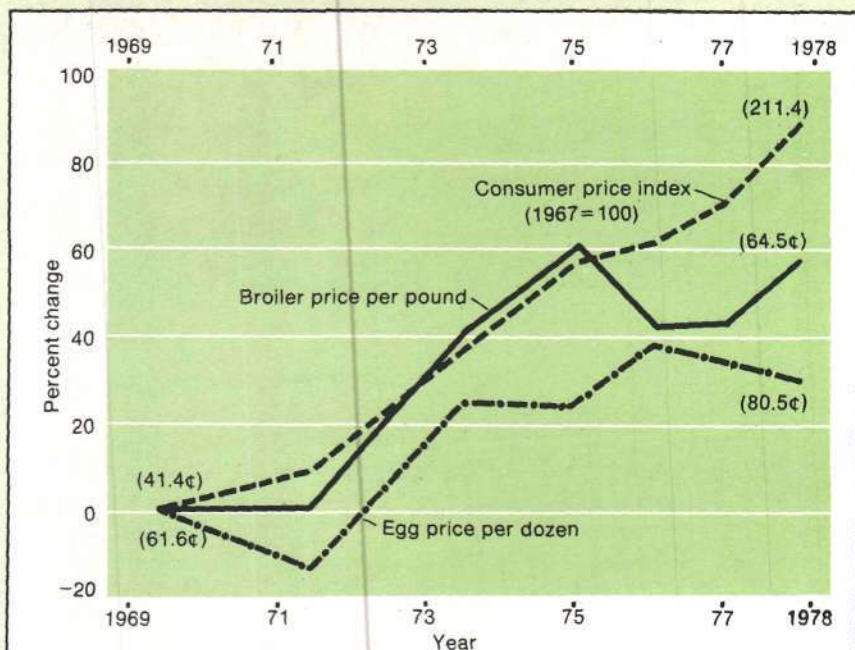

**PERCENT INCREASE IN RETAIL POULTRY PRICES**

Although the consumer price index for food doubled between 1967 and 1978, consumer prices for chicken and eggs rose only modestly because of high productivity gains in the poultry industry.

**Table 2**  
**FEED-CONVERSION EFFICIENCIES**

Year	Broilers		Eggs		
	Feed <sup>1</sup> (lb)	Mortality (%)	Feed <sup>1</sup> (lb)	Eggs/yr	Mortality (%)
1955	2.85	15	5.5	192	15
1965	2.28	—	4.95	218	15
1975	2.10	—	4.25	233	14
1977	2.05	4	4.25	236	12

1. Feed refers to the amount of grain necessary to yield one pound of broiler growth or one dozen eggs.

that both chicken and eggs are among the cheapest sources of protein for the consumer. Although the prices of almost all consumer commodities have drastically increased in the last 10 years, the increase for poultry has been much smaller than for other sources (see figure). Despite large increases in producers' costs from rises in energy prices and credit rates, broiler and egg prices have risen only

modestly because such substantial gains in productivity have been achieved through labor-saving technology, scientific advances in feed conversion, and improved breeding methods.

For these reasons of productivity and grain-conversion efficiency, poultry will be a key industry for feeding a growing world.

—Richard Pollak



# The Frontiers Of Agricultural Science

## *Making Shockwaves In Productivity*

by Dr. Richard Pollak

THE KEY TO FEEDING a growing world is making the scientific research breakthroughs in genetic engineering and plant physiology now that will propel agriculture into a mode appropriate to the era of fusion energy. These breakthroughs are well within the reach of agricultural science today. Along with parallel developments in irrigation engineering and the building of nuplexes, they will ensure that world agriculture has the required increases in energy flux density and productivity to keep pace with a population that is advancing materially and culturally.

The model for such exponential growth is the history of agricultural production here in the United States (see Table 1 and Figure 1). Scientifically based, technologically advanced agricultural practice is the foundation of America's wealth. Accelerating specific research areas now will create the "shock" potential to shift the productivity curve upward drastically, yielding productivity increases beyond any that have been realized in the past. The shock wave image is important: It is essential to see how basic advances in agricultural science, like those in plasma physics, can move an entire sector of the economy and then the entire economy itself onto a new level of production.

Most observers, including U.S. Department of Agriculture research analysts, agree that out of several promising areas of scientific inquiry, there are three specific

breakthroughs that have this unique "shock" potential: (1) developing new photosynthetic capacities for plants; (2) understanding and controlling bioregulators, the chemicals that control plant growth and differentiation; and (3) increasing beef reproduction rates by twinning.

In the land-grant research and extension institutions, the broad-based and experienced research staff already exists and need only be expanded and supported by increased funding to carry out the required research. In addition, agricultural R&D results would have to reach American farmers in the early stages of testing new technologies, through generously funded extension services of the state universities and farm agencies, to ensure optimal development and use of new results and breakthroughs.

Let's look at each breakthrough area of research briefly.

### **Increased Photosynthetic Capacities**

The capture and transformation of solar energy by plants into foodstuffs is at about the 1 percent level for a large number of important crop plants. By increasing these photosynthetic capacities just to the 2 percent level, it is possible that twice the yield could be realized, thereby doubling the effective energy-throughput capabilities for a given area. Although this, of course, would require an increase in inputs, it would raise farmer productivity twofold.

This transformation in photosynthetic capabilities is not just a futuristic dream. Large differences in net photosynthetic efficiencies between C3 and C4 plants exist in nature on the order of 100 percent. (C3 and C4 refer to different metabolic pathways that are a basis of the photosynthetic efficiencies. The C3 plants include wheat, rice, soybean, potato, peanut, barley, sugar beet, and banana. See the comparison of maize, a C4 plant, and soybeans, a C3 plant, in Figure 2.)

One reason for the lower efficiencies of the C3 plants is that there is a much more rapid loss of the photosynthetically fixed carbon dioxide through the process of photorespiration; C3 plants photorespire at rates three to five times those of C4 plants. Part of the difference is explained by different metabolic pathways of the plants. Another hypothesis is that different anatomical makeups contribute to the differences.

Ongoing research to transform C3 plants into C4 plants is intense, involving basic genetic and anatomical questions. The attempts to solve the problem include protoplast fusion techniques, where individual cells with the different characteristics are denuded of their cell walls and joined together to form hybrid cells, hopefully combining the desired characteristics and genetic makeup; recombinant-DNA techniques, where the C3 cells to be transformed are "engineered" with genes from the C4 plant cells; and selection techniques, where C3 plants are treated with radiation or particular chemicals to increase their number of mutations, and are then grown out under conditions that allow the plants that have been transformed to the desired state to be selected out and subsequently used for crop growth.



Overcoming this genetic barrier would mean that such crops could be planted at increased densities and, with the corresponding increase in farmer inputs, could realize increased yields. This successful "overcrowding" would again mean an increased energy throughput for this area of agriculture and a substantial potential for increased overall productivity.

In another area, the availability of water for plant growth is one of the most fundamental problems for agricultural productivity. One solution to this problem lies in the development of plants capable of utilizing waters of increasing salinity. Various biological researchers are probing the question of salt tolerance in the hope of finding or creating useful plants that could use brackish or even saline water, thereby opening up large areas of currently marginal potential.

Research into the science of soil management also holds great promise for increasing yields, increasing the efficiencies of nutrient utilization, and aiding the management of water by increased absorptivity and retention. For instance, the addition of humic acid materials helps convert poor or marginal soil into productive land, while the addition of these materials to sandy soils appreciably enhances water availability for crop production. Additionally, experiments involving humic acid concentrates indicate increased crop yields, reduced chemical leaching from the soil, and reduced soil erosion. Research and on-site testing are required to refine and broaden the use of this and other soil-management practices.

Another point of research activity arises from the fact that the lack of substantial quantities of desirable nutrients, or of nutrients that are of high quality (such as those with balanced proteins), diminishes the usefulness of many of the world's crops. Creating plants that possess improved nutrient value would alleviate part of the current deficiencies.

Two examples of this are the attempted increase in lysine content in corn to give it a better quality protein and the successful creation of triticale, a hybrid of rye and wheat that has a protein content of 17 percent, compared to the 11 to 14 percent of wheat.

Two other promising technologies are hydroponics, or agriculture without soil, and aquaculture, or fish farming, a potentially rich source of protein.

Hydroponics is the growth of plants in an inert medium such as gravel or even plastic with a controlled exposure to a water-nutrient solution. Highly capital intensive, it holds great promise in that it is capable of achieving very rapid, intense plant growth rates while utilizing as little as 7 percent of the water required by conventional agriculture. Additionally, the necessary inputs of herbicides and pesticides are greatly diminished or even eliminated; fertilizer input is estimated to be 20 percent that of soil-based growth.

The potential of this method is that it gives the farmer complete control over the plant's environment. In the greenhouse the carbon dioxide content, the humidity, the temperature, and even the light intensity and duration, as well as the nutritional exposures, are all under man's

control. Yields threefold to fivefold that of normal agricultural practices can be achieved, along with the potential for automation of growth and harvest.

Depending on research funding, the use of hydroponics in the cash-crop area is probably not too far off.

Another possibility is aquaculture, an ancient practice going back thousands of years in the far Eastern countries. Traditionally, aquaculture has produced low yields and involved labor-intensive methods; however, recent developments have renewed the potential of this rich protein source.

Experiments at the Oak Ridge National Laboratories

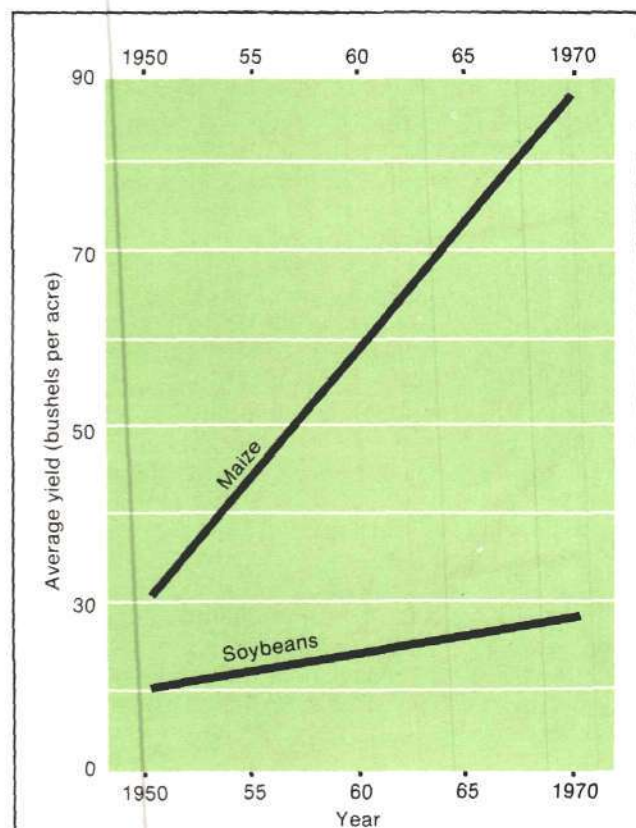

**Figure 2**  
**AVERAGE YIELDS PER ACRE OF MAIZE (C4)**  
**VERSUS SOYBEANS (C3) SINCE 1950**

Net photosynthesis in maize (corn grain) is more than twice as fast as in soybeans, resulting in maize yields double those of soybeans at high irradiance, as these U.S. figures show. Maize is a C4 plant, soybeans a C3. The increase in maize yields is partially a result of breeding varieties that can make use of increased nitrogen fertilizer applications. (Soybeans do not respond to nitrogen fertilization.) The low rate of soybean photosynthetic efficiency explains the biological barrier to increased soybean yield.

Source: I. Zelitch, "Improving the Efficiency of Photosynthesis," *Science*, May 1975.



**Table 2**  
**IMPACTS OF EMERGING UNPRECEDENTED TECHNOLOGIES ON U.S. PROJECTED AGRICULTURAL PRODUCTIVITY IN 1985, 1990, 1995, AND 2000**  
 (1967=100)

Year	Productivity index projections <sup>1</sup>	Productivity index adjusted for impacts of			
		Twinning	Bioregulators	Photosynthesis enhancement	All three technologies
1985	122	122	122	122	122
1990	130	130	130	130	130
1995	138	138	139	138	139
2000	145	147	149	146	151

1. With a 7 percent annual growth rate in research funding.

Shown here in terms of a productivity index is the impact of breakthroughs in twinning, bioregulators, and photosynthesis enhancement according to the projections of agricultural economists Lu and Quance. The baseline productivity index projections in the first column assume a 7 percent per year rate of growth of public research and extension programs, a rate of R&E funding significantly higher than today's. Therefore, although this was the average growth rate during the 1944-1950 period, and although it was surpassed during the 1956-1958 period, it is far more optimistic than the present situation. Each point of increase in the index is equivalent to \$1 billion in farm output.

in Tennessee have indicated possible yields of more than 25,000 pounds of fresh fish per acre per year, with the bulk of the inputs being sewage. An all-male, multiple-species system that optimizes temperature, fish densities, and delayed onset of sexual maturity were the experimental factors used to project this yield. The costs are competitive with current traditional fish costs, less costly in terms of energy use, and less labor intensive than current fishing practice.

Ongoing biological research to further maximize growth rates, disease-resistance, and so on, should make this a major source of protein in the near future.

### The Negentropy Factor

Just beyond the specific research areas identified here are the basic research areas in the related fields of biology, agriculture, and medicine. The fundamental principle of the biosphere involved in all these disciplines is the increase in the rate of generation of *negentropy*.

What is ultimately most important in agriculture as well as in human-reproductive practice is not the growth of output or per capita energy use as such, or even the increase of productivity or of energy intensity—although these are all necessary features. Rather, most important is the series of qualitative transformations of the state of organization of the biosphere as a whole that is produced by breakthroughs in physics and biology research. When such breakthroughs, whether in nuclear physics or genetics, are applied as new technologies, they produce an increase in the rate of increase of energy flux density and per capita energy consumption in the human ecology. The increase in thermodynamic free energy subsuming these processes is the characteristic of *negentropy*.

An example from recent biological research illustrates this concept.

In contradiction to the fundamental tenets of Darwinian and Mendelian genetics that underlie most basic and practical biological research, critical experiments in both plants and animals have demonstrated "nongenetic" transformations that have proven inheritable. Such transformations indicate higher-order geometrical qualities for genetic material other than simple coding. These transformations are not based on hybridization-selection techniques, nor do they result from DNA mutational events.

For example, in response to a particular array of environmental stimuli, young flax plants undergo a qualitative transformation in size that has proven hereditary over many generations even though the original stimuli are no longer present. Additionally, the DNA content is increased in the cells of the transformed plants. Under certain conditions this DNA level reverts to the previous, non-transformed level, but the plant size remains at the transformed, large size.<sup>1</sup>

This group of experiments indicates that the qualities of genetic material are not located in fixed molecules, but that they reflect an interaction of the totality of cellular constituents within a changing ecology. This interaction is geometric in nature; that is, individual genes are reordered to assume new qualities within new organizations that, in turn, reflect the larger interacting ecology.

This viewpoint, in fact, has been fully confirmed by other broad-ranging research demonstrating that the evolution of new species is not attributable to random mutations, but rather to large-scale genetic reorganization.<sup>2</sup>

The importance of these findings for agriculture and all



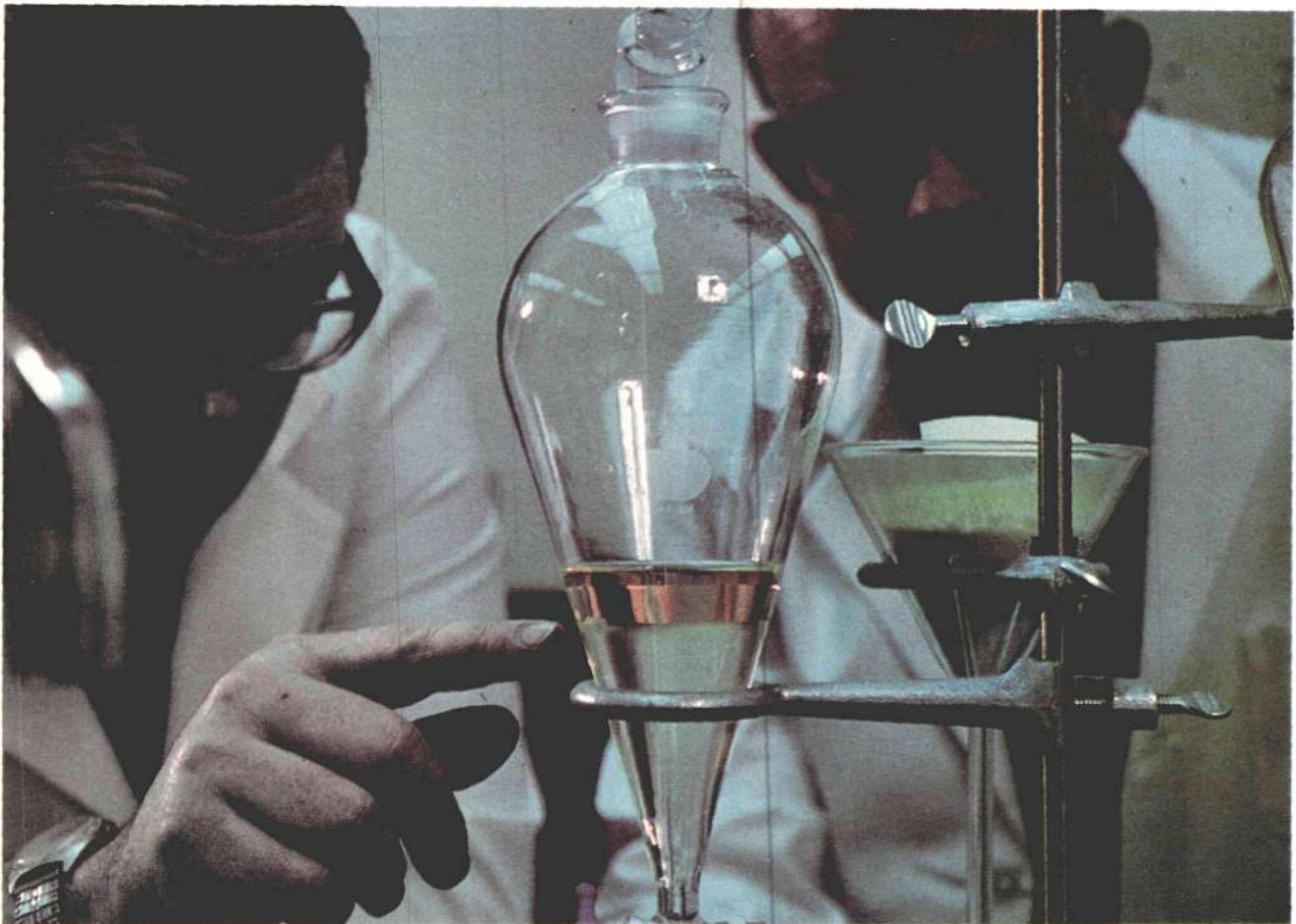

Research and extension funding is the most important factor in determining the future of agricultural production. Here a research chemist separates impurities from corn extract. USDA

other biologically related practices cannot be overestimated. It allows for research that maximizes energy throughputs and for the directed development of successively higher-ordered ecologies. Just as current agricultural practice has tended toward increased energy use with more efficient varieties of plant life and has altered species dominance to develop ecologies that represent higher levels of negentropy, future experiments based on genetic and cellular research like the flax transformations will further revolutionize agricultural activities.

#### **The Economics of Agricultural Research**

The expansion of properly oriented research and extension (R&E) activities as outlined here will ensure agriculture's future prosperity in the same way that such activities in the past have made U.S. agriculture the world's most productive and most profitable.

The relationship between R&E, productivity, and profits can be made quite specific. Recently an Agriculture Department team studying productivity showed that R&E funding is the most important factor in determining future agricultural productivity.

As stated by Lu and Quance, agricultural economists in

the U.S. Department of Agriculture, in their study, "Outlook for Technological Change and Agricultural Productivity Growth Through the Year 2000": "Research and extension expenditures are perhaps the most important variable which public decisionmakers can control in influencing long-run growth in agricultural productivity. It frequently takes years to develop new technologies; once developed, they must be adopted by farmers in order to affect productivity. The adoption rate depends on extension activities, which disseminate technical information to farmers, and on the educational attainment of farmers."

The study found that a 1 percent increase in R&E expenditures in a given year will raise agricultural productivity by a total of 0.037 percent or about \$37 million over a 14-year period, with the peak impact occurring approximately six years after the expenditure increase. The Quance study has also estimated that a 1 percent increase in the farmer education index will increase productivity by 0.08 percent.

A 1 percent increase in productivity is equivalent to over \$1 billion. To translate this into a dollar payoff: Generous estimates indicate that the total amount spent on agricultural R&E annually is about \$1 billion (govern-



ment funding here is approximately matched by the private sector). Therefore, a 1 percent increase in research expenditure—or \$10 million—pays itself off in less than four years and realizes a return more than 3.5 times that investment over the 14-year productivity cycle.

Perhaps most interesting, given the current state of R&E funding, and the program proposed here, are the specific results the Quance study predicted for agricultural productivity if the technological advances outlined above were developed. To measure such results, the Quance group computed an "agricultural productivity index," a complex measure of agricultural output relative to the total labor and material input. Table 2 shows how so-called unprecedented technological advances—livestock twinning, bioregulators, and enhanced photosynthesis—would increase the productivity index much faster.

The Quance group found that by the year 2000 the productivity index increases from the 1985 level of 122 to 145. Under the impact of the "technological shocks" of twinning, bioregulators, and photosynthetic enhancement, the productivity index increases to 147, 149, and 146, respectively, and for the realization of breakthroughs in all three areas it increases to 151, which is equivalent to more than a \$7 billion increase in productivity.

It is important to note that the results hypothesized in the indexes put forth by the Quance study are necessarily conservative in that they hold constant all the parameters that contribute directly and indirectly to the increased wealth that any single breakthrough—or all three breakthroughs—would make. Although they term the effects of these breakthroughs "shockwaves," in actuality the postulated effects are linearly incremental quantitative changes and not the nonlinear, qualitative changes that characterize a true shock-wave phenomenon. An actual shock-wave phenomenon would produce an entirely new geometry for the relationship between agricultural research and productivity and the overall functioning of the economy.

For example, the water and energy inputs to agriculture that are described in the preceding article would greatly increase the effective results of the breakthroughs in twinning, bioregulators, and enhanced photosynthesis. This, in turn, would so increase the real wealth and total free energy of society that further improvements in the form of increased infrastructural projects and technological innovations would be achieved much more quickly.

Although these results would be significant in the advanced sector, the effects of large-scale hydrological and

## Agricultural R&D: The U.S. Versus The Soviet Union

*A dramatic indication of the dangerous drop in U.S. agricultural research over the past decade can be seen by comparing U.S. investment in this area to Soviet investments in agriculture. Here are excerpts from an editorial on the subject in the April 18, 1980 issue of Science by Sylvan Wittwer, director of the Michigan State University Agricultural Experiment Station in East Lansing.*

**N**owhere is the gap [between the United States and the Soviet Union in investments in research and development] widening more rapidly than in the area of investments in agricultural research. Reports in the mid-1970s suggested that one-third of the world's agricultural research was conducted in the United States. This is not true in 1980. There are now more than 60,000 agricultural scientists in the Soviet Union and more than 150,000 supporting personnel. They man 48 agricultural experiment stations and 175 research institutes.

By comparison, there are around 12,000 agricultural scientists in the United States receiving public support . . . and a nearly equal number from the industrial sector and others outside the land grant system: a total of 25,000 for the nation.

The number one agricultural research priority in the Soviet Union is stability of production. . . .

Soviet scientists are world leaders in wheat genetics (they have moved winter wheat production 200 miles farther north), the development of high-yielding hybrid dwarf sun-

flowers, and research to reduce environmental stresses on crops and livestock. Expenditures beyond those in the United States are being made for research on photosynthesis, genetic improvements in crops and livestock, forage production, water management, and the soil sciences. There are 21 centers for animal breeding, and institutes in every republic for mechanization, soils and fertilizers, and pest control. . . .

One single advantage of the U.S. agricultural system over the Soviet system is a climate that dependably produces an abundance of crops and livestock. That advantage can be overcome in time by the significantly greater technological inputs now directed by the Soviets into the management of resources, their genetic improvement programs, and their research emphasis on control of the basic biological processes that limit the magnitude and stability of crop production. . . .

Meanwhile, the share of total R&D expended for agricultural research in the United States has fallen from 39 percent of the total in 1940 to 2 percent in 1980.



nuplex development in the Third World would make the rate of realized increased return on scientific efforts that much more dramatic. And in the longer term, for both the advanced and the developing sectors, breakthroughs in research on ordered plasmas and the fundamental nature of biological matter, making technologies like hydroponics economical, will truly revolutionize agriculture.

### U.S. Farm Policy: Devolution?

Just as breakthroughs in scientific research will "shock" the productivity curve upward, so the current trends in U.S. research funding over the past several years—from basic research projects and the development of new technologies to research aimed at cutting costs of production, biomass energy development, and sociological studies—will tend to have the effect of "shocking" the productivity curve downward.

A look at the agricultural research funding and policy of the U.S. Department of Agriculture shows alarmingly that the administration has chosen this downward course, despite the dollars and cents policy guidelines developed by the Quance group to move U.S. agriculture upward.

Under the fiscal year 1981 budget proposed by President Carter, the U.S. Department of Agriculture would receive \$786 million total for research. This is a nominal 5.8 percent increase over the previous fiscal year, but a significant cut in real terms, given inflation.

Furthermore, within the overall budget during the 10 years from 1969 to 1979, there was a 10 percent decline in the funding committed to basic agricultural research by the U.S. Department of Agriculture. As one researcher at the Department of Agriculture's Beltsville, Maryland center put it to *Business Week* magazine in 1975, "When a scientist retires, he isn't replaced, so we don't get any new blood." And during the same period, private industry spending on basic research dropped by 23 percent.

The philosophy behind this destructive trend has been elaborated many times over by U.S. Agriculture Secretary Robert Bergland. For example, Bergland has opposed the funding of mechanization research and, indeed, mechanization itself. In the case of the mechanical tomato harvester, which has increased tomato production and eliminated thousands of dehumanizing, stoop-labor jobs in California, Bergland said in January 1980, "We will not put federal money into research where—other factors being equal or neutral—the major effect of that research will be the replacing of an adequate and willing workforce with machines." Too much emphasis has been placed on the value of productivity gains from new farm technology, he added.

Accompanying this attempt to reestablish labor-intensive agriculture in the United States is an increased amount of funding for research into organic farming. Under the guise of being healthier and less energy wasteful, the Bergland forces are giving the organic farming practices legitimate treatment in the Department of Agriculture and directing research monies into this area. This is despite the acknowledged drop in both total yield and labor



USDA

Secretary of Agriculture Bergland: Overmechanization?

power that is usually the rule for these farming practices—practices that translate into higher consumer prices.

Equally exemplary of the degradation of agricultural research is the recent emphasis on backward and inefficient technologies such as energy from gasohol, biomass, or solar. Secretary Bergland has set up a special office within the Department of Agriculture to promote biomass, and relatively significant amounts of funds have been channeled into solar research—both sources that are compatible only with high energy prices and restricted outputs.

Although gasohol might have limited use on the farm site, using what would otherwise be discarded waste material, its widespread use as an energy source would be economically disastrous, as agricultural studies have demonstrated. Researchers at Ohio State University School of Agriculture, just to take one example, have shown that it is much more economically productive for farm land to absorb energy and produce crops instead of growing inefficient energy raw materials.

The research tasks ahead to turn this situation around are clearly defined and within reach. The U.S. farm sector can create the shock waves necessary to revolutionize world agriculture; the obstacles are not scientific but political.

*Dr. Pollak, a molecular biologist, is the biology news editor of Fusion.*

#### Notes

1. Richard Pollak, "Evolution—Beyond Darwin and Mendel," *FEF Newsletter*, May 1977, p. 42.
2. Carol Cleary, "Evolution: A Riemannian Approach to Biology," *Fusion*, Vol. 3, No. 6 (March 1980), p. 48.



# The Great Pesticide Hoax

When U.S. Environmental Protection Agency chief William Ruckelshaus was about to announce his decision to ban DDT in June 1972, he confided to a friend, "There is no scientific basis for banning this chemical—this is a political decision."

The politics of the DDT decision were part of an environmentalist onslaught against American leadership in scientific agriculture that is still in force. On March 1, 1979, the EPA issued a ban on several critical uses of the herbicide 2,4,5-T. The EPA now admits that the evidence upon which it based the ban is invalid. But the agency has not rescinded the ban; it remains in effect indefinitely. Furthermore, the EPA is currently holding hearings on instituting a total ban.

The chemical 2,4,5-T has been used for more than 30 years with an unexcelled safety record. The serious danger that does exist at this point is the danger of *not* using 2,4,5-T. There is no adequate replacement for this and related herbicides in forestry, grain and livestock production, or rights-of-way maintenance.

A second EPA target for banning is the herbicide 2,4-D, which is equally harmless to humans (it is known to homeowners as the best dandelion killer). Such pesticides are vital to America's health and well-being, for they act to increase production, decrease labor and capital requirements, and keep disease-causing organisms in check.

Both 2,4,5-T and 2,4-D are phenoxy herbicides (see figure). They are used mainly for weed and brush control, allowing the maximum growth of the desired crop plants and the elimination of undesirable plants. Although the exact mechanism by which these herbicides work is not fully understood, they appear to affect the regulation of





growth processes that are usually controlled by the plant's natural growth hormones. Cell division and enlargement, food utilization, and several other vital processes are adversely affected in the susceptible plants, thereby eliminating them and leaving conditions more favorable to the crops, forest trees, range grasses, and other preferred species. At the small doses applied, these plant-specific chemicals have virtually no effects on animal physiology.

### No Feasible Alternatives

For all practical purposes there exist no alternatives to the use of phenoxy herbicides for the control of broad-leaved weeds in grain production. Mechanical or hand tillage is not a realistic possibility and other herbicides are less selective and more toxic than the phenoxies. For example, it is estimated that as much as a 33 percent reduction in wheat yields could result if 2,4-D were not used where wild mustard is prevalent. With the use of herbicides, weed infestation cuts rice yields by 8 percent and quality by 4 percent; without 2,4,5-T use, rice yields are reduced by about 40 percent.

Both 2,4-D and 2,4,5-T are of great importance in forestry as well. Estimates are that three-fifths of commercial forest is producing at well below capacity, mostly as a result of competing vegetation.

Although there are alternatives to the use of the phenoxy herbicides in this situation, they carry increased dangers and destructive side effects. For instance, mechanical weed control is far more dangerous for the workers involved; insurance costs based on accident rates for the management of forest land are 20¢ per acre for spray treatment and \$16 for mechanical care. Also, mechanical care costs are far greater, ranging from \$32 to \$156 per acre compared to \$15 to \$23 per acre for herbicide treatment. The amount of labor necessary to manually cut the 500 million acres of productive forest also makes this an unfeasible option.

Another option is the use of fire to control the undesirable vegetation. In addition to the obvious problems of air pollution and the destruction of wildlife, the problem of control makes fire far less desirable for enhancing forest productivity.

The U.S. Department of Agriculture has estimated that the ban on 2,4,5-T will reduce timber growth over the next 50 years by 18.3 billion cubic feet, which translates into 9.3 million new homes lost to the United States. According to National Forest Products Association estimates, the ban will cost Americans more than \$12 billion.

The use of the phenoxy herbicides is also critical to the maintenance of range and pasture lands. A grazing animal selectively eats forage plants and leaves weeds untouched, giving the weeds a huge selective advantage, often to the point where without weed control they soon overrun the feed plants. In addition to limiting available feed for the livestock, it is estimated that 3 to 5 percent of domestic livestock are killed annually in the United States from the consumption of poisonous plants; without control of these plants the number of livestock killed would be significantly higher.

---

*'The total value of DDT to mankind is inestimable, and is comprised of nutritional, economic, and social benefits.'*

Clifford M. Hardin,  
Secretary of Agriculture,  
Aug. 31, 1970

---

Rights-of-way refers to tracts of land used by the utilities, railroads, and highways. Although most are initially cleared by mechanical means, control is usually maintained by phenoxy herbicide use. The alternative control methods suffer the same problems as those indicated for farmlands and forests.

### The Scientific Questions

The emergency suspension issued by the EPA against the use of 2,4,5-T in pasture, forests, and rights-of-way followed the investigation into the possible causal relation between spontaneous abortions (miscarriages) in humans and the use of the herbicide in forests in western Oregon. This EPA investigation resulted from claims by eight women living in Alsea, Oregon that such a relationship existed. The EPA's initial investigation concluded that "there is no real evidence of an epidemic based on the data presented."

Not satisfied with this conclusion, however, the EPA began a second investigation, "Alsea II," and concluded that there was sufficient evidence to ban the chemical, which it promptly did. This decision was made despite the fact that EPA hearings were already underway to investigate more fully all aspects of the use of 2,4,5-T in order to make a judgment about all uses of the chemical, based on the health effects, economic considerations, possible alternatives, and so on.

Subsequent to the ban, further studies by a variety of groups have conclusively demonstrated that Alsea II has no scientific validity.<sup>1</sup> But although the EPA admits the shortcomings of Alsea II, it has not lifted the ban. These studies include an extensive analysis by the Environmental Health Sciences Center of Oregon State University, issued on October 25, 1979. In this study, a group of scientists including an environmental chemist, an agricultural chemist, a toxicologist, three statisticians, and an epidemiologist concluded, "Our critique does not support any of the three conclusions from EPA's Alsea II study" and "the original contention of the women from Alsea, Oregon, namely that there is a relationship between herbicide use and miscarriages, is not supported by the data in EPA's Alsea II Report."

### The Dioxin Question

Despite the fact that 2,4,5-T has been used safely for more than 30 years, some laboratory studies and certain *unverified* anecdotal testimony have led to questions regarding its side effects. These are not centered on 2,4,5-T itself but on a miniscule contaminant formed in



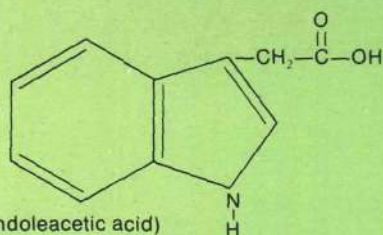

(a) Auxin (Indoleacetic acid)

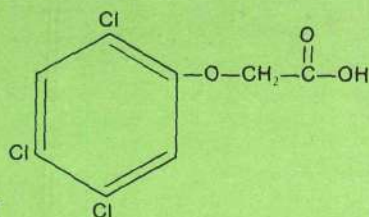

(b) 2,4,5-T

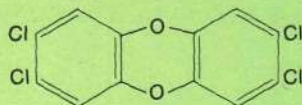

(c) TCDD (Dioxin)

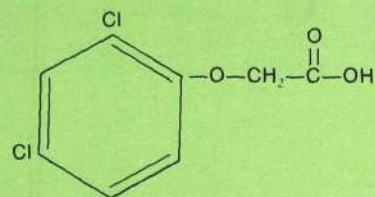

(d) 2,4-D

### PHENOXY HERBICIDES

Phenoxy herbicides are used to provide highly specific weed control. Applied at proper concentrations, they work by interfering with the regulation of normal growth processes by mimicking some of the effects of the natural plant hormone auxin (a). This leads to unbalanced growth and the eventual death of the undesired plant.

2,4,5-Trichlorophenoxyacetic acid (b) has been under partial EPA ban since March 1979. Although 2,4,5-T itself is not considered dangerous, a trace contaminant 2,3,7,8-tetrachlorodibenzo-p-dioxin [TCDD, or dioxin (c)] is considered highly toxic. But its toxicity at the minute levels present in the herbicide has never been demonstrated, and all studies have proven the pesticide completely safe for agricultural use.

2,4-Dichlorophenoxyacetic acid [2,4-D (d)], the first modern herbicide used, was discovered in 1944 and is generally acknowledged to be totally safe. Nonetheless, based on anecdotal reports, the EPA is considering holding hearings on its continued use.

its manufacture, TCDD (2,3,7,8-tetrachlorodibenzo-p-dioxin), known as dioxin.

Dioxin is a toxic chemical that has been shown to be carcinogenic in laboratory animals, albeit at doses far exceeding those likely to be ingested by humans. However, there is solid evidence that even this supposedly deadly contaminant is less dangerous than presumed, especially under practical-use conditions. First, the amount of dioxin in commercial 2,4,5-T is about 1 part in 100 million; at this concentration a single toxic dose of dioxin would be found in about 1000 toxic doses of 2,4,5-T, which is the amount applied to hundreds of acres of crop land at usual application rates. In fact, the total amount of dioxin is about 1 ounce per year in the entire United States; that is, a total of only 1 ounce is present for more than 5 million acres.

Furthermore, the dioxin is very rapidly decomposed by sunlight, most of it decomposing in the first 24 hours after application. According to the Council for Agricultural Science and Technology Report No. 77 (Aug. 1978), "amounts of TCDD sufficient to cause direct toxicity or birth defects . . . have never been found in food or water as a consequence of proper herbicide spraying."

There are several other strong indicators that the supposed dangers of dioxin are highly exaggerated. In an

accident at an industrial plant in Nitro, West Virginia in 1949, many workers were exposed to high amounts of dioxin, some at levels severe enough to develop chloracne (a skin condition that develops at very high doses). A 30-year medical evaluation of the 121 workers who developed chloracne was published this year: "It is important that no apparent excess in total mortality or in deaths from malignant neoplasms or diseases of the circulatory system were observed in [these] workers . . . followed over a period of nearly 30 years."

Another industrial accident at Seveso, Italy in 1976 exposed more than 35,000 people to varying amounts of dioxin. The total dioxin released is estimated at about 1.5 to 3.7 pounds over an area of 6 square miles, a concentration several millionfold greater than that of U.S. agricultural applications. Although the dioxin at Seveso was for industrial purposes and was not related to 2,4,5-T, the incident provides useful information on the effects of the chemical on humans. A recent study on this incident reported that no miscarriages, birth defects, neurological damage, psychological changes, nor a host of other diseases could be attributed to TCDD. Even more convincing is the fact that chromosomal studies on the Seveso population have shown no evidence of abnormalities.

Myriad other medical and ecological studies conclude



that 2,4,5-T is a safe and valuable pesticide. A meeting of concerned scientists, including those representing environmental groups, was held in Virginia in 1979. Among their conclusions are the following: "2,4,5-T is not a carcinogen nor mutagen in animal test systems studied to date"; "Phenoxy herbicides containing TCDD have not been shown to be carcinogenic in humans in retrospective epidemiologic studies to date"; and "Analysis of the available data [from the United States, Sweden, New Zealand, Australia, Vietnam, and Italy] leads this group to the conclusion that no adverse effects on human reproduction have yet been demonstrated after exposure to 2,4,5-T or TCDD."

The Scientific Advisory Panel, authorized by the U.S. Congress to advise the EPA on suspension or cancellation actions, reached a similar conclusion: "After extensive review of the data we find no evidence of an immediate or substantial hazard to human health or to the environment associated with the use of 2,4,5-T or silvex on rice, rangeland, orchards, sugarcane, and noncrop uses."

### Agent Orange

The pesticide scare has been fueled by recent controversies over "Agent Orange," one of several pesticide cocktails used by the U.S. Armed Forces in Vietnam to defoliate large areas in order to deprive the Vietcong of food and cover. In addition to Vietnamese complaints of chemical poisoning, U.S. Vietnam veterans have claimed that a multitude of symptoms are the result of exposure to Agent Orange.

There are several reasons to doubt that Agent Orange is the basis of their problems, however. Perhaps most important is that none of the affected individuals showed the primary symptom of dioxin poisoning—namely, chloracne. If it were the case that their afflictions were caused by the chemicals in question, it would be extraordinary that the usual symptoms associated with these substances were not present but wholly new and disparate pathologies were generated.

The National Academy of Sciences Committee, commissioned by the Department of Defense with funds appropriated by Congress, thoroughly investigated this question. Its final report stated that "The Committee could find no conclusive evidence of association between exposure to herbicides and birth defects in humans."

Furthermore, the difference in composition and use of Agent Orange, especially with regard to the amount of dioxin present, makes comparisons between the chemical warfare agent and agricultural 2,4,5-T pesticides an absurdity. The amount of dioxin present in the Agent Orange used in Vietnam was from 100 to 1,000 times that present in the commercially used 2,4,5-T today, and the application dosages of the herbicide were more than 30 times that used for agricultural purposes. This means that the dioxin exposures in Vietnam were at least 3,000 to 30,000 times that of a farmworker in the United States today, making claims for the relevance of chemical warfare experiences to that of the U.S. population untenable.

Some of the opponents of pesticides have a remarkable

ulterior motive. In 1979, when 2,4,5-T was banned, it happened that the second largest commercial crop in Humboldt County, California was marijuana, with a net value of \$93 million. This crop was produced not by a hippie commune, but by a large, well-run commercial venture tied to international drug-traffic interests. The Humboldt County Board of Supervisors this year voted to reject a Law Enforcement Assistance Administration grant for aerial spraying of 2,4-D to eradicate the marijuana, which as a broad-leaved plant is susceptible to the effects of 2,4,5-T and 2,4-D.

It is well documented that environmentalist groups and groups that advocate drug use have a history of mutual support activities, including the fact that the Playboy Foundation funds NORML (the lobbying group for decriminalization of marijuana) and the American Friends Service Committee (a leading opponent of nuclear energy) and the fact that the environmentalist Friends of the Earth actively assisted NORML's attorney Keith Stroup when he successfully filed a lawsuit to prevent the U.S. State Department from funding Mexico's program to eradicate marijuana—a suit invoking EPA laws.<sup>2</sup>

### Life Without the EPA

If the U.S. agricultural producer were free from EPA strictures to use the tools of herbicides, insecticides, and fertilizers to turn a devolving countryside into a flourishing and productive garden, none of the environmentalist scare stories would come true. Despite the cancer scare headlines, heavy use of agricultural chemicals would not cause epidemics of disease and malignancies.

We can say this assuredly based on, first, the nature of the chemicals that would be produced and used, and, second, the history of the past 75 years in the United States.

The best pesticides are usually the most innocuous to humans. The effectiveness of the substance is in direct proportion to its specificity; any substance that is too broad in its mode of action or in the sphere it affects is likely to be relatively less useful to the farmer and thus less likely to be a successful product for the chemical companies.

Furthermore, any chemical that is not highly specific requires even greater care in its use to be beneficial to the farmer; any farmer worth his salt will use it carefully or will not be successful enough to continue to farm.

What this means is that the policies of the EPA are most likely to accelerate the ecological problems the agency ostensibly exists to head off. EPA's constant attacks on the most successful (and, lawfully, the safest) chemicals are resulting in two related effects: the diminished availability and use of the best pesticides and the increased use of labor-intensive practices. This, in turn, has led to decreasing productivity, increasing costs, and ultimately the shrinking of the basis for future production. Historically, these conditions—increased pestilence and the concomitant decrease in societal wealth—have been the basis of an ecological holocaust.

The history of the United States since 1900 also proves



the *opposite* of the *raison d'être* of the EPA: Industrial development has improved U.S. health. The increased use of science and technology by a culturally advanced population is of the highest positive value, resulting directly in the increased standard of living enjoyed by the population. This is exemplified by the increase in life expectancy (from 45 years old in 1900 to more than 75 years today), the decrease in every major disease category, and the increased availability of a nutritious diet.

Even the heart of the environmentalist argument, that the United States is in the midst of a cancer epidemic, is an outright lie. The fact is that, except for lung cancer—which is directly attributable to smoking, there has been no increase in the incidence of cancer since 1900, once the increase in the size of the population and the shift in the age range of the population (a result of increased life expectancy) are accounted for.<sup>3</sup> This fact is of the greatest importance, for it destroys the present justification of the agencies and rules created by the neo-Malthusian policymakers to protect the population from industrial society.<sup>4</sup>

What would life be like without the EPA? The American farmer could make full use of DDT and phenoxy herbicides and get back to his professional use of modern technology to feed a growing world.

—Dr. Richard Pollak

#### Notes

1. Aisea II was also criticized by the June 1979 Scientific Dispute Resolution Conference on 2,4,5-T, which wrote: "The miscarriages reported in this study were not demonstrated to result from the spraying of the forests with 2,4,5-T," and "The group found no evidence for an abortifacient effect of TCDD in the human."  
*Lancet*, the British medical journal, wrote, "Independent statisticians have been unable to find any evidence in the data of a link between abortion and 2,4,5-T...."
2. For ongoing coverage of the connections between the marijuana lobby and the environmentalists, see the magazine *War on Drugs*. The connection is also discussed by the man who invented LSD, Albert Hofmann, in his book *LSD: My Problem Child* (New York: McGraw Hill, 1980), especially pp. 174-176.
3. The case is made in full detail in "There Is No Cancer Epidemic" by this author, *Fusion*, Aug. 1978, p. 40.
4. Do the environmentalists waging the antipesticide campaign understand the consequences of what they are doing? Here is a recent comment on the subject by life-long Sierra Club member Thomas Jukes, a professor of biophysics at the University of California, Berkeley: "... I watched the transition take place in environmental groups from an outdoors movement that was dedicated to preserving wilderness... to a broad-based antitechnological movement led by professionals.... The long-term goal of environmentalism is the elimination of advanced technology, including agricultural technology.... The [Audubon] Society shows underlying resentment of human beings and all their works, including cities, farms, highways, and especially private industry. Membership in the society is a form of expiation of the sin of being one of the human race, the species that consumes 'the environment.' The society stated recently that one of its two main purposes is 'the education of man regarding his relationship with and his place within the natural environment as an ecological system.' This pious pronouncement is actually intended to exclude man as an inhabitant of the Earth, except in small numbers and in a primitive, mythical, aboriginal state."

## DDT: The Facts Versus the Myths

The 1972 ban on the use of DDT in the United States culminated the initial phase of the environmentalist onslaught against America's positive role in scientific industry and agriculture. This ban was based on lies and distortions disseminated by the environmentalists, including the Environmental Defense Fund, the Audubon Society, and Rachel Carson.

There was *no* scientific evidence that warranted the banning of DDT. As the U.S. Public Health Service noted in its recommendation to the EPA Sept. 9, 1971: "The known health hazard from DDT is essentially zero. Examined in this light,

the benefits to mankind from the use of DDT for the control of malaria far outweigh even any potential hazard." In fact, official statistics showed that DDT use helped to control human disease so effectively that entire populations were freed to live productive lives. Similarly, DDT contributed to insect control so effectively that food production increased by as much as 40 percent.

Long-term studies have shown that DDT is so safe to humans that doses 100 times as strong as those that occurred in periods of widespread DDT use have had no ill effects. Equally demonstrable, the consequence of the ban was an immediate rise in human death and debilitation from the diseases that DDT had effectively controlled—malaria, typhus, plague, yellow fever, encephalitis, spotted fever, sleeping sickness, and others.

Most incredibly, the Environmental Protection Agency banned DDT after months of hearings in which reputable U.S. and world health agencies all testified against

the ban, presenting sound scientific evidence. On the other hand, the environmentalists presented evidence characterized by poor experiments, dubious theory, and just plain lies.

Contrary to environmentalist allegations, the success of most bird species during the DDT years is obvious to anyone who spends much time outdoors. The charge that DDT never breaks down chemically has also been demonstrated to be untrue.

The environmentalist charges linking DDT to cancer are generally an embellishment on one study that indicated that DDT can induce liver tumors in mice. But further investigations indicate that DDT may actually be a cancer inhibitor.

The EPA and environmentalists must be held accountable for their crime: There was not a single human death from DDT usage; there have been untold thousands of deaths and millions of disease-stricken persons as a result of the DDT banning (see *Fusion*, June 1979, p. 60).





# Doing Something About the Weather

NASA

Satellite photograph of hurricane over the Pacific.

## *The Role of Plasma Physics*

by Dr. Steven Bardwell

**R**ecent work in plasma physics has shown an extraordinary, unexpected similarity between the dynamics of high-energy plasmas and the long-time behavior of the earth's weather. There had been speculation by many scientists that such a similarity should exist. Both systems are characterized by highly nonlinear interactions that for both dynamic and kinematic reasons give rise to large-scale, ordered structure on the longest time scales dominating the evolution of the systems.

Now A. Hasegawa and his collaborators<sup>1</sup> have demonstrated that the mathematics and physics governing the most important turbulence in magnetized plasmas of fusion interest (called drift-wave turbulence, wave energy in plasma modes involving crossed magnetic fields and density variations) and the dominant wave behavior of large-scale atmospheric

## *How Weather Systems Work*

by Lyndon H. LaRouche, Jr.

**I**t is not the weather that determines the conditions for life. It is life that has created and maintains the weather systems. In other words, weather is not an inorganic physics matter; it is a by-product of a highly organized living process. . . .

In addition to coriolis forces and other factors normally contemplated by meteorologists, the creation and maintenance of a stable high-pressure system are determined by the respiration of moisture from plant life. This column of moisture, although relatively a small portion of the total energy involved in a weather system, affects what are called long-wave patterns in the atmosphere. The result: in a manner consistent with the geometrics of least action, the columns of moisture rising from plant life pin major weather systems into place. By

*Continued on page 58*





Tornado in Manhattan, Kansas May 31, 1949.

USDA

motions (Rossby waves) are governed by the same equation and exhibit similar tendencies toward the formation of large-scale vortex motion when the waves "break."

Hasegawa showed that the dynamics in both cases are dominated by the similar dispersion properties of the waves involved; that is, the way in which wavelength varies with frequency. In both cases the waves have a dispersion relation indicating that it is energetically favorable for a mixture of the waves to evolve toward concentration at longer wavelengths. This "inverse cascade" is opposite from the normal tendency of turbulence to transfer energy to shorter scales, usually generating increasingly disordered motion.

Hasegawa's research showed that in both the plasma and the meteorological cases, the spectrum of wavelengths evolves toward larger scales. In the atmospheric case this results in the formation of "geostrophic vortex motion," that is, the formation of large-scale, long-lived atmospheric vortices on the scale of thousands of kilometers. In the plasma case, this

## Weather Systems

*Continued from page 57*

the same least-action principle, a substantial shift in the pattern of such vapor ascension results in a shift of the weather system.

So, as a direct result of the Brazilian substitution of biomass for fossil fuels, the Amazon High shifted out over the Atlantic, causing catastrophic shifts in the rainfall patterns in Brazil and throughout the Caribbean region. The shift also caused—billiard-ball fashion—a general shift of weather systems globally.

Two other cases should be cited as illustrations. These are the ongoing desertification of the Sahel region of Africa and the recent years' rise in the average temperature of large parts of India.

Under the pressure from the same sort of bankers who dictated the biomass-substitution policy to Brazil,

*'It is not the weather that determines the conditions for life. It is life that has created and maintains the weather systems. Weather is not an inorganic physics matter; it is a by-product of a highly organized living process.'*

debt-ridden African nations sought to increase their tax receipts from the most primitive forms of labor-intensive agriculture and pastoral tribes. This meant accelerated depletion of the soil—under labor-intensive modes lacking in the compensatory benefits of irrigation and fertilization.

It meant extensive overgrazing of the band of brush along the Sahara side of the Sahel.

The reduction in biomass in these regions meant a reduction in plant-produced vapor. The weather patterns in much of the Sahel shifted, resulting in a pattern of self-aggravating desertification.

In India, the direct cause of an oppressive rise in mean temperature is the large-scale deforestation caused chiefly by the substitution of biomass for combined hydroelectric, fossil-fuel, and nuclear requirements.

It is the conversion of solar energy into the organized vapor and biomass of forests and agriculture (principally) that regulates not only rainfall patterns, but the climate generally.

### **Morally Acceptable Weather Control**

The management of global and regional climates in a manner consistent with climate and food requirements must be focused on improving the



evolution toward longer wavelengths results in the formation of circulation cells, spontaneous magnetic fields, and filamentary structures.

In the case of laser-created plasmas, Hasegawa notes that these magnetic spiral filaments are formed by a process very similar to the baroclinic instability in the atmosphere that is responsible for smaller-scale, more intense vortices like tornadoes.

#### FEF Climatology Model

Based on a similar, independent analysis of the formation and dynamics of geostrophic vortex motion, researchers in the Fusion Energy Foundation have developed a computer model of global dynamics. A preliminary study indicates, for example, that the destruction of Brazil's rain forest by appropriate technology has shifted the Amazon High out over the Atlantic, with worldwide repercussions.

Plasma and weather dynamics are two fields normally considered so dissimilar, given their tremendous differences in time scale (months for the atmosphere, fractions of a second for a fusion plasma), length scale (hundreds of kilometers for the at-

mosphere, mere centimeters for a fusion plasma), and energy density (different by a factor of millions), that it is truly extraordinary that they should share the same basic physics.

They also share an urgent societal need for their understanding and mastery, because energy and weather determine the life and death of humans more than any other areas of physics. Especially in drought-stricken areas where insufficient energy investment in agriculture results in desertification, which in turn dramatically weakens the geostrophic vortex motion whose energy source is water transpiration, leading to further drought, the mutually reinforcing effects of energy and weather are apparent.

A broad-based commitment to fusion research would provide a powerful theoretical and practical impetus toward solving energy problems and controlling the earth's weather.

#### Note

1. A. Hasegawa, M.Y. Yu, P. Skukle, and K. Spatschek, *Phys. Rev. Lett.* 41, 1656 (1978); A. Hasegawa and C. MacLennan, *Phys. Fluids* 22, 2122 (1978).



NASA

Plasma vortex formed in a laboratory experiment.

energy intensity of large tracts of crop production plus a combination of extensive forestation and energy-intensive biomass production along coasts as an adjunct of a general shift from ocean fishing to fish-farming.

For example, we can bring back the Sahel and make the Sahara itself fruitfully habitable eventually by a combination of irrigation, energy-dense fertilization, and related heavy-engineering modifications of both fresh-water flows and land. Once "artificial" means of this sort have established significant increases in biomass production of vapor, this vapor columning will have a pump-priming effect on the development and positioning of weather systems.

Generally speaking, the efficiency of this process is constrained by the energy flux density of plants individually, and the energy flux density of biomass per hectare. The more energy we add to the soil, as in the form

of fertilizers, and the more efficiently we manage the addition of trace-element additives to enhance biomass per plant, the greater the two desired beneficial effects. These desired effects are increased rates of conversion of solar radiation into biomass, plus strengthening of the vapor production that maintains a major and subsidiary weather systems.

The answer to these needs is not to continue the lunatic doctrine of "wilderness areas." The United States, in particular, needs a major increase in multiple-use forests. These forests must be developed on the basis of modern biological technology—for their efficiency in converting solar energy into useful biomass. They supply wood and recreational facilities, maintain watersheds, and perform a key part in stabilizing our weather. More trees and parks in urban areas should be a significantly promoted national policy.

Globally, as well as nationally, weather control must be situated in a context of qualitative advances in management of fresh-water systems. The leading edge of this effort must be the commitment to develop arid and desertified regions. This must be complemented by a coordinated biomass-development program, with emphasis on high energy-flux-density modes of high-technology food production.

This must be supplemented by biological research and development programs on a much-enlarged scale. We must break out of the reductionists' confines of mere genetics, and focus on the function of ribosomes and of whole biological processes in regulating the activity of the DNA "chemical plants."

*These excerpts are from "It's Time to Change the Weather Modifiers," issued by LaRouche Aug. 1, 1980.*



## Agriculture in Crisis

# Drought, U.S. Economic Policy Menace Farm Sector

**T**he American agricultural industry is now facing one of its worst crises since the 1920s, exacerbated by the 1980 drought, which has caused extensive damage to crops and livestock. The 1980 drought, the most intense since the 1930s Dust Bowl and the 1950s Great Texas Drought, was aggravated by the Carter administration policy of eliminating water resource-development projects and its tight-money economic policy that has forced producers to forego the capital expenditures in land improvement, irrigation, and production methods that would prevent a new Dust Bowl.

But the drought itself is not the crux of the problem in the farm sector. Over the past four years, government economic and farm policy in particular has sent the financial well-being of farm producers from bad to worse, to the point that they are today teetering on the edge of bankruptcy. The 1980 drought will push many producers off this economic cliff, seriously dislocating the nation's food-

producing capacity. It has already dealt the battered livestock industry a serious, perhaps lethal blow.

More broadly, the drought has thrown the entire future of agriculture and industrial growth in the western states into question. The Sun Belt boom in the West has been an island of economic promise in a sea of national economic decline, but now zero-growth propagandists are using the drought to prove that 19th-century Malthusians were right in insisting that the American West was a natural desert that should not be inhabited or developed.

### Bankruptcies Feared

"It's more than just drought you're dealing with," explained David Samuelson, a rancher and county commissioner in Texas who is a spokesman for the American Agriculture Movement. "The real kicker on this thing is the weak financial position of the producers. They're being hit with a drought at a time when they have no financial reserves to deal with it. They're all loaned up, and the bankers are calling in the loans."

1930s photo by Rothstein/USDA



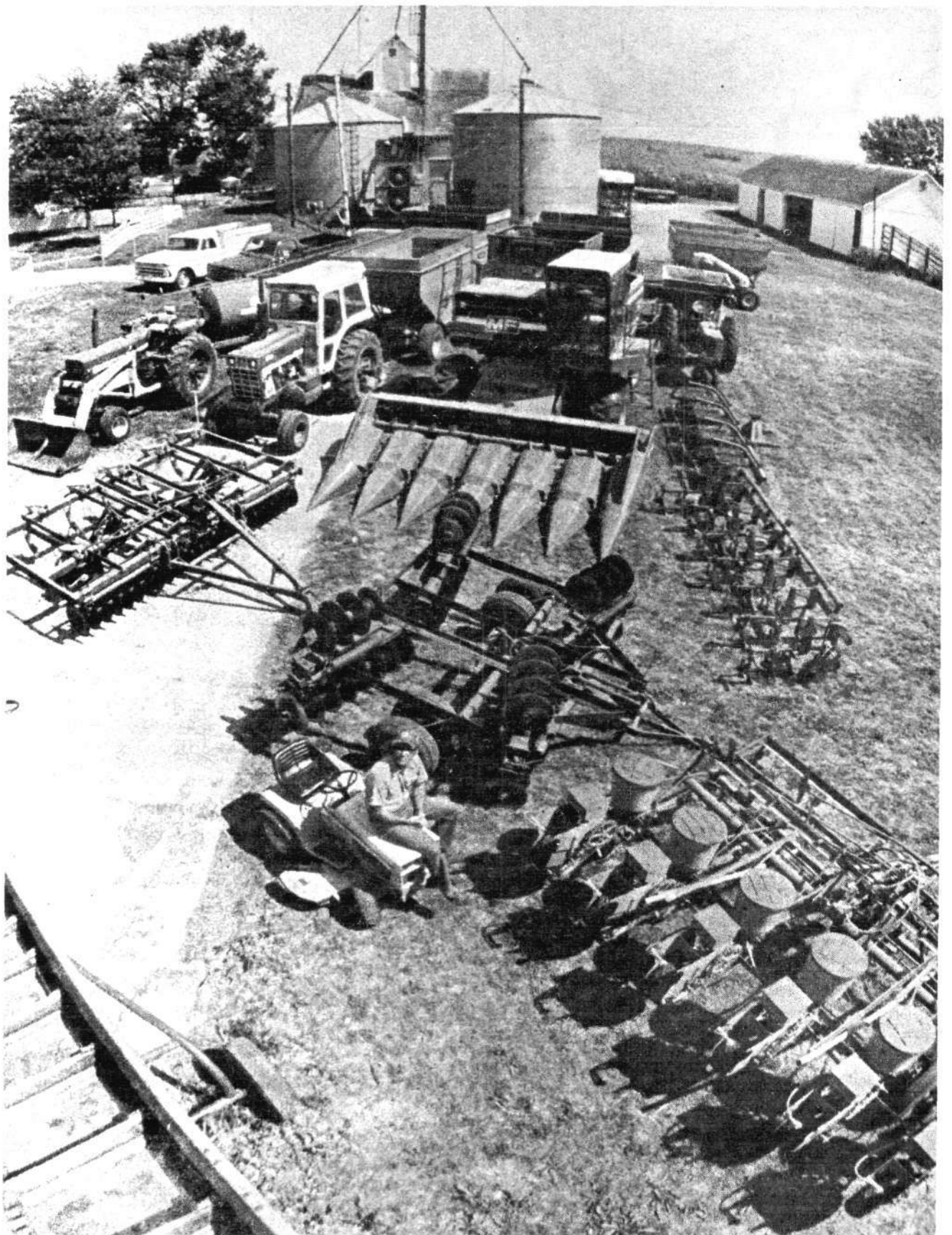

Photo of John Miller in Cedar Falls, Iowa/USDA



What Samuelson and others fear is a flood of bankruptcies if President Carter does not use his authority to declare a moratorium on federal farm-loan repayments and enforce 90 percent parity. Even the optimistic USDA forecasts predict a 25 to 35 percent reduction in 1980 net farm income from 1979—as of the second quarter it was plunging at an annual rate of 40 percent.

In these circumstances, giving a farmer another loan, even a "disaster loan," is like offering a drowning man a drink of water. Producers have been piling up second and third mortgages and loan upon loan for the past two decades, papering over the fact that they were operating at profit levels below cost of production. When the Carter administration's economic policy sent production costs up by more than 50 percent for the key inputs of energy and fertilizer and raised the cost of credit to 20 percent, producers' cash flow was slashed. With little or no equity left and no cash reserves, they have no leeway to credit-manage their way through the season.

Comprehensive evaluations of the drought's damage in terms of livestock and crop losses and inevitable yield reductions are not yet available, but preliminary estimates in various states give an idea of their magnitude:

The heat and drought moved into the Corn Belt just at the critical pollination stage of corn development. In irrigated areas the crops were able to staunch the weather, albeit at tremendous fuel costs to producers to keep the irrigation pumps running.

But in areas of dryland cultivation (that is, nonirrigated areas completely dependent on rainfall), crops were wiped out. Overall yields will be down significantly, anywhere from 10 to 25 percent. The consequent spurt in feedgrain prices will in turn rebound against the livestock sector.

The drought's effects on the cattle industry have been devastating. Pastures have burned up, stock ponds are dry, and the cost of irrigation or supplemental feeding is prohibitive. Nor can most producers afford to ship their herds to "greener pastures" since they have been losing money for seven years and the Carter administration's tight money measures have sabotaged every attempt to rebuild herds.

A massive sell-off of herds has begun, with cow-calf pairs—the breeding stock itself—streaming to market throughout Texas, North Dakota, South Dakota, Montana, New Mexico, and Missouri. One-half of America's cattle herd is at stake.

Crop damage has been estimated at \$1.2 billion in North Dakota, \$1.5 billion in Missouri, \$450 million in Georgia, \$500 million in Arkansas, and \$2 billion in Texas. Arkansas, the nation's chief poultry-producing state, has also lost 8 million broilers and breeder hens.

Texas feedgrains will be down 50 percent this year and

many vegetable producers are going bankrupt. Subsurface moisture is rapidly disappearing while dryland farming has been almost completely destroyed. The real danger is that the strong Texas winds will start to blow the loose, dry soil, creating a new Dust Bowl this fall.

### Water Resource Management

All this could have been prevented by a comprehensive water development program such as NAWAPA (see p. 66). But the Carter administration policy has taken the opposite approach to the problem.

Work on the critical Central Arizona Project, one of the items on President Carter's 1977 water project "hit list," was postponed until the state passed a series of highly restrictive conservationist water-use laws this year. And even the urgently required new water from the project will not satisfy the area's growing needs.

The Carter administration's original argument against the Bureau of Reclamation and Army Corps of Engineers' water resource development projects, because of their size and cost, has more recently been replaced by the argument that it is more appropriate to accommodate to the harsh realities of nature.

The drought has become the springboard for the promotion of dryland farming in the critical Plains area, the heart of the intensive feedgrain-livestock industry, and a reconsideration of the merits of developing the West overall. Roger Sandman, emergency aid coordinator for Agriculture Secretary Bergland, commented on the drought in an interview to the *Christian Science Monitor*: "We've gotten awfully irrigation crazy in the last few years. Water is not an unlimited resource."

Several publications have advertised this trend toward dryland farming recently, advocating this "limited inputs" method in spite of the fact that it significantly reduces productivity. The records show, however, that it is nothing but the economics of austerity that is fueling the interest in dryland farming.

In the Texas High Plains, an Interior Department study projects a 45 percent drop in irrigated acreage by the year 2000—providing that water conservation cuts water use by 20 percent. By the same time, the study says, irrigation in western Kansas will have dried up.

"We'll run out of money before we run out of water," is the way one producer put it. Energy costs have pushed irrigation charges through the roof. In the Oklahoma Panhandle, for instance, natural gas prices have tripled in the past two years. A U.S. Soil Conservation Service official estimates that it costs about \$70,000 to irrigate a half-section, or 320 acres, of land today. Because farm producers' income cannot justify this investment, they will revert to dryland practices rather than replace existing wells. "Instead of 135 bushels per acre, we're probably talking about 85," a Panhandle producer told the *Sunday Oklahoman* recently.

The demoralization being bred in the West was highlighted in the remarks of a Kansas farmer: "Maybe we overdeveloped the area beyond its real potential," he said. "Maybe we can't maintain this standard of living."

—Susan Cohen

*Capital-intensive American agriculture uses more steel than the auto industry. These capital inputs—and productivity—are now threatened by stringent credit conditions.*

# Millions May Die In African Famine

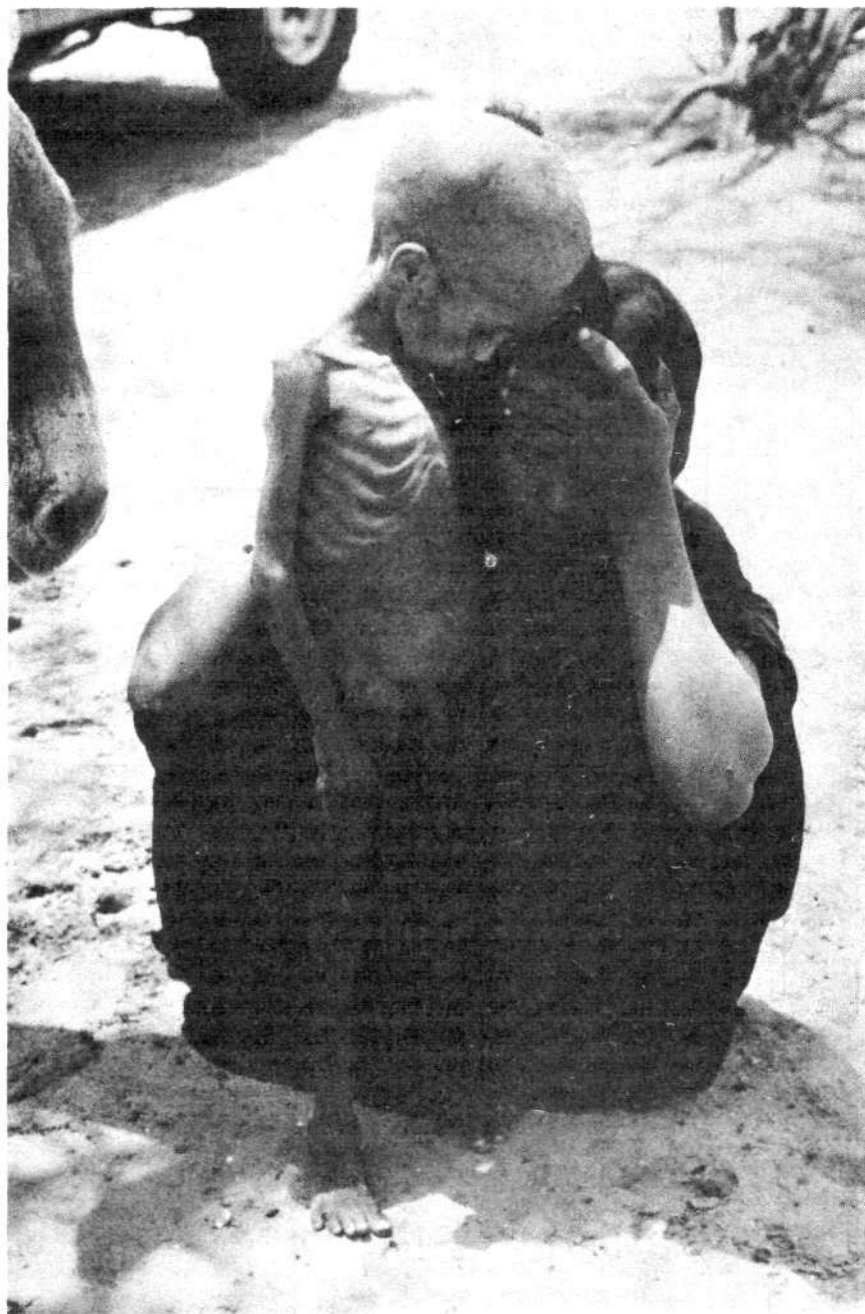

---

*'About 400,000 people are dying of starvation at the rate of 400 to 500 per day. . . . A small portion of U.S. grain reserves would solve the problem.'*

---

**T**en million persons may die in Africa before fall if international relief is not mobilized immediately—people are now dying at the rate of 400 to 500 per day in parts of the continent. In line with the International Monetary Fund, which has responded to the situation by ordering further reductions in African consumption levels, the Carter administration has refused to act. Stored U.S. grain—25 million metric tons of it—still remains in storage.

The immediate cause of famine is a long-standing drought afflicting large sections of Africa. Behind the drought is a collapse of agricultural activity, the result of the "conditionalities" policy of the IMF, which has demanded production and consumption cutbacks as a prerequisite for aid. The IMF financial strangulation of the worst-hit African nations also underlies the other leading reason for starvation, a massive refugee problem caused by regional warfare.

The famine area extends from Senegal on the west coast to Ethiopia and Somalia on the east, southward along the east coast through Kenya, Tanzania, Mozambique, and Zambia. Officials of the U.S. Agency for International Development report that this summer's harvest could range 30 to

*A scene from Mauritania in Africa's Sahelian Zone, ravaged by drought in 1973.*

UN/Bibic



50 percent lower than normal throughout much of eastern Africa, and that aid must come from without.

#### Disastrous Wars

A series of disastrous wars in north-eastern Africa, led by the Somalia-Ethiopian conflict, has aggravated the situation. These include the Eritrean secessionist movement in Ethiopia and the political disintegration of Uganda after Idi Amin's overthrow during a war with Tanzania.

Five million Ethiopians are in desperate need of food. Seven hundred thousand of these are refugees from the war-ravaged regions, primarily Eritrea and Ogaden province. Two and one-half million refugees from these two provinces who have fled into Somalia now barely survive in United Nations camps. In this case the London weekly *Economist* predicted "mass starvation" if 80,000 tons of food do not arrive in Somalia before September.

More than 1 million refugees have also entered Sudan from Uganda, Eritrea, and other Ethiopian provinces.

The area of greatest immediate concern is the Karamoja district of northern Uganda, where about 400,000 people are dying of starvation at the rate of 400 to 500 per day. They require an estimated 4,000 tons of food a month; at latest report, only 1,600 tons a month are being delivered.

In eight east African nations—Djibouti, Ethiopia, Kenya, Uganda, Mozambique, Somalia, Tanzania, and Zambia—9.2 million persons are "refugees and drought-affected nomads." Meanwhile, 15 other nations are experiencing food-supply reductions: Senegal, Mali, Mauritania, Rwanda, Chad, Swaziland, Angola, Malawi, Zimbabwe, Namibia, Lesotho, Botswana, Sudan, and Zaire.

In Zaire, large sections of the population are subsisting at intake levels of 1,000 calories a day—the levels of Nazi concentration camp victims. Yet, the IMF has demanded reduced food production and consumption levels in Zaire as a condition for further financial aid.

#### 1.6 Million Tons of Grain

A small portion of U.S. grain reserves would solve the problem. According to experts, only 1.6 million

metric tons of grain during the next 12 months would maintain minimum diet requirements in the "at risk" nations. Three million metric tons of grain would raise these populations above the "minimum required."

The United States has scheduled aid through several official and private agencies, but most of it is not to arrive until next spring; and by that time, millions of Africans will be dead. Their lives could be saved—if the president

were to immediately order purchase of 3 millions tons of grain at parity prices from U.S. farmers for immediate shipment, together with vehicles and personnel required for an effective distribution program. Were the president to follow such aid with a commitment to develop capital-intensive agricultural production in Africa, "desertification" in Africa could be reversed.

—Vin Berg

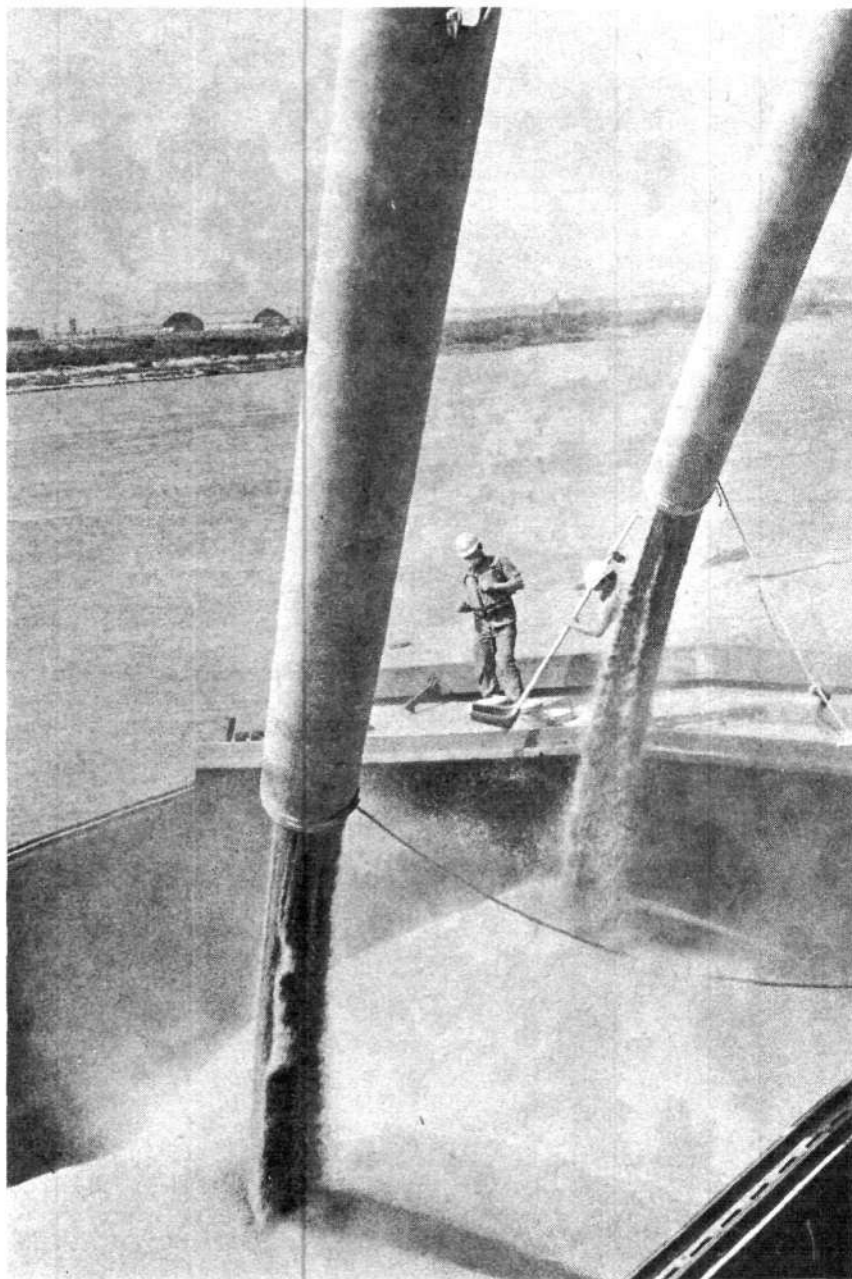

Photo by Murray Lemmon/USDA

Just 1.6 million metric tons of the 25 million ton U.S. grain surplus could stave off starvation in the "at risk" African nations. Here grain is loaded onto barges in Kansas City.

# We Need A National Water Plan Now

The great droughts of 1976 and 1980 have confirmed what many agricultural and industrial planners have been saying for years: To increase agricultural capacity (instead of losing it), the United States has to augment the continental water supplies of North America with a grid-like network of canals and reservoirs integrated both in the north-south and east-west directions.

The basis of exactly such a comprehensive plan—the North American Water and Power Alliance (NAWAPA)—has been politically shelved in the United States and Canada for more than 15 years. Meanwhile, the Soviet Union, after carefully studying NAWAPA, has committed the resources and technology for tilting the flow of major Siberian rivers toward the agricultural heartland of the Ukraine—an American-style policy based on intensive infrastructural development.

Even more devastating to U.S. agriculture than the drought is the long-term Carter administration policy of eliminating large-scale water projects and replacing them with conservation measures and maintenance of national river systems. This summer, for example, the administration advocated a water policy favoring "wild rivers" in the West and continued to oppose funding for six surviving federal water projects; twelve have already been terminated.

The Central Arizona water project was modified to eliminate three dams and then was made contingent upon state passage of strict water-conservation laws, passed this June.

To take another example of the conservation approach, California has decided to build the Peripheral Canal circumventing the San Francisco Bay, which will waste fresh water needed for industry and agriculture in central and southern California, in order to preserve estuary ecosystems. Ironically, both man and the marine environment would be better served using the seawater barrier method initially planned under NAWAPA. Modeled on Holland's great Zuider Zee land reclamation project, this system controls saline saltwater intrusion in periods of low river flow or drought and controls flooding in periods of high river flow.

In the wake of December 1979 regulations promulgated by the president's Water Resources Council, which generate fierce regional and local competition for scarce water supplies and make it difficult to identify a water

development project as in the national interest and worthy of federal support, states from Montana to Texas are involved in a federally funded study for lifting water thousands of feet to redistribute the increasing poverty of present regional water supplies.

In addition, the proposed government-subsidized syn-fuels programs in the Rocky Mountain states will impose tremendous demands on water supplies.

## A Comprehensive Solution

On the contrary, all the problems of agricultural irrigation, industrial water use, and environmental degradation emphasized by the 1980 drought can be solved by a comprehensive water development project such as NAWAPA (see map). The natural river systems of North America can be exploited to expand water supply vastly, in conjunction with a large-scale engineering effort to capture the millions of acre-feet of water now lost through runoff and redirect it for multipurpose use.

The NAWAPA project was first proposed in 1964 by the Ralph M. Parsons Engineering Company and further elaborated by the Fusion Energy Foundation (*Fusion*, Dec. 1979, p. 53). Had the project been launched on schedule in the mid-1960s, the 1980 drought would be an easily manageable problem.

Starting in southern Alaska and extending into western Montana, surplus runoff water would be collected from the Rocky Mountains and delivered for use in southern California, Arizona, Texas, and Mexico. It would also be directed eastward through channels leading to the Great Lakes and Mississippi River. Using appropriate nuclear-explosive construction methods, the project would cost about \$130 billion and take 10 to 15 years to complete.

Returns on this NAWAPA investment would include a near-doubling of irrigated fertile acreage in the states west of the Mississippi; a near-doubling of hydroelectric power

*The canal system in California's productive Imperial Valley is the largest in the Western Hemisphere, with 3,163 miles of canals.*



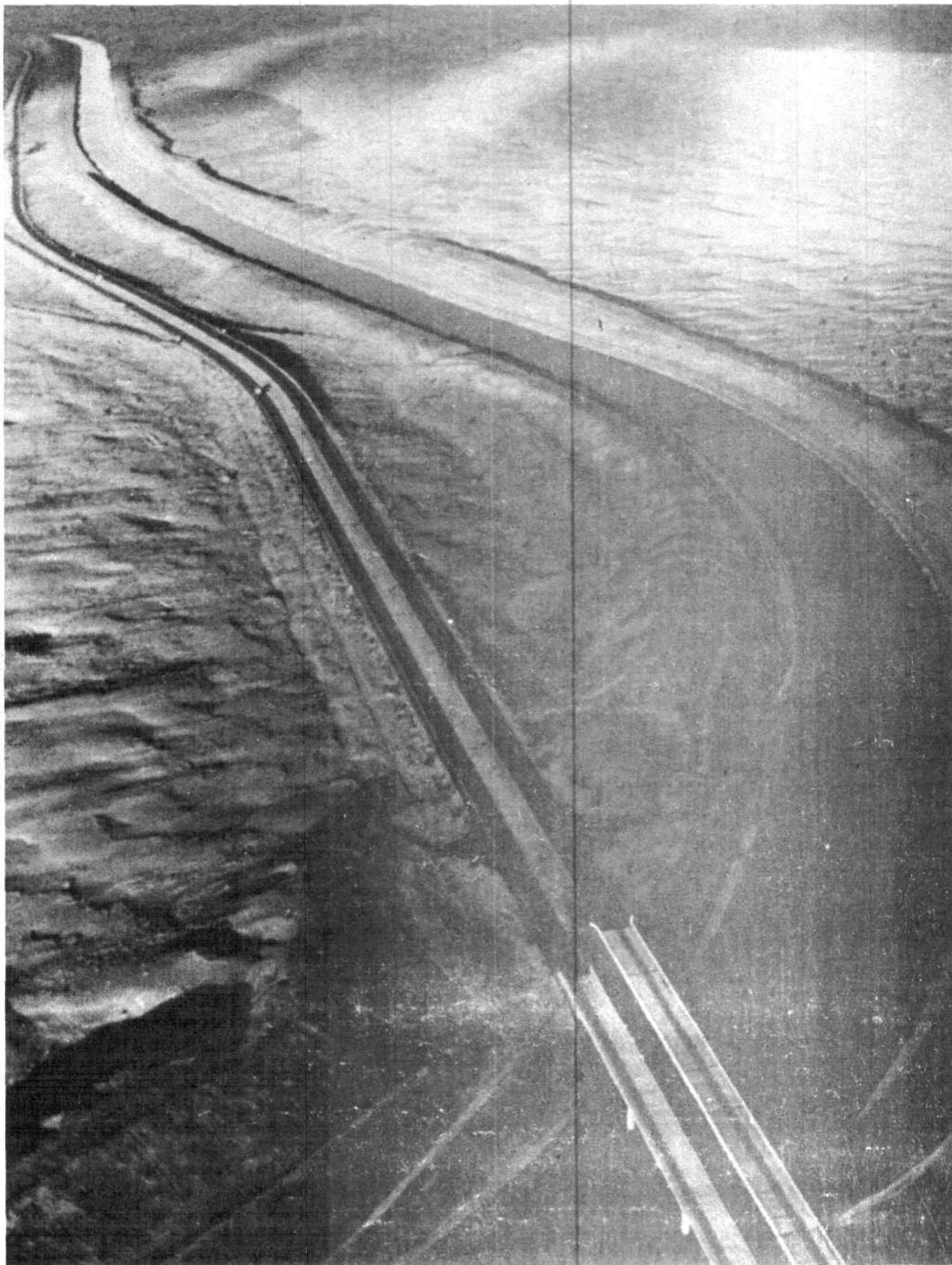
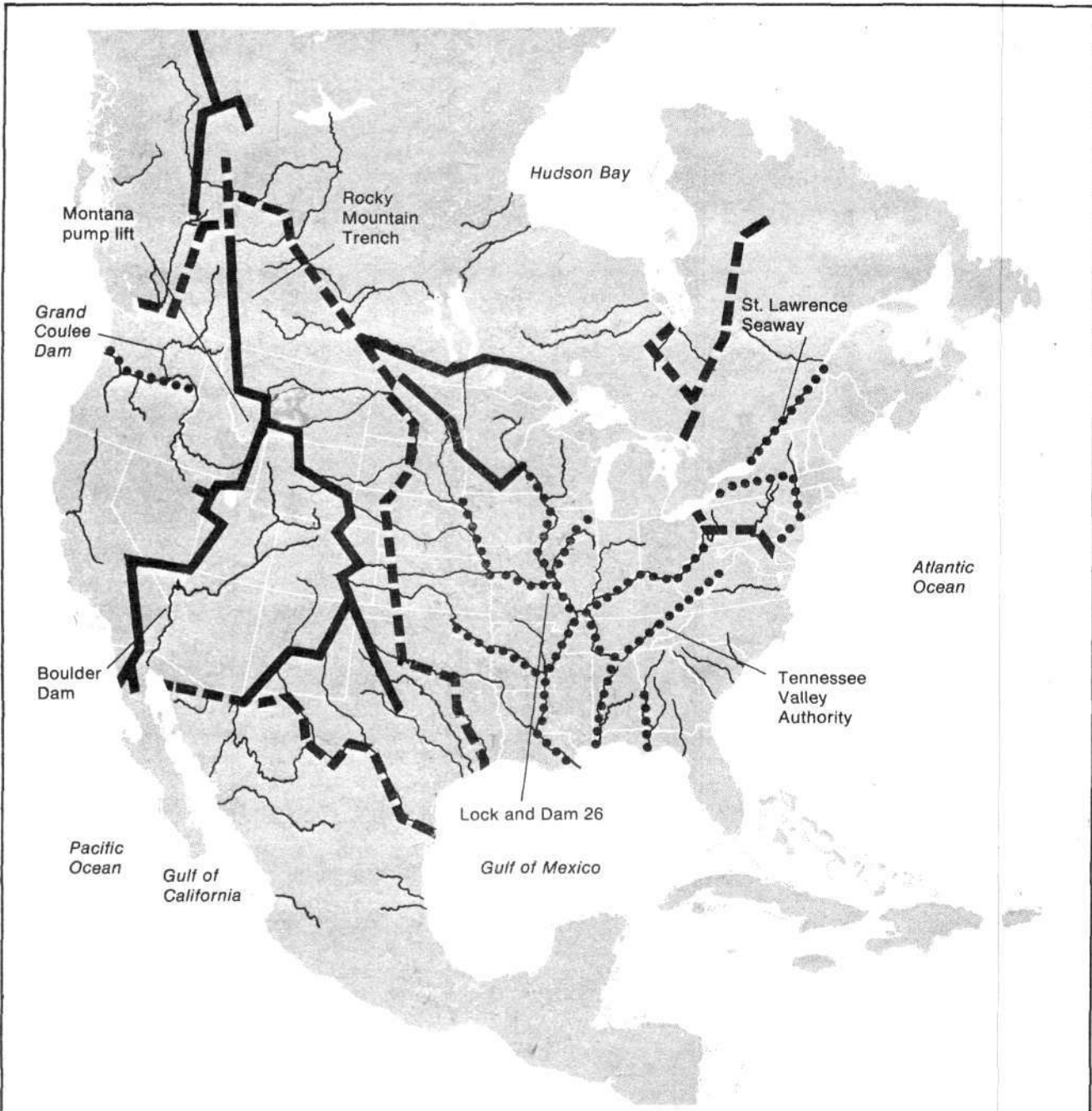

Photo by Charles O'Rear/USDA



- Key**
- ..... Existing navigable waterways
  - New canals linking existing waterways for expanded water delivery and navigation
  - Canal systems to be upgraded for expanded water delivery
  - ~~~~~ Natural river systems

**NORTH AMERICAN WATER AND POWER ALLIANCE PLAN**

*The NAWAPA masterplan for continental water resources, using natural river systems of North America together with a large-scale system of canals and dams*



## STABILIZING AND GROWTH-INDUCING IMPACT OF NAWAPA ON THE WEST

Water Resources Council region	Average annual runoff	Average annual NAWAPA delivery (million acre-feet/year)	Total
Canadian Plains Provinces	—	30	—
Pacific Northwest	298	14	312
California	81	15	96
Great Basin	15	12	27
Colorado River Basin	18	15	33
Rio Grande	5	9	14
Texas-Gulf	37	8	45
Arkansas River Basin	72	12	84
Missouri Basin	64	30	94
Great Lakes	150	50	200
Lower Mississippi	660	15	675
Northern Mexico	28	40	68

*Comparison of the present average annual flows of major western river-basin systems with the projected annual delivery of the NAWAPA continental plan.*

production in the United States alone; a vast expansion of the continental inland waterway system; and a significant augmentation of water flow into the existing continental river system, alleviating transportation bottlenecks in what are now periods of low natural flow. The project would also produce a significant net increase in ground water reserves in areas like the Southwest and Texas High Plains, which were hard hit by drought this year.

The impact of the NAWAPA plan on stabilizing water supply and inducing growth is demonstrated in the table, which compares the present average annual flows of major western river-basin systems with the projected average annual delivery of the NAWAPA continental plan. The intersection of the grid canals with the natural river systems in the West, at elevations commanding the major economically productive areas of these basins, provides the impetus for a major increase in production. The increased water consistently available sustains present and future productive investments, with the key hydrographic areas receiving augmented water supplies 20 to 180 percent of their present annual averages.

### American History of Development

Water-system development has historically progressed from lower to higher-ordered forms of integrated benefits. During the early years of the republic, most designs were based on the concept of controlling river water according to the amount of water flowing at any moment, called "run of the river." When flow dropped below that needed for navigation or powering mills and factories, economic activity diminished.

In the East, this was generally acceptable since rivers

there are augmented by groundwater inflow (influent rivers). But in the West, where seasonal and annual flow volumes are so low that water flows from the river to the groundwater (effluent rivers), the new concept of "carry-over storage" was required. Carry-over storage uses dams with storage capacity in excess of projected annual needs of urban or agricultural users in order to carry over surplus water from years of above-average flow to years of below-average flow.

The next step in water development evolved during the fight for a high, multipurpose dam on the Colorado River. In the early 1920s Congressman Phil Swing of California's Imperial Valley district initiated a bill for a dam combining the benefits of irrigation, hydroelectric power, and flood control. Before the dam was authorized by Coolidge in 1928, Swing deflected various direct bribes and dirty tricks by political opponents and fought a trumped-up charge of unethical conduct in a courageous debate on the floor of Congress.

Swing brought the fight to the American people by distributing a fact sheet on the benefits of the program coast to coast and was successful in his fight for the Boulder Dam, which today represents both the political and technological basis on which subsequent water projects have been modeled.

Now is the time to implement NAWAPA, in the tradition of the nation's mastery of nature for human purposes. A sound water resource development policy will encourage the extension of highly capital-intensive agriculture and the acceleration of technological innovations. NAWAPA will play a key role in feeding a growing world.

—Calvin Larson



**Solving the Problem**

**Bringing U.S. Productivity  
To Mexico: *A Firsthand Report***

by Cecilia Soto-Estévez



**T**he Fusion Energy Foundation and its Mexican co-thinker, the Mexican Association for Fusion Energy (Asociación Mexicana de Energía de Fusión—AMEF), jointly sponsored a research project to apply the La-Rouche-Riemann econometric model to develop an economic program for Mexico last spring. They quickly discovered that the first focus for such a program must be developing Mexico's agriculture, in order to provide an adequate diet for Mexico's population as well as to free the millions of stoop laborers to become the industrial workers of Mexico's economy. Cecilia Soto-Estévez, executive director of AMEF, reports here on the enthusiastic reception of the FEF-AMEF agricultural program by Mexican farmers and describes the problems in developing Mexico's tremendous agricultural potential.

\* \* \*

MEXICAN AGRICULTURE could match the productivity of present U.S. agriculture by the year 2000 and surpass it by the year 2020 if the FEF-AMEF "selected area" program for development is adopted. But if present methods prevail, the only future for Mexican agriculture is total collapse.

It is not only that there has been a persistent pattern of stagnation in this sector since 1966. Worse, a dramatic collapse in the levels of basic grain production over the past five years has resulted in a drastic lowering of the caloric consumption per capita for a wide section of the population. In some poverty-stricken rural areas caloric consumption has fallen from the former inadequate level of 1,900 calories per day to the present bare-survival level of 1,600. The two-year drought has now forced the Mexican government to increase food imports 100 percent, threatening the entire Mexican economic strategy of using oil revenues to guarantee an accelerated industrialization process.

The FEF-AMEF program to solve this problem centers on designing a major hydraulic system for irrigation and analyzing Mexican agriculture in terms of energy throughput. The hydraulic system, a 40-year program with three stages of developing major hydraulic projects, is summarized in the box on page 72. It will solve a major problem of Mexican agriculture: There is plenty of water where land is inadequate and plenty of fertile soil where water is inadequate.

### Energy Throughput

The FEF-AMEF agricultural research team, working under the direction of FEF research director Uwe Parpart, analyzed the three types of agriculture that coexist in Mexico, comparing the energy throughput of each. First, there is the modern agricultural sector, with capital-intensive methods and irrigated land. Second, there is the relatively efficient rainfed sector. Third, there is the subsistence agricultural sector of Indians and very backward peasants. The results of this comparison were encouraging for those committed to a prosperous future for Mexico

but devastating to those native environmentalists who call for preserving "traditional agriculture."

The study showed conclusively that "traditional agriculture," that is, subsistence agriculture, represents the most monstrous waste of energy, literally consuming the flesh and blood of 13 million peasants to produce merely a 1,600 calorie per day diet for only six months of the year. The low energy throughput of this agricultural mode results in less efficient energy use, consuming more energy per ton of produce than the other two systems. (See Figure 3 on page 33.)

On the other hand, the study showed that virtually every increase in energy throughput for the two relatively advanced agricultural sectors by means of irrigation, agrochemical products, fertilizers, or mechanization resulted in a nonlinear increase in the energy-use efficiency, thus yielding more agricultural product for less input energy.

Given these facts, we designed the most efficient method for improving the present irrigated land up to U.S. levels of productivity, drastically improving water distribution in rainfed farms, and bringing new land under irrigation. The key role is to be played by "selected areas," that is, small areas where the most advanced agricultural methods would be applied. This concentrated effort is the most efficient method for rapidly increasing agricultural output. The dramatic increase in crop yields in these areas would then convince peasants and small farmers of the benefits of using modern technology.

Instead of spreading a few agricultural techniques throughout a peasant population that would tend to resist their application, the "selected area" method would overcome this resistance to modern methods by demonstrating their success. Although there is practically no farmer who would not gladly exchange his draft animal for a tractor, there is resistance to the use of genetically improved seeds, agrochemicals, and so on, especially among farmers in the less-developed southern part of Mexico. This is why the willing cooperation of the farmer to apply modern agricultural techniques must be secured by successful "selected areas."

The selected areas concept has already proved effective in the case of Jalisco. Jalisco, the most efficient corn-producing area of the country, became so by using Iowa's corn-producing methods as its model. In a period of five years, Jalisco increased its productivity 100 percent each year, up to 4.5 tons per hectare. By comparison, in 1978 the average yield for all irrigated land was 3.8 tons per hectare, for efficient rainfed land 2.0 tons per hectare, and for subsistence land merely 0.8 ton.

The powerful incentive of success is also the most useful way to overcome the complications in the political situation arising from incomplete and controversial agrarian reform. The AMEF plan will expand the selected areas systematically, the pace being set by the ability of the peasantry and farmers to assimilate modern technologies and by the progress of the modern hydraulic systems being built as part of the program. If this program is implemented, by the year 2000 Mexico's countryside will

be one huge "selected area" with productivities as high as U.S. levels. By the year 2020, even present U.S. productivity levels could be surpassed, freeing millions of workers to take part in the industrialization of Mexico.

### The AMEF Tour

Once the agriculture component of the FEF-AMEF economic program for Mexico was completed, the AMEF sponsored a series of conferences and forums in Mexico

to present the program and catalyze the already heated debate on the government's agricultural policy. Patricio Estévez, leading spokesman for the AMEF, toured Mexico to present the AMEF ideas to agriculture-related audiences and to counter the environmentalist attacks on the government's Mexican Food System (known by the acronym SAM) with the AMEF program.

The key issue in the debate around SAM is mechanization. Although the government has officially set forth as

## FEF-AMEF PROGRAM TO INCREASE MEXICO'S WATER SUPPLY AND DISTRIBUTION

Development parameter	Year of development					
	1980	1985	1990	2000	2010	2020
<b>Cropland</b> (in million hectares)						
Fully irrigated arid land	5.4	6.0	7.0	10.0	15.0	19.0
Supplementally irrigated	—	1.0	1.5	5.0	7.0	9.5
Good rainfed	8.0	8.0	8.0	6.5	6.5	6.5
Poor rainfed	6.0	4.4	2.9	0.5	—	—
<b>Total</b>	<b>19.4</b>	<b>19.4</b>	<b>19.4</b>	<b>22.0</b>	<b>28.5</b>	<b>35.0</b>
<b>Water supply</b> (in billion cubic meters per year)						
Surface sources	46.5	100.0	122.0	195.0	265.0	290.0
Groundwater	18.5	20.0	23.0	40.0	65.0	125.0
<b>Total</b>	<b>65.0</b>	<b>120.0</b>	<b>145.0</b>	<b>235.0</b>	<b>330.0</b>	<b>415.0</b>
<b>Water use</b> (in billion cubic meters per year)						
Full irrigation, arid land	50.0	80.0	93.0	133.0	200.0	253.0
Supplemental irrigation	—	6.5	10.0	34.0	47.0	64.0
Domestic and industrial	7.2	18.5	30.0	40.0	43.0	50.0
<b>Total</b>	<b>57.2</b>	<b>105.0</b>	<b>133.0</b>	<b>207.0</b>	<b>290.0</b>	<b>367.0</b>
<b>Major crop production</b> (in million metric tons)						
Food grains	3.5	5.7	8.0	18.0	25.0	33.0
Feed grains	16.5	36.5	61.5	115.0	170.0	230.0
Soybeans	—	1.3	2.5	12.0	28.0	40.0
<b>Total</b>	<b>20.0</b>	<b>43.5</b>	<b>72.0</b>	<b>145.0</b>	<b>223.0</b>	<b>303.0</b>
<b>Population</b> (in millions)	<b>67.0</b>	<b>81.0</b>	<b>92.0</b>	<b>115.0</b>	<b>135.0</b>	<b>156.0</b>
<b>Animal protein</b> (in million metric tons)						
Required	1.7	2.1	2.4	2.9	3.4	4.0
Produced	0.6	1.2	2.4	5.1	8.9	13.5
<b>Fixed investment</b> (in billion U.S. dollars)						
Farm machinery	1.5	18.0	45.0	60.0	80.0	105.0
Dams, canals, land improvement	1.5	10.0	27.0	80.0	110.0	140.0
<b>Total</b>	<b>3.0</b>	<b>28.0</b>	<b>72.0</b>	<b>140.0</b>	<b>190.0</b>	<b>245.0</b>
<b>Pumping power for all water</b> (in billion electric watts)	<b>1.0</b>	<b>7.0</b>	<b>16.0</b>	<b>40.0</b>	<b>75.0</b>	<b>95.0</b>



one of its main goals the modernization of the countryside and President López Portillo himself has repeatedly praised U.S. agriculture as the model to follow, most official agricultural planners have fallen for the fallacious argument that "a too rapid modernization of agriculture will throw too many peasants out of work." Thus the government's emergency program SAM has found itself in the midst of a battle. On the one side the environmentalists and Maoists attack it for not being an "authentic

program for indigenous agriculture" (stoop labor); on the other, the AMEF is organizing support for much more ambitious agricultural proposals.

To take one example from the Estévez tour: The SAM recognizes that some modern technology must be introduced to make a dramatic rise in food production, and proposes widely distributing generous amounts of fertilizers and improved seeds, especially among peasants of the subsistence sector, but with little mention of mecha-

## The FEF-AMEF Water Plan for Mexico

The hydraulic plan for Mexico developed by the FEF and AMEF will increase irrigated land in Mexico by a factor of 5, nearly doubling the total cropland (see table). Using the Mexican government's 1976 National Hydraulic Plan as a starting point, the FEF-AMEF plan adds two major modifications to link the water supplies of the continent into a single unified grid.

This grid is established by transferring water from the southern coastal areas of Mexico, where 80 percent of the nation's surface runoff is concentrated, to the northern coastal areas of the country, which have extremely dry but potentially fertile soils (see map). The connecting link in the grid is created by delivering water from Alaska and Canada through the United States by the proposed Rocky Mountain Canal of the North American Water and Power Alliance (see p. 68).

By the year 2020 the coastal canals of the southern link will deliver about 240 billion cubic meters to the lower

elevations along each coast, and the Rocky Mountain Canal will deliver about 50 billion cubic meters to an elevation of 1,500 meters at the continental divide near southwestern New Mexico. These water supplies will be distributed by canals and natural river systems using gravity flow from the north and pump-lift methods from the coastal canals to successively higher elevations in productive inland areas by constructing a water staircase of dams in series. The plan proposes the rapid construction of these canals using peaceful nuclear-explosive construction methods.

These elevated waterways will provide major networks of navigable streams by which inland agricultural and industrial development will transport the bulk commodities of production inputs and outputs.

A new seaway will be built between the Atlantic and Pacific Oceans near Coatzacoalcos, which will significantly shorten major transport routes. A new water-delivery canal on the U.S.-Mexican border will be designed for barge navigation to unlock the tremendous agricultural and mining potential of the southwest.

### Groundwater Supplies

An important adjunct of the water plan is the development of groundwater supplies by artificial recharge methods, using nuclear-explosive fracturing methods to increase direct percolation from riverbeds and hydraulically efficient, high-yielding radial wells that will function both as recharge and extraction systems to balance the seasonal differences in supply and demand.

The plan will lay the basis for establishing Mexico as a leading agricultural nation within 10 years, primarily

by focusing first on the intensive development of existing cropland. This will be accomplished by rapid investments in farm machinery, fertilizers, and U.S.-tested hybrid seeds and farming methods, including rapid growth in the number of large machines used per hectare. Poor land in rainfed areas will be converted to pasture and replaced with full or supplemental irrigation on potentially more productive lands. Systematic development of on-farm irrigation, erosion control, and drainage systems will be accomplished concurrently with increased intensification on existing as well as newly developed cropland.

After 1990 the increase in yields per hectare using U.S. intensive methods will produce a surplus of feed grains, which can be used to produce animal protein in excess of that required by the Mexican population. Again, this requires that current U.S. capital- and energy-intensive methods of poultry, pork, and dairy production be implemented as an immediate priority, while new beef herds are built concurrently, using U.S.-tested breeds. These animals, in modern confinement environments, produce more protein per unit of energy expended than animals raised in more extensive systems of pasture and rangeland.

By the year 2000 Mexico can begin to concentrate heavily on the production of beef for export. The location of crop and livestock areas in the north will gradually shift inland as the canal delivery systems develop, supplanting the relatively isolated south-central Valley of Mexico and pockets of intensively irrigated northern areas with contiguous development radiating from centers of newly established urban support industries.

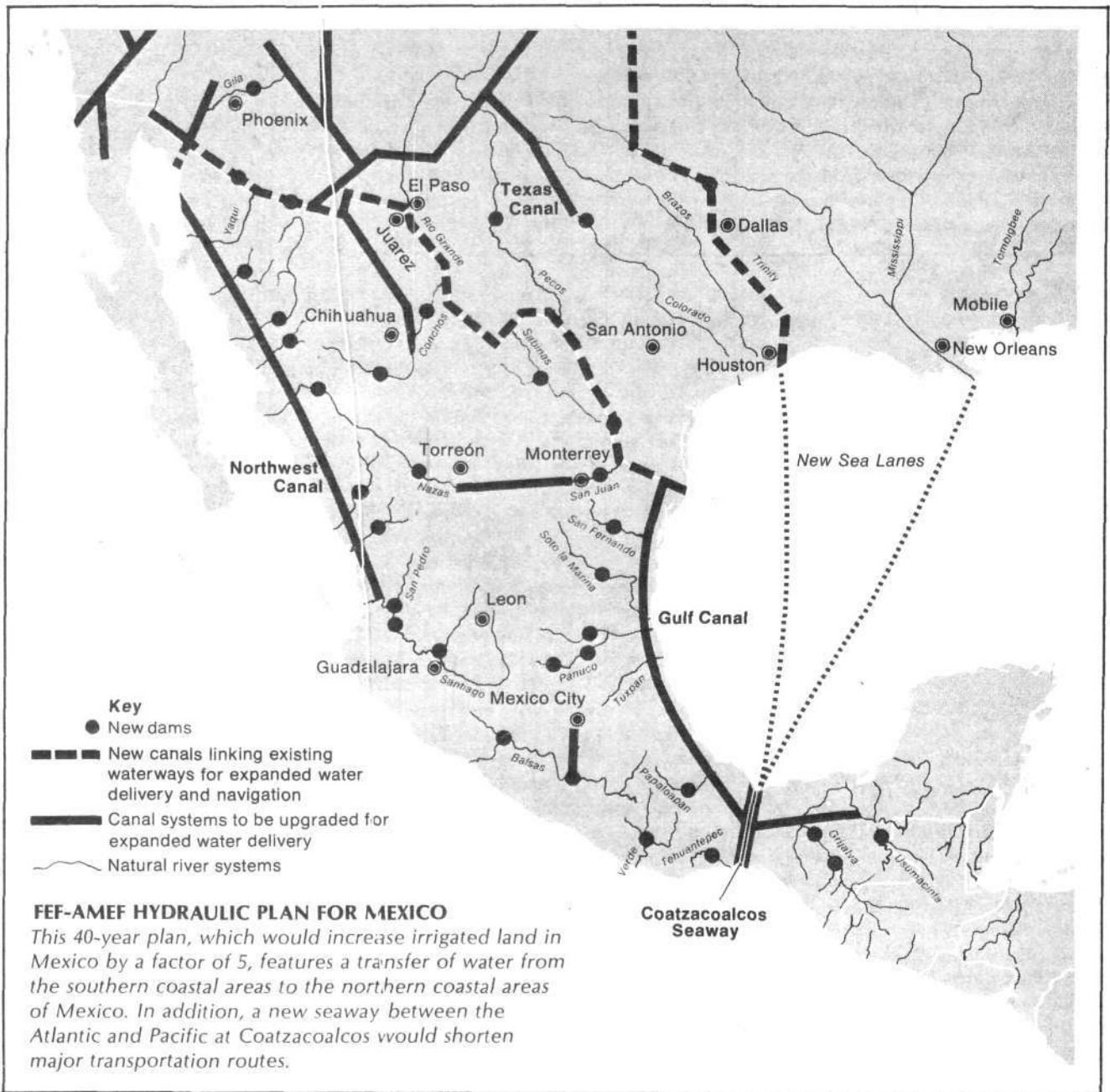

nization. Estévez received a standing ovation when he explained to 300 peasants in the northern state of Sonora that this across-the-board distribution of fertilizers and improved seeds (instead of the selected areas concept) was like a general staff that loses the war by conceding to every little officer's demand to have his own tank.

Estévez's highly successful tour also took him to several universities, including that of Guadalajara, the home base of the technicians who conceived the Jalisco Plan several years ago, using Iowa's corn-producing methods as its model. Approximately 150 students and professors attended the Guadalajara conference, where Estévez showed slides of the hydraulic master plan and the energy-throughput study. The excitement that was generated kept

the questions and discussion going for more than three hours. A study group was then formed to apply the energy-density method presented to a microeconomy study of the Jalisco corn-production model, which tripled the national average of 1.2 tons per hectare.

In addition, students and professors at Guadalajara and at the University of Monterrey undertook a study of the AMEF plan's demands on industry, internationally as well as nationally, particularly the great number of tractors required from the outset.

As for the peasants, they were the most enthusiastic of all. For example, Estévez addressed the Pro-Plhino Coalition in southern Sonora during his tour. The Plhino is one of the canals proposed to bring water from the south to



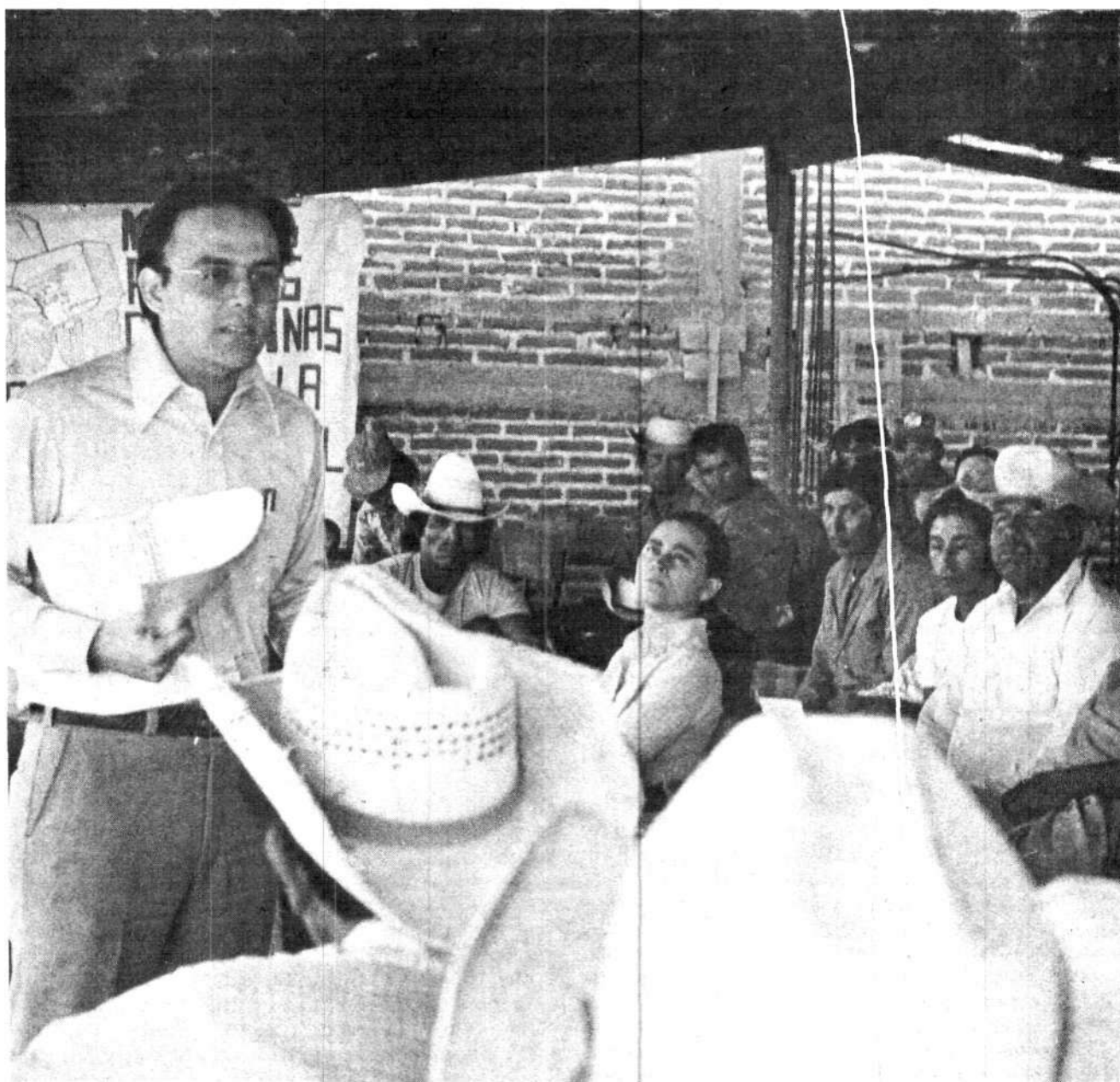

*The AMEF's Patricio Estévez (left) meeting with a group of peasants in Sonora.*

the northwest, a part of the AMEF water plan that was contemplated by the government several years ago but tabled. The canal is essential to keep up and expand the productivity in the northwest. The northern state of Sonora, for example, is the most efficient agricultural production region in the country but faces a growing problem of water shortage. As a result of the drought, this record wheat-producing region, armed with the most advanced methods of cultivation, including central pivot irrigation and laser leveling of land, has now been selected by the government to replace wheat with cactus. Sonora farmers are also supposed to start planting jojoba, an oil-rich seed that has become a favorite with the appropriate-technology faction because it requires extreme labor intensity.

The Pro-Plhino Coalition recognizes that the building of the Plhino canal can prevent this destruction of their wheat-producing capacity and open new fertile areas for crops. They presented Estévez with a document to be shown to President López Portillo in which farmers and peasants volunteer to work on the building of the canal "in case oil revenues are not enough to get it done by other means."

The Estévez tour left no doubt that Mexican farmers want the benefits of modern agricultural techniques. When Estévez reported to one group on how the environmentalist professors are saying, "Peasants don't like tractors," one farmer stood up and exclaimed, "Who said we don't like tractors?"

# Parity

## The Key to U.S. Agricultural Economics

by Lyndon H. LaRouche, Jr.

*Lyndon LaRouche is the originator of the LaRouche-Riemann economic model, based on the applications to the economy of Bernhard Riemann's theoretical work on shock waves. A more detailed description of the model can be found in Fusion (July 1980, p. 57).*

LaRouche, a darkhorse contender for the 1980 Democratic Presidential nomination, led a successful fight at the Texas State Democratic Convention in Houston June 20-22 for a resolution calling upon President Carter to use his existing executive powers to assure farmers 90 percent parity prices for their goods. Parity for farmers is defined as a price not only ensuring the producers a "fair return" on investment, but enough additional income to permit expansion and technological improvement in farming methods.

\* \* \*

Many Americans have been subjected to the myth that falsely asserts that cheap labor means lower unit costs of production. I explode that myth here for the case of agricultural production.

Once we recognize that the net-profit component of true parity values for agricultural products is the margin of investment on which technological

improvements in unit cost of production depend, we begin to comprehend the fact that such net profits are not an amount in excess of the "true cost" of production.

If we are to maintain an adequate supply of food at stable prices, not only must the total investment in agricultural production increase; the average capital investment per acre must also be increased. It is investment in agricultural improvements per acre, including land improvements, equipment, and ratio of energy consumption per acre by agricultural production, that is key to reductions in the unit costs in agricultural output.

Since improvement of marginal land is more costly than maintenance of prime land, the tendency is for agricultural costs and prices to rise, unless costs are kept down by increased efficiencies of the sort that can be realized only through capital-intensive, energy-consuming forms of technological improvements. Therefore, a certain rate of net profit on agricultural products is required simply to maintain the volumes and productivity of production.

If, then, we examine what appears to be cheap food production in other nations from this same standpoint, we immediately note the following fact. What rate of net profit do those coun-

tries require to bring their productivities up to U.S. standards over periods ranging from 10 to 50 years? This calculation proves that the required amount of unit net profit for food production in those countries brings the true cost of that food production up to approximately U.S. parity values!

### The ABCs of Productivity

The basic, first measure of productivity is the average number of hours of productive labor required to produce a fixed quantity of tangible output of goods of competitive quality.

If nations and firms of differing productivities for production of the same products are compared statistically, it is proved that productivity increases in direct proportion to the amount of true depreciation of invested productive capital per average working year of productive labor—exactly as Treasury Secretary Alexander Hamilton proved in his 1791 Report to the Congress *On the Subject of Manufactures*.

This does not mean that we can use the figures for depreciation reported by currently prevailing standard tax-accounting practice. Current tax-accounting practice grossly understates the true current replacement cost of productive capital being depreciated. We must use the price of the quality of capital goods that are the competitive, improved substitute for the cap-



ital goods being used up. The total depreciation (or amortization or depletion) allowed must total an amount adequate to buy the up-to-date substitute for the kind of machine tool or other productive capital being used up.

If we use the misleading, undervalued estimates of depreciation, amortization, and depletion allowed by present, misguided tax-accounting practices, we do show that productivity correlates with levels of depreciation. However, those understated values for depreciation mean giving wrong direction to both investors' and governments' policymaking in connection with both capital-replacement policies and tax policies. If we use correct figures for rates of depreciation, the proof that productivity correlates with depreciation not only proves the fact of the matter, but guides us to proper investment and tax-incentive policies.

Depreciation corresponds to the level of investment in what Alexander Hamilton termed "artificial labor." "Artificial labor" means those machines and other devices that supplement human muscle power with the useful application of the energy produced by hydroelectric, steam, and other production of power for industry and farms. The greater the ratio of such energy in the form of "artificial labor" to human muscle power, the greater the productivity of labor, and the better the possible quality of the product being produced.

Thus, as computer analysis proves conclusively, the levels of true depreciation of an economy, a sector of industry, and particular enterprises correlate with increases in the amount of energy used for production per productive worker employed.

#### Energy Flux Density

It is not sufficient merely to have more energy used per productive worker. The energy used must be produced for use in production at the equivalent of an increase in temperature of the energy-producing process. The proper term to cover all cases is *energy flux density*, the term that covers such units of measure of energy intensity as temperature and voltage.



USDA



*As Enacted by the Senate and House of Representatives of the United States of America in Congress assembled.*  
*That there is hereby established at the seal of government of the United States a Department of Agriculture, the general design and duties of which shall be to acquire and to diffuse among the people of the United States useful information on subjects connected with agriculture in the most general and comprehensive sense of that word, and to procure, propagate, and distribute among the people new and valuable seeds and plants.*

The Agriculture Department, established by President Abraham Lincoln on May 15, 1862, has traditionally promoted high-technology agriculture as "the foundation of manufacture and commerce." Above, top: A team of 33 horses cutting, threshing, and sacking wheat in Walla Walla, Wash., 1902. Below: A 41-ton tractor with wood-covered drive wheels, built in 1900 by the Best Manufacturing Co.

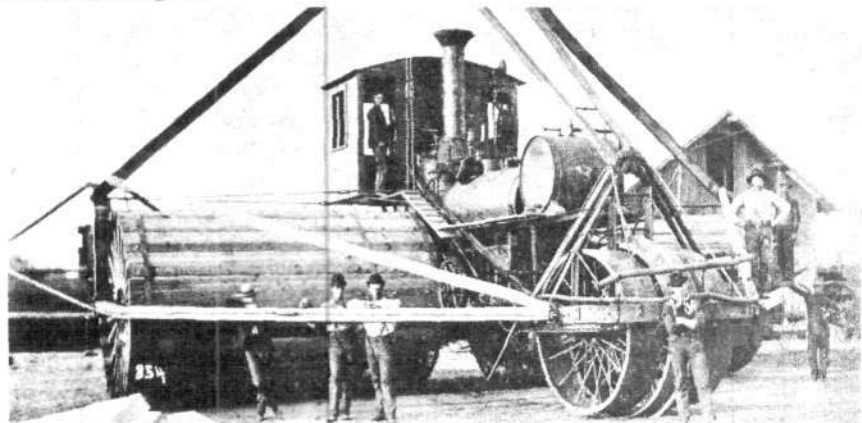

Courtesy Caterpillar Tractor Co.

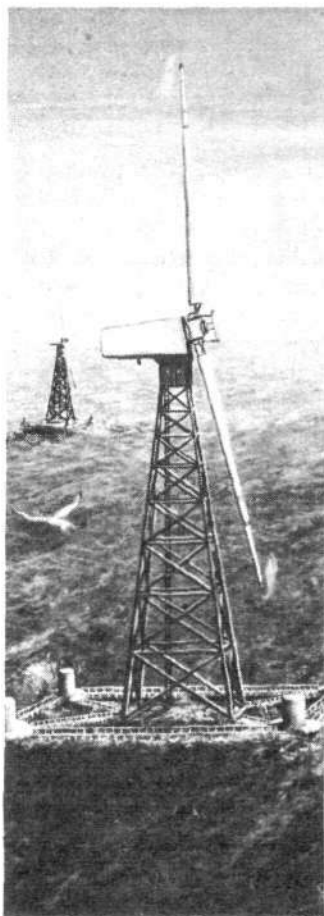

DOE

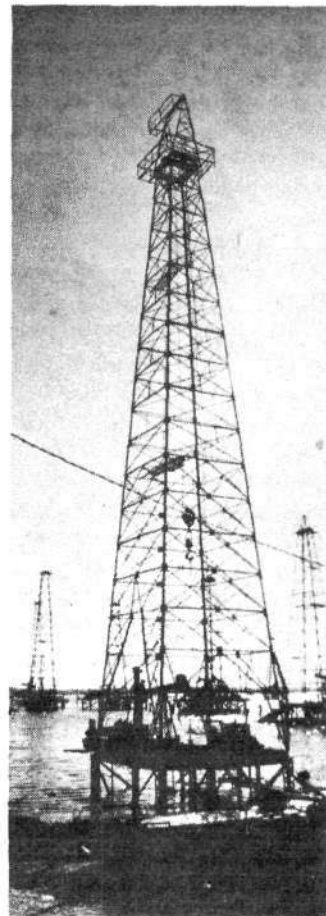

DOE

### ENERGY FLUX DENSITY

Energy source	Power density (kilowatt/meter <sup>2</sup> )
Solar—biomass	0.0001
Solar—earth surface	0.2
Solar—near solar orbit (5 million miles)	1,400
Fossil	10,000
Solar at sun surface	20,000
Fission	70,000
Fusion (early commercial)	70,000
Fusion (theoretical limit)	trillions of megawatts

### COMPARISON OF DELIVERED ELECTRIC POWER

	Total energy costs  (mill/kw-hr)	Total energy price	Capital invest- ment (billions of \$)
Oil	25.1	45.7	0.94
Coal	24.2	31.7	0.97
Coal gas	41.7	55.7	1.67
Light water reactor	27.8	28.5	1.16
Liquid metal fast breeder	33.7	33.9	1.43
Fusion	45.2	45.2	1.92
Solar collectors	490.0	490.0	20.9
Solar cells	680.0	680.0	28.9

Even the Department of Energy has to admit that windmills, such as those shown in this artist's drawing, are not economical. The table of energy flux density shows why: Wind power (solar, earth surface in the table) as an energy source has an insignificant power density compared with fossil fuel.

Energy flux density is measured, in first estimate, as the number of calories passing through a standard unit of cross-sectional area of the energy-producing process, such as a square centimeter or square foot.

#### Solar Vs. Nuclear

For example, conventional fossil-fuel and nuclear energy production is about 10,000 times more energy-dense than solar energy, and about 1 million times more energy-dense than use of the solar-biomass cycle for energy production. Potential cost of energy correlates inversely with energy flux density. That is, solar energy is intrinsically 10,000 times less efficient in total effects than nuclear-fission energy production today, whereas the solar-biomass programs are about 1 million times less efficient, overall, than nuclear-fission programs.

"Overall efficiency" is a combined matter of direct costs and indirect costs, such as effects on the biosphere. Solar and solar-biomass programs are 10 to 100 times more costly than conventional energy production, and when the added costs are compounded with indirect costs to the biosphere, solar-biomass programs are about 1 million times more costly to humanity, overall, than conventional fossil or nuclear production of energy.

The table compares the apparently direct costs of production of various modes of energy production, comparing energy flux densities of those modes with the capital factors of energy production as such. There we see that the direct costs of capital for solar and solar-biomass energy production are between 10 and 100 times

as much as for conventional fossil-fuel and fission-nuclear energy production.

#### The Case of Brazil

Now, by what reasoning do we prove that the combined direct and indirect costs of low-grade solar and solar-biomass programs range between 10,000 and 1 million times those of fossil and nuclear energy programs?

Let us introduce this point by considering the case of Brazil. Brazil, under orders from international bankers and U.S. administrations, has reduced its use of petroleum, coal, and nuclear energy development by relying on cutting down the Amazon rain forest. Under this program, charcoal, instead of coal, has been used to make steel—back to the 16th century's energy technologies!



Under this program, over 100,000 square miles of the Amazon rain forest were destroyed for the combined purposes of attempting to create labor-intensive agriculture and of burning wood as a basic energy source. As history should have warned any sensible person, the labor-intensive exploitation of rain-forest regions for agriculture quickly transformed the leached-out soil into an untillable mineral hardpan called laterite. That happened, as should have been foreseen.

It is also the case that major weather systems of the world are created and maintained by large-scale transpiration of moisture from plants. Cutting down the Amazon shifted the Amazon high out into the Atlantic, and produced a worldwide chain reaction among weather systems, with disastrous effects for Brazil and numerous other regions of the world.

It is that sort of secondary effect that points one's attention to the massive factor of indirect costs of resorting to such lunatic energy policies as solar or solar-biomass.

The reason most laymen, as well as inadequately educated engineers and others, might fall into the delusion of tolerating such programs as solar or solar-biomass is that they are ignorant of the magnitudes of the kinds of secondary costs we have illustrated through citing the Amazon case, and have no knowledge of the special principles of energy-economy that must be applied to living systems, such as the biosphere generally, or the energetics of human society most emphatically.

In living systems, it is utterly incompetent to limit our attention merely to the raw energy throughput. All living systems' energetics are based on the ratio of what is termed "free energy" to total energy throughput. In the aging of human organs and tissues, one of whose by-products is cancer, the energy characteristic of tissue degradation involved is a drop in the potassium-related ATP production of free energy within the cell. Similarly, all studies of the biosphere and human societies as energy systems must concentrate on the ratio of free energy to total energy throughput, as well as the sheer energy flux

density of energy throughput as a whole.

In living systems, our emphasis is on not only the rate of free energy, but the rate of increase of free energy as we proceed from lower-ranking living systems to more highly developed living processes. The rate of increase of the free energy ratio so defined is known by the technical term "negentropy."

In all living systems, human society most emphatically, the quantity of energetics to be measured is not some scalar amount of raw energy throughput, but the negentropy of the system and changes in the negentropy of the system.

---

*'Government under the American System protects the level of profits of technologically progressive free enterprise in agriculture and industry by providing protected orderly markets of the sort required to maintain such profit levels.'*

---

Therefore, the indirect costs of using solar and solar-biomass energy programs are properly measured as decreases in the negentropy of both the biosphere generally and human society in particular. There is a special case of such indirect costs, in which the negentropy of the biosphere as a whole ceases overall such that a vector of entropy, or devolution of living systems, occurs. In this state of devolution of the biosphere, some forms of life continue to maintain at least a limited energy prosperity by evolving as dominant parasites and saprophytes destroying higher forms of organisms. This correlates with the outbreak of new kinds of pandemics in the forms of pests, human pandemics, animal pandemics, and pandemics of vegetable life, termed "sylvatics."

It happens that the world's weather systems are a by-product of relatively negentropic processes within the biosphere generally. Thus, the devolution of the biosphere of Brazil by lunatic solar-biomass economic doc-

trines led to a degradation of the world's weather systems.

Whenever we remove organic vegetable and animal waste from the biosphere, we lower the energy flux density and negentropy of the biosphere. We must add relatively high-energy inputs to the soil to compensate for this, in the form of fertilizers and essential trace elements. The latter are the essential catalysts of negentropic energy production within the plant cell.

The way in which the biosphere maintains its vitality is through, chiefly, the role of chlorophyll and related processes in converting sunlight from "inorganic" into negentropic forms of organization of energy. This provides the basis for a human-habitable biosphere (oxygen replenishment, carbon dioxide reduction, stable weather systems), and also supplies the basis for the essential food chain of other plants, animal life, and human beings.

Thus, although solar and solar-biomass programs of energy production are lunacy because of the extremely low energy flux density of such modes, the indirect costs of such lunacy are far greater than the direct costs. Solar energy is indispensable to the biosphere's energy cycle because of the conversion of that energy into negentropy fueling the planet's entire life cycle. Whenever any government is criminally foolish enough to divert large parts of that flow of energy in the forms of solar energy or solar-biomass withdrawals from the biosphere's needs, the devolution of the preconditions for continued human life must result.

The indirect cost of such lunatic programs as solar and solar-biomass for society is to be measured as the cost to society of replacing the negentropy destroyed by the absurd solar and solar-biomass programs' effects.

#### **Applying Riemannian Physics**

Similarly, as the LaRouche-Riemann computer-based studies of the world and national economies prove conclusively, the reason for the need to apply Riemannian physics (the most advanced physics in the world today) to analyze and forecast economic effects is that the economies of human society are ruled, in the final analysis,

by the same principles of negentropy encountered in management of the biosphere.

The portion of net profit invested to effect capital-intensive increases in the technology of production, the source of all advances in productivity, appears in the energy accounts of society as the portion of total energy throughput corresponding to free energy. The investment of that free energy in the indispensable, capital-intensive way results in increases in the true depreciation per person productively employed. It is net profit that enables us to increase the ratio of true depreciation still further, as the conversion of free energy (profit) converted into higher levels of productive capital.

The density of true depreciation in an economy, or principal subsector of an economy, is equivalent, in broad terms, to an increase of the temperature of an energy-producing system. In the case of the energy-producing system, the higher the operating temperature the greater the potential efficiency of the system. In the case of an economy, the higher the "temperature equivalent" in the form of true, energy-dense depreciation levels the greater the potential productivity of that economy.

In other words, the investable net profit of agricultural and industrial producers is the true first cost of a healthy economy ... on condition that those profits are competently invested in technological improvements in the productive cycle.

Therefore, government under the American System protects the level of profits of technologically progressive free enterprise in agriculture and industry, by providing protected orderly markets of the sort required to maintain such profit levels for progressive firms and farms, and uses the tax policies of the government to tax heavily nonproductive use of profits while providing tax benefits for job-creating productive investment in advanced technology.

It is true that technological improvements lessen the amount of direct labor required to produce any fixed quantity of product, but the expansion in levels of production of capital goods absorbs those displaced

from one industry into expanded production of such capital goods.

True, under Jefferson, Jackson, the effects of the 1879 Specie Resumption Act, and the Federal Reserve System, the United States has drifted far away from the principles of the founding fathers' American System of political-economy. Today, the United States no longer has its own national currency—a group of international private bankers controlling the Federal Reserve System owns our currency, and more or less our federal, state, and local governments as well. Our public as well as our private debts are chiefly owned by the same supranational private banking interests, who

---

*'Whenever any government is foolish enough to divert large parts of the flow of energy in the form of solar energy or solar-biomass withdrawal from the biosphere's needs, the devolution of the preconditions for continued human life must result.'*

---

use control of those debts to dictate the policies of the federal, as well as state and local governments. Our republic has surrendered all efficient self-government over those aspects of policy that most efficiently determine the conditions of life and opportunities for the individual citizen and private entrepreneurs.

Through the British doctrine of "free trade," anarchic competition and international bankers' control of our nation's principal supplies of credit drive the profits of our producers down to submarginal levels. "Free enterprise" as established by the founding fathers is being wiped out by Professor Milton Friedman's "cannibalistic competition" doctrines, doctrines that have led to Nazilike dictatorship in Chile and that Professor Friedman proudly announces he has copied from the policies of Nazi Finance Minister Hjalmar Schacht plus the policies of the world's central drug-running entrepôt of Hong Kong.

This is what the Nazilike Friedman and his foolish admirers term the "economics of freedom"!

#### **The American System**

Under the American System, it is the obligation of the federal government to establish a system of national banking, which issues a government-regulated, gold-supported currency in the form of United States notes. These notes are not passed out like mimeographed leaflets on streetcorners; they are loaned through the local private banks of the nation. Those banks, using borrowers' equity as a margin of security, lend deposited savings to worthy borrowers. The national-banking system then makes available supplementary medium- to long-term lending funds by taking as much as 60 percent of the total loan given against security—against the account of the increase in national tangible wealth effected by prudent loans.

By gearing the additional issues of U.S. notes to the amounts that local bankers consider worth lending to worthy borrowers in terms of their own private-banking deposits loaned, the currency policies of federal national banking limit the currency issued to exactly the amount that investors and bankers can and will employ to make full productive use of otherwise unsold capital goods and otherwise idled capital-goods-producing capacities.

Since such loans through the private banks to worthy borrowers pledging their own equity are fully secured, and since improvements in productivity cheapen the costs of production, proper government issuance of U.S. notes produces a deflationary trend in commodity prices and a rapidly expanding economy (and productive employment) at the same time.

By shaping tax policies to encourage savings by ordinary households, and to provide tax incentives for productive investments, with tax penalties for the incomes of wastrels, the laboring and producing portion of our citizenry prospers, while those citizens inclined to investments in Sodom and Gomorrah become the targets of emphasis for the federal tax-gatherers.



In that way we shape a national economy in which the individual citizens live modestly but well, putting the savings in excess of household-consumption requirements into those productive investments that cause the national economy to continue the cycle of upward-moving prosperity.

Let us apply these principles to the special case of designing a proper inheritance-tax policy for the farms of independent owner-operated agriculture.

Clearly, unless we are a nation of lunatics, we do not wish to let inheritance taxes liquidate our independent owner-operated farmer strata. Therefore, the inheritance-tax policy should not touch the tangible assets of the farm in transmission by deed or will to another farmer. If the heir were to attempt to liquidate the farm, then the inheritance tax should fall upon the heir under that condition and at that point.

The same principles ought to apply, obviously, to other essential forms of privately owned or closely held corporate producers. It is wasteful spending, not productive investment, that should be taxed heavily. As long as a firm's assets are "tied up" in productive capital that employs productive labor, producing wealth adding to the national total, it is in the national interest to keep that entity intact. If the management and ownership lead the firm into bankruptcy, then the proceeds of the sale become taxable.

That illustrates the way in which maintenance of parity values through orderly marketing approaches combines with proper credit and tax policies to ensure that the net profits fostered by such policies are either invested as intended or become subject to the corrective action of relatively high rates of taxation.

This is not a "subsidy" for obsolescence or incompetence. The nonproductive producer, the mismanager, will eliminate himself by failing to keep his costs in line with those of the competitive producers on whose performance competitive standards of cost are based in calculating parity values. Nor need we engage ourselves in "land bank" and related sorts of programs. There is a shortage of food



USDA

*The greater the ratio of energy input in the form of "artificial labor" to human muscle power, the greater the productivity of labor and the better the possible quality of the product being produced. Here, Mexican peasants use muscle power in a "food for work" program.*

on the world market relative to human needs, and marginal production in agriculture is not profitable, even at parity values.

#### **The Government's Role**

The federal government's role must be this. The government must negotiate treaty agreements concerning world-market parity and projected volumes with nations. The government must secure treaty agreements covering 3- to 5-year volumes, prices, and credit arrangements for marketing of U.S. agricultural products. At that point, the State Department's role in the matter diminishes, and the Agriculture and Commerce Department's role predominates. The Agriculture Department, working in conjunction with the Export-Import Bank, aids the marketing of exports, and the two intervene jointly into domestic markets to keep price movements orderly with the predetermined projections for an orderly market at parity values.

Through cooperation with other nations in promoting programs of world-market parity to encourage improvements in agricultural output and productivity relative to growing world food needs, medium-term, 3- to 5-year share-of-market and price treaty agreements are negotiated, and long-term projections of estimated market and price are continually updated as encouragement for long-term investments.

Orderly market, parity, credit, and

tax policies thus represent a total package by which the federal government fosters the private initiative of the owner-operator farm with the minimal intrusion into the private sector. By using the Agricultural Extension Service and complementary channels of consultation with owner-operator farms, the development of accurate marketing commitments, worked out by farmers in a way needed for individual farmers' decisions on agricultural product programs, will accomplish more than all the bureaucratic sorts of regulation. Accurate information exchanged between government and farmers, and government cooperation to maintain orderly markets in keeping with such accurate estimates, is the approach consistent with the American System.

The government's interventions into markets will involve maintenance of adequate strategic reserves, both for reserve emergency needs and to aid in balancing-out poorer and better crop years. Otherwise, government intervention should emphasize export requirements, accelerating and delaying governmental action in the manner of a grain handler to keep the flow at approximately parity values.

The notion that less-than-parity prices mean cheaper food is the delusion of a fool who lives only for the next moment and sees nothing of the consequences of his foolish decision for the year or so immediately ahead.

First Global Conference on the Future, July 20-24, Toronto

# World Futurists Turn Back the Clock

by Mark Burdman

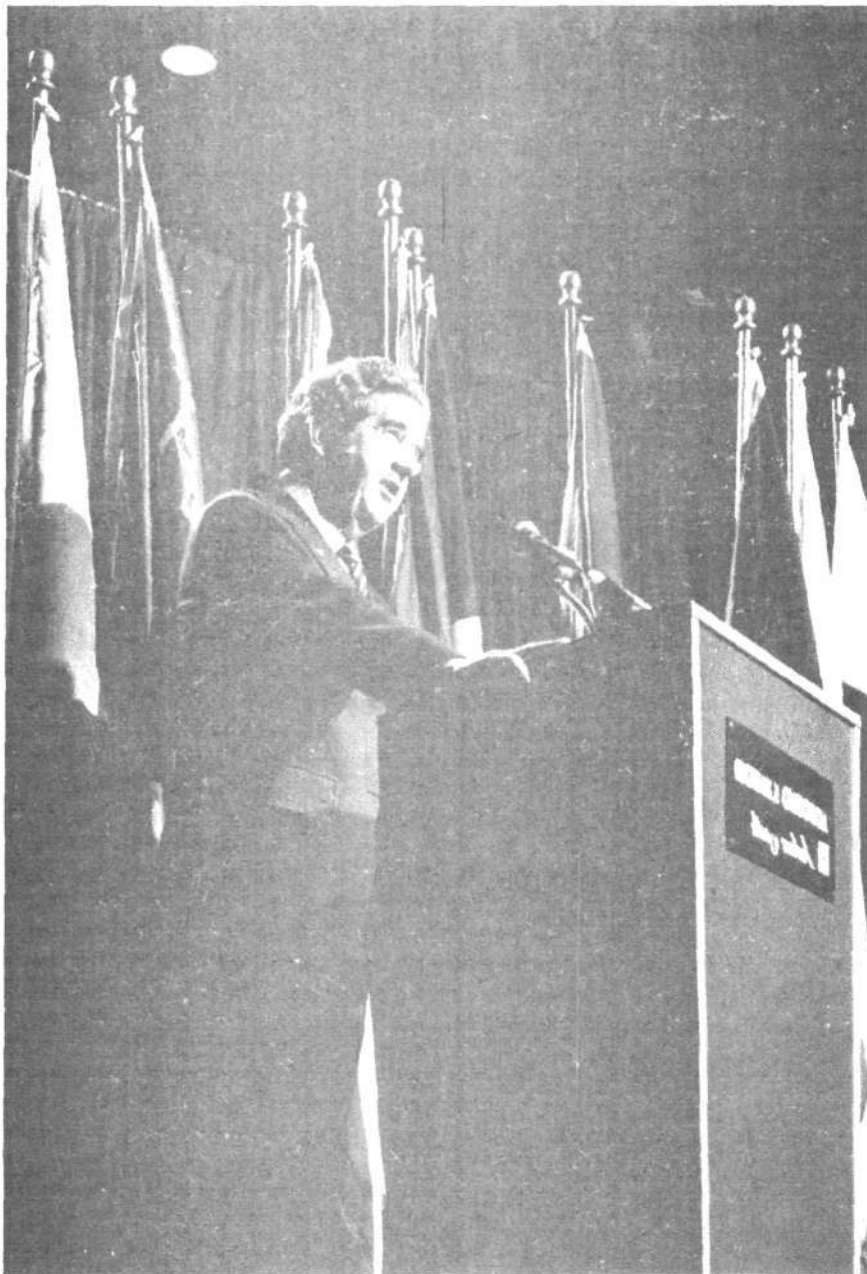

Photo by Tony Cornish/World Futures Society

Willis Harman giving the Toronto keynote: Industrial society is "out of step" with the North American Indian.

In the September issue of Fusion we featured a shocking exposé by Mark Burdman of how the Club of Rome and NATO planned to kill U.S. science. This geopolitical blunder of a leading U.S. political-military faction launched the 1960s-1970s "Limits to Growth" campaign to con the Soviet bloc (and the Third World) into containing its scientific development. In the process of substituting political and psychological levers for industrial and military strength, the U.S. scientific capability was gutted.

Here the same author presents an eyewitness account of the Toronto Futurists conference, a gathering that embodies the Aquarian product of the Club of Rome policy.

\* \* \*

Why is the United States becoming a second-rate power? The First Global Conference on the Future, held in Toronto July 20-24, provided abundant evidence for two divergent explanations. Either the corporate boardrooms of IBM, Xerox, Control Data Corporation, General Motors, and many leading banks and oil companies have been infiltrated by KGB moles who are successfully subverting capitalism by boring from within, or there is an influential U.S. faction that has successfully conspired to turn back the clock and destroy 200 years of American tradition.

There are two points to emphasize at the outset. First, the futurists are neither an innocuous group that makes predictions about man's future nor simply a bunch of kooks. Second, behind the futurist movement lies a conspiracy—a concerted policy effort by a definable political faction.

This must be made absolutely clear. For unless the majority of Americans, who support high technology, nuclear power, industry, and the idea of progress, are prepared to combat on the highest level the evil that the futurists represent the forces for progress will lose the battle.

While these skeptics prefer to characterize the futurists et al. as a "kook" movement that will go away because



sane people will not support it, the conspirators are successfully ensuring that the zero-growth Aquarian philosophy become the controlling force in American society.

### The Aquarian Future

What will the future be like in the eyes of these futurists? The atmosphere at the five-day Toronto event was akin to the staging of the musical "Hair," an "Aquarian Age" spectacular in which 6,000 participants from 45 countries celebrated the devolution of scientific and technological progress. Under the conference theme "Think Globally, Act Locally," attendees were barraged with propaganda to return to their communities to organize for a new global "conservator society," characterized by a turning away from "materialistic values" and respect for the nation-state toward a "spiritualist," "one-world" order.

This Aquarian philosophy was covered with the mantle of respectability by the event's prestigious backers.

This First Global Conference on the Future was sponsored by the World Futures Society, on whose board of directors sits Sol Linowitz, formerly of Xerox and now a Carter administration special diplomatic envoy; Michael Michaelis of Arthur D. Little; and former agriculture secretary Orville Freeman of Business International.

Official corporate sponsors were equally respectable: for example, Bell Canada, Control Data Corporation, Dresser Industries, General Motors of Canada, IBM Canada, Imperial Oil, Kodak Canada, Petro-Canada, Royal Bank of Canada, Shell Canada, Sun Oil Company of Canada, Trizec Corporation, Sun Life Assurance of Canada, and Xerox of Canada. Several Canadian government officials and the United Nations also played a sponsoring role.

This prestigious sponsorship, albeit often unknowingly, provided an aura of credibility for the likes of conference leader Willis Harman, the Stanford Research Institute social theorist whose experiments with psychedelic drugs and "altering belief structures"

have made him a leading voice in the Aquarian Conspiracy. Harman delivered the conference keynote lambasting the "materialist view of industrial society" with its "concept of humankind controlling and exploiting an insentient world" and its "increasing linkage between science and technology."

---

*'We are building our house on sand if we base our future on technology.'*

—Rashmi Mayur, futurist from Bombay, India

---

This viewpoint, Harman asserted, is "out of step" with "the perception of the North American Indian," a perception that "may be emergent as an ecological perspective in some of the contemporary social movements around themes like conservator society, development alternatives, appropriate technology, holistic health, and alternative lifestyles."

Harman was preceded by an interfaith religious service that began with a blessing from the Cree Indian tribe, because, a conference coordinator explained, "as the original inhabitants and stewards of the land, the Crees have a message for us all. . . . In this, the postindustrial space age, new ways are needed. . . to break through the rationalistic prison that Western man has been bound up in for hundreds of years."

The message continued into the next day's plenary. Conference award recipient Bertrand de Jouvenel, a disciple of the acknowledged "father of futurism" H.G. Wells, attacked the longstanding "equation of progress with capital investment" and proclaimed that "the good direction is respect of life: animals and vegetables and fishes, especially whales."

In the emergent global context, de Jouvenel insisted, "The United States can be a helper, but not an example, and we must put this into our heads."

De Jouvenel was seconded by lead-

ing futurist Hazel Henderson, who attacked "machismo technologies" and "patriarchal nation-states" and called for the 1980s to become the "dawn of the Solar Age" through a "trial by entropy." "Let us respond to the emerging awareness of ourselves as conscious parts of the earth, of the mysterious, self-organizing Earth-Mother," Henderson pleaded.

At the closing plenary session, conference chairman Frank Feather, a director of the Canadian Association for Futures Studies, declared that Harman and Henderson, along with futurist Rashmi Mayur from Bombay, India, had "personified the theme of the conference throughout the week." Mayur returned the compliment by closing the event with two injunctions: "The American Indians are the ones who are the basic inspiration for the future" and "We are building our house on sand if we base our future on technology."

### Postindustrial Suicide

Given this sampling from the proceedings, the obvious question the reader might have is why do respected corporate and policy-planning elites sponsor and promote the Aquarian ideology whose proliferation amounts to suicide for the United States and its Western allies?

The immediate answer lies in the extent to which the Club of Rome International and its cothinkers at the Sussex University Tavistock Institute have won a significant faction of the NATO elite over to the nonsense-theory of the "postindustrial society."

For example, World Futures Society directors Linowitz and Michaelis are members of the Club of Rome International and the affiliated U.S. Association for the Club of Rome, respectively. And conference chairman Frank Feather admitted that the Toronto conference was inspired by Aurelio Peccei's speech before the Canadian Association for Futures Studies two years ago.

Peccei, who gave two major addresses at the Toronto event, is the founder and executive director of the Club of Rome International, the organization that sponsored the *Limits*

## Conferences

to *Growth* psychological warfare early in the 1970s. Peccei has stated bluntly that he sponsored the *Limits to Growth* project in order to "shock" the populations of the western world into accepting a top-down reorganization away from industrial growth and into a "postindustrial" or "technetronic" society, a term coined in the 1960s writings of U.S. National Security Council director Zbigniew Brzezinski.

The mid-1960s conception of Brzezinski and Peccei evolved from a desire to undermine the scientific progress generated by the NASA space program and to skew NASA-associated technological breakthroughs away from industry and in the direction of sophisticated communications grids and other technologies oriented to information- and mind-control.

### H.G. Wells and Tavistock

Historically, this policy direction came from H.G. Wells, Peccei's mentor. During the 1920s, Wells strongly encouraged the advance of the advertising and propaganda aspects of the new communications industry, as the basis for new means of population manipulation and for the evolution of what he called a "world brain" (or "open conspiracy") of like-minded elite intellectuals. (Today the Aquarian devotees of Wells call this "networking" or a Global Futures Network.)

Wells's ideas were key in evolving the supercommunications-dependent methodologies of the British Special Operations Executive during World War II and in shaping the postwar evolution of the Tavistock Institute, center of British psychological-warfare operations.

Tavistock is the mother institute for a series of U.S.-based institutes (the Rand Corporation, Stanford Research Institute, and so on) that have elaborated the "postindustrial-society" concept. Tavistock was also behind a series of mid-1960s "Year 2000" projects that popularized the "postindustrial society" theme.

Leading multinationals such as IBM, Xerox, and ITT have either funded

major work at the Tavistock-affiliated U.S. think tanks or are well-populated with strategic planners who have had training at these think tanks. These corporations made a crucial series of decisions during the late-1950s U.S. recession to develop the "information-society" variant on the "postindustrial society."

The massive expansion in television, advertising, telecommunications, and

---

*'Let us work with the opponents of the space program to deal with the limits that imperil the space program.'*

—Donald Tarter

---

movies, as well as the promulgation of such neofeudalistic theories as McLuhan's "Global Village," have been the surface manifestations of this economic policy, which has necessitated a corresponding belief structure appropriate to a society converging on Huxley's *Brave New World* and Orwell's *1984*.

The July 1980 Toronto conference was an example of that belief structure in action.

### Antiprogress Philosophy

The Tavistock/Club of Rome promotion of the postindustrial information-society process from the beginning has had a close symbiosis with the antiprogress Aquarian ideologies for postindustrial theory claims that societies are leaving the industrial era and must replace the values associated with industrial development with a belief structure appropriate to a new paradigm.

The postindustrial-Aquarian symbiosis feeds on the claim that industrial societies must be phased out because they are "depleting the earth's resources." Whether Peccei, a Fiat magnate, and his colleagues in the corporate-NATO command-structure really believe this or whether they circulate it to force through their end-goal of a communications-focused "Global Village" society, they have

constructed an elaborate superstructure based on the theme that "an information society saves resources."

Thus, in the Toronto conference closing-keynote address, Canadian energy magnate Maurice Strong urged interest in the "microelectronics revolution" because "microprocessors save energy." Strong, a former top official in the United Nations, is a director of the Aspen Institute and of the appropriate-technology Lindisfarne Association.

Hence, too, the line from Robert Hamrin, a White House economic advisor and staff member of the Environmental Protection Agency, who spoke at a Toronto conference panel on "The Management of Economic Opportunities in a Time of Constraints": "The influence of industrialization and capital-intensive production should be lessened in the upcoming information economy."

In the emerging new era the very concept of a resource will be redefined: "Just as capital and labor frame the problems of an industrial society," Hamrin wrote in his seminal new book, *Managing Growth in the 1980s: Toward a New Economics*, "information and knowledge will frame the problems of postindustrial society."

According to Hamrin, the information society is not a concept, but the characterization of what American society is now and is becoming. Fifty percent of the workforce, he claims, is currently engaged in "information-related" activities, while only 20 percent is involved in industry. Furthermore, a document no less significant than the 1976 President's Report on National Growth and Development has officially acknowledged this phenomenon as the vector of the U.S. economy: "The U.S. 'postindustrial society' is coming to be recognized as a services economy in which the dominant feature is information."

This report, Hamrin noted, "singled out computers and communications as vital growth industries now spawning an economics of abundance in our information resources rather than the economics of scarcity that tends



to characterize energy and other natural resource sectors."

Hamrin concedes that an extensive social-engineering apparatus has been brought to bear to *persuade* Americans to break with their passionate historical commitment to industrial growth: "The consensus that has arisen in such a short time on the dominance of social limits to growth and their impact on growth beginning in the 1980s is so complete that it almost smacks of conspiracy."

#### **Undermining Science**

That the Aquarian conspirators have been able to convince scientists to participate in their campaign to gut U.S. science was demonstrated in the three panels on the U.S. space program, which occurred without a whimper of protest from the scientists and engineers present. The message to scientists was to work with the Malthusians and neo-Malthusians on common goals—such as exploring space—to plan a space program within the constraints of an austerity economy.

As for fusion, a real and exciting option for the future that promises unlimited energy, there was barely a mention (see box).

At a forum on "Long-Range Space Goals," for example, retired NASA rocket scientist Konrad Dannenberg appropriately assailed President Carter's inadequate space program and European Space Agency representative Jan A. Bilvoet gave a factual presentation on the space lab program.

But then University of Alabama (Huntsville) sociologist Donald Tarter gave a ranting speech on how "Malthusian realities" on earth could force the triaging of the space program altogether.

"We must acknowledge earthly limits and constraints," Tarter said. "Prospace groups should increase the awareness of their members of limits. At the same time, the Malthusians and neo-Malthusians should work with Herman Kahn [think-tanker who proposes zero growth in the "affluent" sector and growth in the Third World]. . . . Technology is on trial with

the public after Three Mile Island. There is fallout from Three Mile Island on Huntsville and Cape Kennedy. Let us be cautious. Let us not let dreams outpace reality. Let us work *with* the opponents of the space program to deal with the limits that *imperil* the space program."

This insane policy of Malthusian dialogue was reinforced in the panel on "Space Industrialization." Here space affairs expert Charles Chafer of the Public Affairs Council in Washington responded to the question, "How do we deal with advocates of a decentralized soft-energy path when we are arguing in favor of a centralized space program?" by stating:

"Tailor your arguments to their bias. Decide it on a technology-by-technology basis. Not all the technologies of the space effort are adverse

to the desires of the soft-energy advocates. This is a form of conflict resolution, developed at the Department of Energy, under the name of environmental mediation, to work with the environmentalists."

It is hardly accidental that the futurists are pushing such a policy of mediation and dialogue at the same time that White House Science Advisor Frank Press announced in congressional hearings that the space program must be sacrificed in the face of growing economic problems.

#### **Mind Versus Mush**

Many scientists succumb to the Aquarian ideology because they accept the Aquarian claim to ideological monopoly over the processes by which the human mind operates.

The Aquarian view, the dominance of irrationality over reason, was

## **No Fusion in Futurists' Future**

The Toronto conference organizers gave short shrift to any discussion of the single, most viable and exciting option for the future: the development of thermonuclear fusion power.

Only one of more than 100 presentations at the "Energy Track" seminars held throughout the week had fusion as the main subject. And this presentation by Argonne Laboratory scientist Mohammed Abdou was "counterbalanced" by an antinuclear activist from Toronto.

Another *planned* discussion on fusion never took place because the listed speaker, Dr. Stephen Dean, president of Fusion Power Associates, was not present at the conference, and had never agreed to speak there.

Only one speaker out of 25 or so plenary speakers, Marvin Cetron of Forecasting International Ltd. in Arlington, Virginia, mentioned the fusion option. At the last day's plenary session Cetron declared: "We need fusion power. It's the best option we have. It will get us into a position where we'll never be hostage because of energy again. That's where we should spend our money."

As soon as Cetron finished, the next speaker, World Bank economist Mahnub el-Haq of Pakistan, declared: "I totally disagree with his solution"—and that was the last mention of fusion at the event.

Certain key conference figures were overtly hostile to the idea of development of thermonuclear fusion power. Futurist Hazel Henderson, for example, proclaimed herself to be a "veteran of the fusion holy wars in Princeton," where, she admitted in an interview, she had been a staunch opponent of the tokamak fusion reactor project headed by Dr. Melvin Gottlieb.

Henderson called support for the fusion option "whistling in the dark," and denounced "blind faith in far-out technological fixes and machismo technologies."

## Conferences

spelled out by Willis Harman: "There has recently appeared some compelling evidence that the equating of mind with brain, as is implied by much of contemporary science, is a limiting and distorting concept kept alive by a materialistic belief system."

Harman and others counterpose the "rationalistic-materialistic West" to the spiritual "West" or to the spiritual American Indian. Science has become divorced from spirit (soul), by erecting the straw man of British empiricism and the European Enlightenment (Newton-Locke-Francis Bacon) and equating this with science. This "science"—which is really nominalism and just as irrational as the Aquarians—is then proven to be against spiritual values.

This fraud works only to the extent to which the Aquarians' forebears have been able to obliterate the history of real scientific progress contained in the line of thinkers running from Plato in ancient Greece through Ibn Sina (Avicenna), Roger Bacon, and Nicholas of Cusa on through Leibniz and the 19th-century mathematicians Cantor and Riemann.

This line of Platonists holds that man demonstrates his atonement with the Creator through scientific work. Scientific and technological advance is that activity through which man participates in the work of God the Creator, perfecting the ongoing process of creation. Scientific breakthroughs demonstrate the efficiency of the Creator's laws on earth and for mankind, and thus man is enjoined to pursue this work with full commitment.

From this vantage point, "science" and "spirit" (soul) are hardly distinct and opposed, but are a unity, with spirit serving the role of emotional force, giving life to the impulses of science and reason.

Reason is a domain that is transfinite, relative to both inorganic and organic life. In this domain of Reason, as is demonstrated by Riemann's establishment of the coherence between shock-wave phenomena and the mentative process of the higher



*Aquarians' Public Enemy Number One: the pamphlet commissioned by Lyndon LaRouche.*

hypothesis, mind and brain are a unity—a unity whose active principle is subsumed by the transfinite processes of Reason.

Since Willis Harman and his futurist cothinkers cannot access the powers of Reason, they have to fall back on all sorts of mumbo-jumbo to reify the way the mind operates.

It is interesting to note that Harman's chief disciple, Marilyn Ferguson, who wrote *The Aquarian Conspiracy*, singled out as the Aquarians' Public Enemy Number One FEF founding member Lyndon H. LaRouche in her July 22 conference presentation. LaRouche not only has been responsible for resurrecting the Leibniz-Riemann tradition from its premature grave, but also commissioned a widely distributed pamphlet naming the respectable names behind the Aquarian Conspiracy and quoting their own statements on their plans to end the American tradition of science and progress.

*For background information on the Aquarian Conspiracy, see: Stamp Out the Aquarian Conspiracy, coauthored by Mark Burdman, available from Campaigner Publications, 304 West 58th Street, New York, N.Y. 10019; The New Dark Ages Conspiracy, by Carol White (New York: New Benjamin Franklin House, 1980). A review of Ferguson's book The Aquarian Conspiracy appeared in Fusion, July 1980, p. 79.*

## Extra

Continued from page 9

### **Rep. Don Fuqua (D-Fl.), chairman, Science and Technology Committee, Aug. 26**

There is a need for development of inexhaustible domestic energy sources. There is a need to revitalize our technology industries. And, there is a need to maintain the United States in the number 1 international position in fusion energy research and development. There are clear signs that other countries are catching up. The Soviets have over twice as many scientists working on the development of fusion power. The Japanese are spending 50 percent more per capita on fusion than the United States, and a large share of the Japanese fusion program is already being carried out directly within their industrial sector, not in government laboratories as here in the United States. . . .

I urge all of my fellow members to fully endorse the measures outlined in this very important bill.

### **Rep. Edwin Forsythe (R-N.J.), Aug. 26**

The pace of fusion research and development is clearly limited by funds. The ingenuity, skills, and technology exist for the construction of a fusion test facility. What is lacking is funding and a nationally recognized commitment, like that of the space program of the 1960s, to fusion power that will mobilize our resources so that we may reap the benefits. I want to urge my colleagues to join me in supporting HR 6308, which will not only safeguard our future but will also insure energy independence for all nations.

### **Warren Hamerman, executive director of the National Democratic Policy Committee, former chairman of Citizens for LaRouche, Aug. 27**

The fusion bill opens the possibility for the first time in 20 years of a national scientific research program that can take the United States into the 21st century assured of the plentiful energy necessary for growth. American agriculture, labor unions, and industry should get behind the bill so that we can implement it and get the economy going again.



## In This Issue

### AGRICULTURAL SCIENCE VERSUS THE MALTHUSIANS

U.S. agriculture, the most productive in the world, is at a crossroads. The Malthusians want to send the technology-proud U.S. farmer back to a horse-drawn plow, without modern fertilizers or irrigation. Meanwhile, agricultural science is on the verge of breakthroughs that can create shock waves in productivity. With a full-scale commitment to agricultural research and high-tech, capital-intensive methods, U.S. agriculture will lead the world into the fusion age. The zero-growth road will lead U.S. agriculture back into the 19th century.

This special issue of *Fusion* reports on the crucial role of energy-intensity in U.S. agriculture; the scientific frontiers such as genetic engineering, bioregulators, and twinning in beef; the environmentalist hoax that pesticides are a menace; climatology and how we can control it; the Carter economic policies that are putting the U.S. farmer out of business; the famine in Africa; a national water plan; a program to bring U.S. agricultural methods to Mexico; and, finally, the economics of agricultural parity. The message is clear: With American agricultural methods, there's no limit to the number of mouths the world can feed.

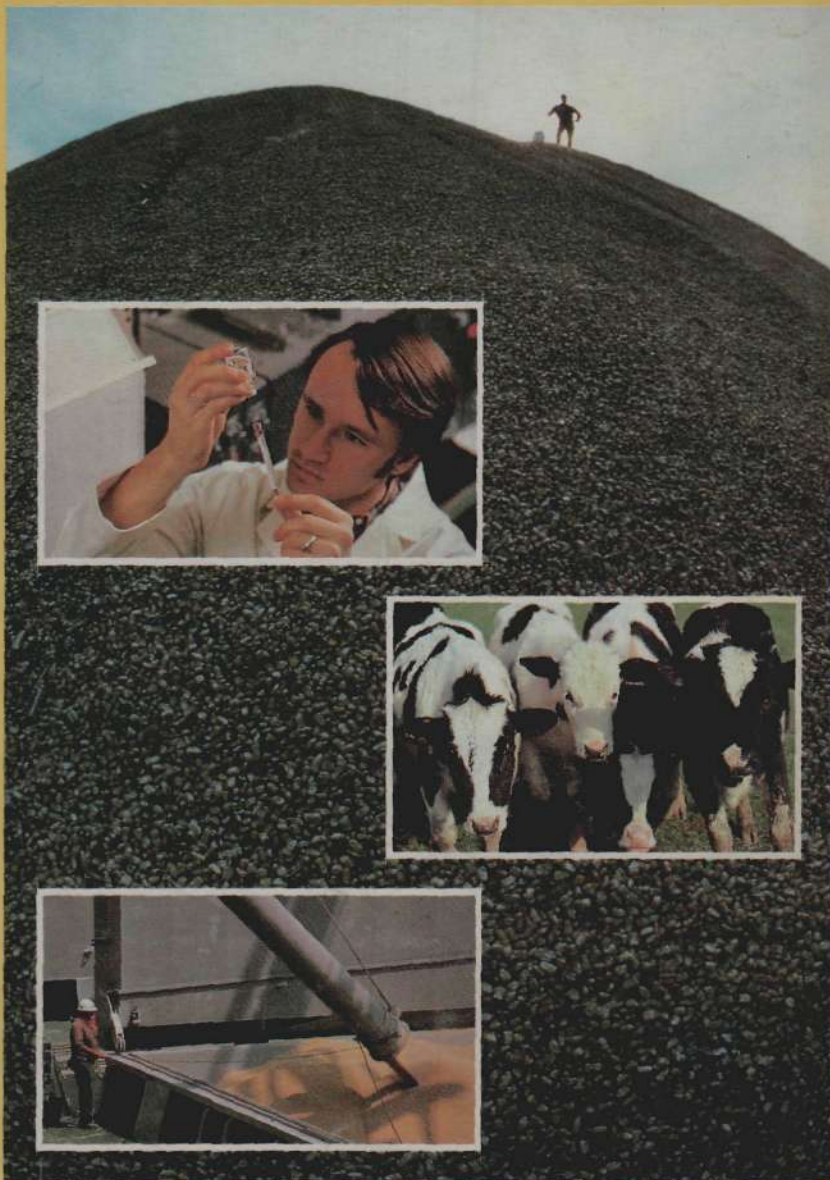

### UNDERGROUND FUSION FACTORIES

Leading European nuclear researcher Dr. Walter Seifritz proposes that we harness fusion power for energy now. Seifritz suggests that we build energy islands in remote areas where controlled underground fusion explosions would create huge amounts of energy and breed fissile fuel. The closed-cycle Hacer system he proposes would produce energy in the form of transportable liquid hydrogen, thus solving the liquid fuel problem.

**Cover:** Front cover photograph, Shostal; photograph above of grain mountain, USDA; calves by Carlos Wesley/NSIPS; laboratory and grain loading, USDA; H-bomb explosion in Bimini, DOE. Cover design by Christopher Sloan.