

# FUSION

MAGAZINE OF THE FUSION ENERGY FOUNDATION  
June 1978 \$2.00

## God Doesn't Shoot Pool

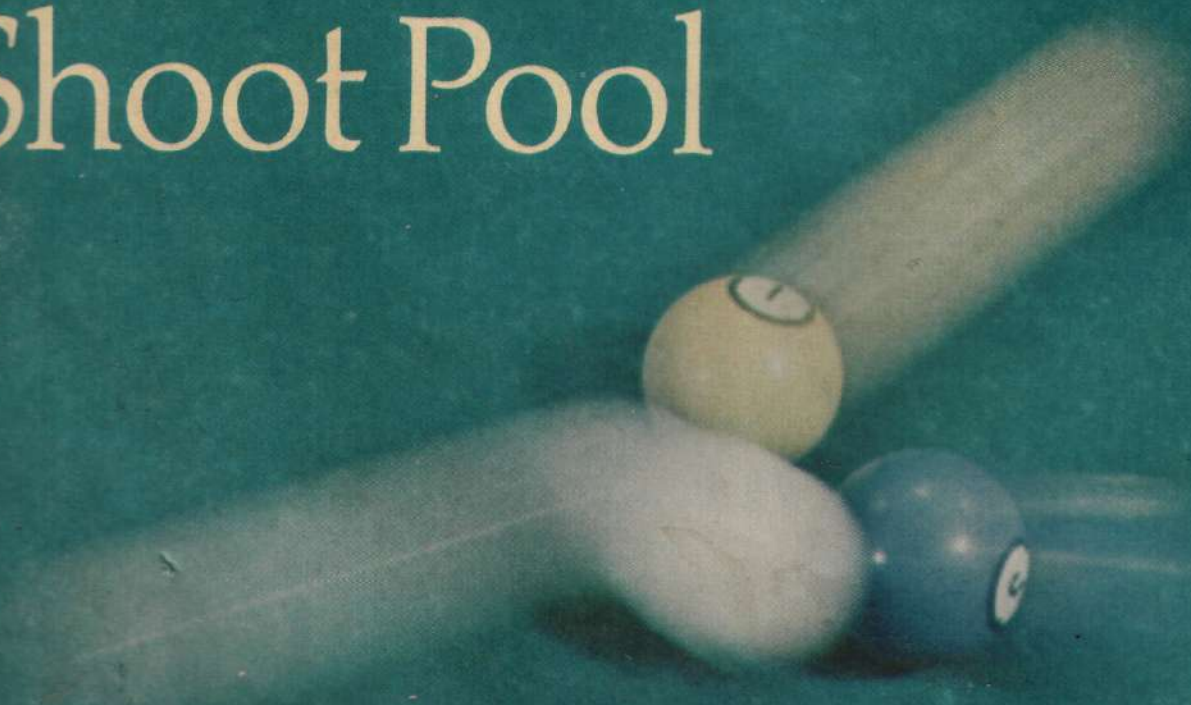

- *Solving the Three-Body Problem*
- *The Origins of Life*



# FUSION

June 1978

ISSN 0148-0537  
Vol 1, No. 8

## EDITORIAL STAFF

*Editor-in-Chief*  
Dr. Morris Levitt

*Associate Editor*  
Dr. Steven Bardwell

*Managing Editor*  
Marjorie Hecht

*Art Director*  
Christopher Sloan

*Advertising and  
Business Manager*  
Kenneth Mandel

*Circulation Manager*  
Jeanne Laudon

FUSION is published monthly,  
10 times per year except  
February and April, by the Fusion  
Energy Foundation, 231 West 29th  
Street, 13th floor, New York, New  
York 10001.

Subscriptions by mail are \$14  
for 10 issues or \$25 for 20 issues  
in the U.S.A. and Canada. Air-  
mail subscriptions to other  
countries are \$28 for 10 issues.

Address all correspondence to  
Fusion Energy Foundation, P.O.  
Box 1943, New York, New York,  
10001.

Application to mail at Second  
Class postage rates is pending at  
New York, N.Y.

The views of the FEF are stated  
in the editorials. Opinions ex-  
pressed in signed articles are not  
necessarily those of the FEF  
directors or the scientific ad-  
visory board.

Printed in the USA



Copyright © May 1978  
Fusion Energy Foundation

## Features

### SOLVING THE THREE-BODY PROBLEM

*Dr. Steven Bardwell*

21

The world cannot be described as a complex sum of billiard ball interactions.

### THE ORIGINS OF LIFE

*Dr. Ned Rosinsky*

39

Today's human beings did not evolve as a random selection from primordial soup.

### SUPERCONDUCTING TRANSMISSION: MORE POWER AT HALF THE COST

*Marsha Freeman*

46

Superconductivity can efficiently carry the power a fusion-based economy needs.

### JEAN PAUL MARAT:

#### TERRORIST MODEL FOR TODAY'S ANTISCIENCE ENVIRONMENTALISTS

*Claude Jovenal and Dr. Morris Levitt*

49

Humanist scientists like Lavoisier and Franklin were Marat's main target.

## News

### INTERNATIONAL

Japan Proposes \$1 Billion Joint Fusion Program

7

Text of Prime Minister Fukuda's Speech

7

Brezhnev-Schmidt Treaty: Peace, Prosperity, Progress

9

Pugwash Conference Calls for Fusion Cooperation

9

### WASHINGTON

Schlesinger, O'Leary Refuse to Join World Fusion Effort

10

DOE Experts Group Recommends More Funding for Fusion Research

10

Carter OK's Nuclear Fuel for India

10

Rockefeller Report Urges U.S. to Develop Fast Breeder

11

Will Industry Fight Schlesinger's Nuclear Licensing Bill?

11

NSC Staff Member Calls for Fusion Development

12

Nuclear Scientists Brief Congress

12

### NATIONAL

Sun Day Fizzles, But Administration Pushes Solar Power

13

TVA Commissioner Resigns

14

California Attorney General Hits States' Rights on Nuclear Power

14

### CONFERENCES

Detroit FEF Conference Sets Pace for Pronuclear Battle

15

Southern Africa: An Economic Solution to Apartheid

17

Music Is the Science of the Mind

20

## Departments

EDITORIALS

2

NEWS BRIEFS

5

CALENDAR

3

RESEARCH

52

THE LIGHTNING ROD

4

FEF NEWS

55

## Editorials



### 'Yes' to Japan's \$ 1 Billion Fusion Offer!

The leader of the only nation to experience the hell of atomic war has offered the world's first nuclear power the means of developing the advanced technology to provide virtually unlimited energy—thermonuclear fusion power.

The May 3 proposal of Japanese Prime Minister Fukuda to set up a joint \$1 billion fusion research program with the United States could not have been more timely. The Soviet Union and West Germany have just signed the economic deal of the century, a 25-year pact that not only furthers the prospects for peace but also opens up concrete possibilities for a renaissance of technological development. Significantly, the two nations welcome the rest of the world to join this tremendous leap forward with similar multilateral development and trade projects.

As both Brezhnev and Schmidt stressed, the agreement is not just a huge economic package that involves the development of a Siberian area larger than France, but a world-historical political event that clears a wide path of peaceful coexistence through the cold war jungle. A truly human society, the leaders said, can and must be achieved through a policy of peaceful exploitation of the most advanced technologies, not bigger and better weapons.

It is in the spirit of this agreement that Prime Minister Fukuda made his proposal to the world's most technologically advanced nation to join in an all-out project to develop fusion power. Similarly, in March the head of the Soviet fusion program, E.P. Velikhov, privately made an offer to fusion officials in Washington for the joint development of a commercial fusion reactor.

#### Schlesinger Versus World

It is striking that just as the Japanese and the Soviets have said emphatically that modern science is capable of developing commercial fusion reactors within a decade and that the U.S. is critical to world success in this effort, the leadership of the U.S. Department of Energy wants to drive this nation back to more primitive technologies. In fact, Energy Secretary James Schlesinger and the world are now on completely divergent policy vectors. Schlesinger is pushing zero-growth, conservation, and "short-term, cost-effective" energy

sources (windmills and garbage burning) at home and abroad, while the advanced sector, the East bloc, and the Third World have made a commitment to the rapid development of nuclear power and economic growth.

The Schlesinger no-growth vector must be cut short. This is perhaps the last chance in the present period for the U.S. to play its rightful leading role in world development. The realistic vision of postwar scientific-military leaders like Vannevar Bush and Henry Stimson in projecting the Manhattan Project effort as the basis for a potential U.S.-Soviet entente and the partial development of that vision in President Eisenhower's Atoms for Peace program of the 1950s must now be fulfilled.

Brezhnev, Schmidt, Fukuda, and a list of other world leaders that is growing daily have stated the problem and solution clearly and competently: The only way out of the current world depression and monetary crisis is a gear-up of the advanced sector's industrial capacity, especially nuclear power. Using a "concentric circle" model, these advanced centers would feed into the less developed areas, building infrastructure and productive capacity.

#### Fusion Key

The key to the pace of this world development in the short term is a full-speed-ahead commitment to the advanced nuclear technologies that can provide the energy to increase industrial and agricultural productivity. As the rest of the world realizes, the rate of progress in fusion development is ultimately what will determine the rate at which the overall development effort can proceed. For with the achievement of fusion, which uses the deuterium plentiful in sea water as fuel, the world will have unlimited energy.

The answer to Fukuda must be yes, just as the U.S. must say yes to Brezhnev, Velikhov, and Schmidt. The only appropriate question to be asked is why the government, private corporations, and trade unions of the world's most technologically advanced nation have not yet made such offers to the rest of the world.

## 'No' to Schlesinger's Fusion Cuts

In the past month, an extraordinary combination of new fusion supporters has come into being. Calls for vastly expanded international collaboration by the Soviet and Japanese governments, by the Pugwash Meeting in Poland, by the *Christian Science Monitor*, by CBS television, and even by a staff member of the U.S. National Security Council have put the battle for fusion right up front.

Faced with this new constellation of progrowth, protechnology forces, Department of Energy Secretary James Schlesinger and his Assistant Secretary John O'Leary have threatened to reduce the U.S. fusion research budget to a mere token. In dollar terms, Schlesinger and O'Leary have proposed cutting \$30 million from the 1979 fusion budget and \$100 million from the 1980 fusion budget (the latter sum to be added to the solar energy budget). "Fusion is too far off and can't solve our more immediate problems," is their myopic, incompetent rationale.

This is an offer that the nation must refuse!

Some staff members of the House Science and Technology Committee which recently restored the 1979 cuts in the fusion budget and voted up full funding for the Clinch River breeder reactor (over Schlesinger's opposition), have called the O'Leary proposal "pure bluff."

Whether or not the threats are bluff, the hard facts are that the present fusion research budget of \$330 million is insufficient by the Department of Energy's own calculations to get the country to technologically feasible fusion before the end of the century.

The rest of the world is not willing to wait. Neither can we.

## Calendar

### June

5-8

Industrial and Commercial Power Systems Institute of Electrical and Electronics Engineers Cincinnati, Ohio

9

Hydraulics of Cooling Water System for Thermal Power Plants American Society of Civil Engineers Fort Collins, Colo.

11-14

Canadian Nuclear Association Annual Conference Ottawa

11-15

American Society of Mechanical Engineers Annual summer meeting Minneapolis, Minn.

13

Nuclear Power for Industrial Growth Fusion Energy Foundation Paris

18-23

American Nuclear Society Annual Meeting San Diego, Calif.

19-22

International Conference on Clustering Aspects in Nuclear Structure and Nuclear Reactions Winnipeg, Canada

26-30

8th U.S. Congress of Applied Mechanics American Society of Mechanical Engineers University of California at Los Angeles

### July

5-7

4th International Meeting on Nuclear Magnetic Resonance Spectroscopy York, England



# The Lightning Rod

My Dear Friends,

Although an elder statesman who keeps his health by adhering to a strict regimen, I do find reading the *New York Times* amusing in small doses. The week of April 17, for example, produced a series of reports trumpeting the imminent demise of the calculus and its replacement by what were called sophisticated addition and subtraction computations carried out rapid-fire by computer.

Let me paint a picture of this absurdity for the layman. The calculus is not merely a branch of mathematics developed in the 17th century that has allowed for practically every advance in the sciences since then. The history of the calculus spans 20 centuries, beginning with the geometers of the Platonic Academy who taught Euclid. Every scientist and philosopher who followed in Plato's footsteps—from Archimedes, to Galileo, to Leibniz—made contributions to its development.

Why? Because by allowing us to analyze nature from the standpoint of continuous, whole physical processes, the calculus necessarily broaches the philosophical problems implicit in the existence of the Infinite. Zeno's famous paradoxes, for instance, are 2000-year-old jokes aimed at the Sophists, those Greek Empiricist foes of Socrates whose philosophical denial of the Actual Infinite (or Transfinite) led logically to the impossibility of any motion, change, or growth in the world.

Naturally, the calculus has always been a target of empiricist zero-growthers. But even John Locke, who was fully committed to destroying every glimmer of cultural development in our Colonies, knew he could not banish continuity from nature (as his degenerate Edinburgh offspring David Hume attempted). So Locke set Newton to write a calculus that would present the process of change as the fictional adding up of "vanishing" infinitesimals or "fluxions," although he knew full well that Nature cannot be summed up by such linear additions.

Today's RAND whiz kids—McNamara, Schlesinger, and so forth—operate the same way. If they cannot program worldwide industrial growth on their accountants' linear computer models, then there must be Limits to Growth, humanity be damned! A moment's reflection will provide you with the same accountant's mentality as the source for the zero-based budgeting fad that now infects Washington, D.C. (Incidentally, these accountants are now aiming their puny zero-based fluxions at the vast, nonlinear potential of fusion energy.)

Now, according to Mr. John Locke's philosophy, universal ideas have no existence. If my memory serves, our Revolution had no existence except as an idea—until we won it by outfoxing the Sophists of London and Edinburgh. (Admittedly, by losing it, we would perhaps have found ourselves lacking in existence.)

George III, who was a much stupider man than Locke, attempted a similar vendetta when he tried to make my lightning rod illegal. The Almighty, to my delight, continued to let the sparks fly as before.

The *New York Times* may think the scientific community has acquiesced so far to the zero-growthers that we will now seriously debate banning calculus from our schools. But for my part, you can tell the Infinite to go to hell, but He may send you there first!

Yr obdnt servt.

*Benjamin Franklin*

## News Briefs

### O'LEARY SAYS DOE DRAFTING REPLY TO FUKUDA

John F. O'Leary, the second in command at the U.S. Department of Energy, told a May 17 gathering at the National Press Club in Washington, D.C. that a response is being "drafted by department staff" to the recent offers by Japan and the Soviet Union to establish joint fusion programs with the United States. O'Leary declined, however, to estimate when the response would be completed.

When a reporter commented that the present U.S. fusion budget was not even sufficient to keep pace with inflation, the deputy secretary replied, "I don't see how we can sensibly spend that amount for fusion." As for the nuclear program in general, O'Leary said, "the nuclear option has faded from the horizon."

### SHAKEUP IN STATE DEPT. NONPROLIFERATION STAFF UNDERWAY

Joseph Nye, deputy to the undersecretary in charge of nonproliferation policy, has resigned his post at the U.S. State Department, and Washington sources report that a major department shakeup is underway. Several other State Department advocates of nuclear nonproliferation have also resigned, including Nye's top assistants, Lawrence Scheinman and David Hafemeister, and Philip Farley, an assistant to Special Ambassador Gerard C. Smith.

Nye was one of the chief participants who drafted the 1977 Ford Foundation-Mitre nuclear policy study that became the basis for the administration's decision to go slow with the nuclear breeder because of its supposed susceptibility to nuclear weapons proliferation. There has been increasing criticism of Nye's antinuclear approach in Washington and diplomatic circles, Washington sources report.

### ABBOUD PROPOSES MIDEAST DEVELOPMENT AS PEACE PLAN

Economic development is the "only viable alternative" to the threat of renewed military confrontation in the Mideast, the president of the First National Bank of Chicago told a meeting of the American-Israel Chamber of Commerce in Chicago May 10. Bank president Robert Abboud outlined an ambitious development plan that included the creation of a common market involving Israel and a "core nucleus" of nine Arab countries, the establishment of a central bank to fund industrialization projects, a shift from hydrocarbons to nuclear power as a prime energy source, and large-scale irrigation and desalination programs using Israel's advanced scientific technology.

Developing the agricultural potential of "Lebanon, northern Syria, the Sudan, and the Nile Valley," Abboud said, could transform the Mideast into an "exporting region for Western Europe and points to the East" such as India.

### EGYPTIAN SCIENTISTS CALL FOR NUCLEAR DEVELOPMENT

More than 500 scientists and researchers meeting in Cairo last month recommended that the Arab states develop a joint strategy for long-term energy development, in particular, nuclear power. The conference, sponsored by the Egyptian Nuclear Science Association and the Egyptian Atomic Energy Authority, endorsed the government plan proposing the establishment of nuclear power stations and recommended intensive prospecting and production of uranium. Nuclear energy is more economical and a better preserver of the environment than traditional fossil fuel sources, the conference participants said.



### FIRST TEST OF SOVIET TOKAMAK-7 A SUCCESS

The Soviet experimental thermonuclear fusion reactor Tokamak-7 completed its first test at Moscow's I.V. Kurchatov Atomic Energy Institute, in April. According to academician B. Kadomtsev, "The Tokamak-7 is close in size to the Tokamak-10, the most powerful thermonuclear installation. The difference is that it uses superconducting coils....to create the magnetic field for confining the plasma...."

During the experiment, the magnetic system was cooled to 4.5 degrees Kelvin (-269 degrees centigrade.) Because of the low temperature, the reactor with superconducting magnetic coils can run for an unlimited period, as opposed to the Tokamak-10, which has to be turned off in less than one second, so that the coils do not overheat. Kadomtsev noted that Tokamak-7 requires thousands of times less energy to run than the Tokamak-10 does.

### MOBIL CHAIRMAN: U.S. SHOULD TAKE NUCLEAR ROUTE

"If we develop nuclear power on a really large scale, by the year 2000 our country will be in about the best possible position from the standpoint of flexibility and energy security....The U.S. can buy valuable time by taking the nuclear route," Mobil Oil Corporation chairman Rawleigh Warner, Jr. told a May 3 stockholders meeting.

Warner criticized the administration's no-growth energy policy as bad for the national interest: "An expanded nuclear program would have a strong psychological impact on both the producing and consuming countries. They would see that our government's policies are designed to avert possible confrontations as competition for limited oil supplies develops. They would also see that this country had moved decisively and soundly to begin diminishing the deficit in its international balance of payments—and this would have a salutary effect on the American dollar."



### CALIF. ATTORNEY GENERAL CALLS FOR '50 NUCLEAR PLANTS'

Evelle Younger, California state attorney general, released a report in mid-May calling for the construction of 50 nuclear power reactors in the state by the end of the century at a cost of \$50 billion. The report was prepared for Younger under the direction of nuclear physicist Edward Teller and two Nobel laureates from the University of California and Stanford. Teller states in the report that if the recommendations to go nuclear are not followed, "California faces an energy crisis within a decade because of Governor Brown's reliance on conservation and alternatives to nuclear power."

Younger is a candidate for the Republican Party gubernatorial nomination and if successful will run against the Democratic incumbent, Jerry Brown.

### SCIENTISTS MUST 'GET POLITICAL'

"Every single U.S. scientist must help lead the fight for a strong America," Rep. Mike McCormack, a Washington Democrat, told an audience of 400 nuclear industry and utility representatives at the American Power Conference in Chicago April 25. McCormack's keynote address to the conference emphasized that the future of nuclear power in the U.S. depends on "every single scientist becoming political." "We can't depend on Congress—scientists must start running for Congress!...And management can't just keep complaining about Congress. They have to work with labor to put up slates for office. We have to counter the irresponsible press in this country, and the fears and superstitions of many...."

We have three major things going for us and nuclear power," the former nuclear physicist said: "The NAACP's energy policy statement, the Supreme Court's Midland decision [for the construction of nuclear plants], and the work of [administration special trade negotiator and inflation advisor] Bob Strauss."

# International

## Japan Calls for \$ 1 Billion Joint Fusion Program

Japanese Prime Minister Takeo Fukuda has challenged the United States to join with Japan in "colossal investment in human and material resources" to develop thermonuclear fusion power. Speaking May 3 before the Foreign Policy Association and Japan Society in New York City, the prime minister said he had proposed to President Carter a joint fusion development fund of up to \$1 billion.

Fukuda stressed that the key to Japanese-American collaboration is the effort by both nations to develop new technologies to lead the world economy out of the "doldrums" and to solve the problem of North-South competition over "limited resources." Such a U.S.-Japanese effort, Fukuda emphasized, should not exclude other nations committed to the peaceful development of fusion power. Japan, whose national budget allocation for fusion power research will soon exceed that of the U.S., is working with the Soviet Union in an extensive fusion program started last year.

The Fukuda offer to move the U.S. fusion effort rapidly forward and a similar offer made privately to Washington officials last month by E.P. Velikov, the head of the Soviet fusion program, intersected three separate proposals in the U.S. urging the development of fusion and advanced nuclear technologies: the Foster committee report now under consideration by the Department of Energy, Presidential Memo 31 drafted by Ben Huberman of the U.S. National Security Council, and the Rockefeller Foundation report on fast breeder development. (see Washington section, this issue.)

An official U.S. government reaction to the astonishing proposal has not been forthcoming, but in the past two weeks both Energy Secretary James Schlesinger and Undersecretary

John O'Leary have privately been proposing cuts, not expansion, of the fusion budget. Further, well-informed sources report ongoing sabotage within the department of discussions with both the Soviets and the Japanese.

At this writing, only two U.S. newspapers have urged the U.S. to accept the Japanese proposal—*New Solidarity*, the newspaper of the U.S. Labor Party, and *Newsday* published on Long Island. *Newsday* headlined its May 11 editorial on Fukuda, "An Energy Offer We Shouldn't Refuse."

Excerpts from the Fukuda speech appear below.



Fukuda with Carter: An offer he shouldn't refuse.

## The Fukuda Speech

Japan and the United States conducted the series of economic consultations which began last fall and resulted in the Joint Statement of Minister Ushiba [Japan's Finance Minister Nobuhiko Ushiba] and Ambassador Strauss [Carter's Special Trade Negotiator Robert Strauss] last January. The results were gratifying in that both countries, in a spirit of cooperation, reaffirmed our joint commitment to work together, each from its own position, for stabilization of the world economy.

It is important to note that the Ushiba-Strauss statement was based on the concept that these problems can be resolved, not through protectionism and the contraction of world trade, but through liberalism and world trade expansion.

Our target of 7 percent real growth this year is far higher than the growth target of any other developed economy. The Bank of Japan has reduced the discount rate to 3.5 percent to help stimulate domestic demand, and we are endeavoring to expand imports by slashing tariffs, liberalizing quota controls, expanding quotas on a num-

ber of products, liberalizing foreign exchange controls, expanding import financing, and related measures.

The world economy is in the doldrums. The developing countries are suffering particularly severely. Never before has there been such urgent need to strengthen international cooperative efforts to resolve the economic difficulties facing the developing nations, and to promote their economic and social development. Both Japan and the United States, individually and in concert, must play increasingly important roles in this enterprise.

### Technological Development Key

From this perspective, I should like to explore with you briefly the area of science and technology as a most promising opportunity for cooperation between Japan and the United States.

Modern science and technology, as our generations know very well, can either contribute immeasurably to human comfort and convenience, or can be the servant of war and destruction. Science can provide impetus to new productive activities, and serve as a



prime mover in the future expansion of the world economy, or can waste our resources and threaten our survival.

Exactly because of this dual character of science and technology, I believe it is the duty of Japan, a nation dedicated to peace, to participate vigorously in cooperative international efforts to utilize science and technology solely for improving the standard of living of the world's peoples.

In the course of my discussions with President Carter, I made some specific proposals for scientific and technological cooperation.

Japanese-American cooperation is most urgently required in pursuit of the technical feasibility of developing nuclear energy for peaceful purposes, without the risks of proliferation of nuclear weapons. The importance of peaceful nuclear energy cannot be overemphasized, especially for a country such as Japan, which has no significant energy resources of its own, and ranks second only to the United States as an importer of oil.

#### Nuclear Cooperation

When we consider the peaceful uses of nuclear energy, to secure safety is the indispensable prerequisite. Especially, as we realize that both Japan and the United States use the same type of nuclear power reactors, for Japan and the United States to cooperate together in the research for nuclear safety, so as to improve the safety and reliability of nuclear reactors, will indeed serve the common interest of both peoples.

From a longer-range point of view, the development of new alternative sources of energy invites expanded Japanese-American cooperation. Since world oil reserves are expected to come close to depletion at the end of this century, both our countries should strengthen our cooperative efforts for energy conservation and the development of new energy sources.

I should like to suggest nuclear fusion and solar energy as particularly useful areas for joint R & D, since both are considered to be ultimate energy sources for the future.

Fusion involves harnessing almost unlimited energy from a man-made

process which employs the same principle by which the sun creates its heat and light in nature. It is, in effect, the creation of a miniature sun on earth. Japanese and American experts are already exchanging technical information in this field, but I should like us to take a step further, pooling our human and financial resources in a joint effort to realize an ultimate dream of mankind.

Colossal investments in human and material resources are needed for research and development in all these areas. With a view to making more efficient use of limited resources available, and to make Japan-U.S. cooperation more meaningful, I wish to propose that Japan and the United

States seriously study the establishment of a joint fund for the advancement of science and technology, to serve as a framework for international cooperation in these areas. I hope to pursue this idea with our American colleagues concerned, and I trust you and your countrymen will be responsive to my proposal.

Needless to say, there is no reason to limit such partnership in scientific and technological cooperation to Japan and the United States alone. The door could be open for participation in these projects by all countries which wish to cooperate with Japan and the United States to put science and technology to work for the well-being of mankind.

## U.S. Must Face the Future

*Tsutomu Kawara, a member of the House Representatives of the Japanese Diet who accompanied Prime Minister Fukuda on his recent five-day visit to the U.S., provided some of the background to the Fukuda offer in a recent interview with the Executive Intelligence Review. Kawara is a leader of the Study Group on the Future Energy Sources of the ruling Liberal Democratic Party. Excerpts from the Kawara interview follow:*

...The first goal of the year [fiscal year 1978] is the domestic recovery of the Japanese economy. The second goal, however, is to help the world emerge from the global depression. We are determined to cooperate with the Less Developed Countries in this effort.... We like the idea of trilateral cooperation with the developing countries, involving the United States, Japan, and maybe West Germany....

As you know, much research is already taking place on the development of alternative energy sources and cooperation between Japan and the U.S. in this regard already exists. But this can be expanded.

Last summer, I came to the U.S. with a group of other members of the

Diet, and we traveled around the United States exchanging ideas on alternative energy sources. We spoke with General Electric, General Atomic about research and development efforts; we traveled to Houston and talked with oil producers; we came to New York and talked with executives from the major oil producers....

In Japan, 31 congressmen, including myself, have formed a group to study future energy sources. We particularly like nuclear fusion.

I believe that mankind must continue to develop and grow, and the industrialized countries can greatly benefit, both materially and culturally from the development of fusion power. Prime Minister Fukuda supports this project....

Before I came to the U.S., I saw the American movie "Close Encounters" (a popular science fiction about the technology of the future), and I think that the U.S. must have an encounter with the future. The U.S. must face the future with courage. If this is done, the dollar will regain its international prestige as the key international currency. In this regard, I think Japan and the U.S. should cooperate very closely in developing the technologies of the future for the benefit of both countries.

# Brezhnev-Schmidt Treaty: Peace, Prosperity, Progress

West German Chancellor Helmut Schmidt and Soviet President Leonid Brezhnev signed the biggest economic deal of the century in Bonn, West Germany May 6. The treaty frames cooperation on a level that amounts to near-integration of the two economies, provides for strategic agreements, and opens a new range of possibilities for scientific and technological research and innovation.

During the Brezhnev-Schmidt meetings that led to the treaty and communique, the Soviet president for the first time presented the perspective that the way to avoid war is by expanding economic cooperation.

The communique reads in part:

Both sides set themselves the goal of promoting scientific, industrial, and technological cooperation. They consider such cooperation to be an important and necessary element for strengthening their bilateral relations.

This cooperation should be increasingly oriented to the long term, so that mutual interest in its development grows. Thus emerges a solidly developed material fundament of mutual relations which extends beyond this century and is to the advantage of the peoples of both countries.

Schmidt's speech at a breakfast meeting with Brezhnev the day the treaty was signed pointed up the international meaning of the agreement. "I am not particularly thinking of joint efforts with the aim of not allowing any further widening of the gap between the developed industrial countries and the developing countries. . . . On the contrary, we must overcome the gap," the chancellor said.

"This is just the kind of arrangement the FEF proposed in its document on the SALT negotiations, *From Detente to Entente*, FEF director Morris Levitt

commented. "The treaty has already demonstrated that far-reaching political and economic arrangements can transform the context of strategic questions. For example, the Soviets agreed to reopen the question of the levels of deployment of SS 20 missiles."

"Should the U.S. enter into comparable arrangements, and begin vast joint efforts in fusion and space research," Levitt said, "the face of the planet would be rapidly transformed."

The text of the treaty is available from *Campaigner Publications*, Box 1920, GPO, NYC 10001 for \$1.50.

## Pugwash Call For Fusion Cooperation

The Pugwash conference in Poland April 16, issued a call by 30 scientists from the U.S., Soviet Union, Western Europe, and the developing sector for cooperation on "important research problems which individual states could not tackle by themselves." The Pugwash group included in their call joint thermonuclear fusion centers in Eastern and Western countries and expanded joint work between the East and West in studying various forms of energy.

Soviet scientists have suggested that the pro-fusion Pugwash statement may have been the result of the attendance at the conference by Academician E.P. Velikhov, vice president of the Soviet Academy of Science and a primary spokesman for the Soviet fusion program. It is also likely that the informal proposals Velikhov made during his trip to the U.S. in April will be formalized during the joint U.S.-Soviet fusion committee in early May in Moscow.

The Pugwash conference is an annual meeting of East-West scientists to discuss collaborative efforts in various areas.

Are you  
depending  
on the  
grapevine  
for the  
day-to-day  
information



you need for decisions

...and getting  
a lemon?

Don't die on the vine. Get the facts and analysis you need to make those important decisions. The *Executive Intelligence Review* has reporters where you need them. We cover stories others don't dare touch.

You can't afford not to read the

---

## EXECUTIVE INTELLIGENCE REVIEW

---

Isn't it time  
you subscribed?

Single issue: \$10  
SUBSCRIPTIONS—  
3 months: \$125; 6 months: \$225;  
1 year: \$400

For more information, contact

New Solidarity Int'l. Press Service  
GPO Box 1922  
New York, N.Y. 10001  
(212) 563-8606

Advertisement

## Washington

# Energy Dept. Spurns World Fusion Effort

The response of the U.S. Department of Energy to Japanese Prime Minister Takeo Fukuda's offer of joint \$1 billion fusion research program has been to threaten more cuts in the already limping U.S. fusion program.

Sources within the department's magnetic confinement program report that Energy Secretary James Schlesinger and Assistant Secretary John F. O'Leary told their division that the fusion program will have to take a \$20 to \$30 million cut in order for \$100

million to be added to the 1979 fiscal year department funding for solar energy.

"Fusion is too far off and can't solve our more immediate energy problems," O'Leary said. He is contending that \$100 million must be cut from the 1980 fiscal year fusion budget—a cut that would make U.S. participation in a world fusion program impossible.

According to Washington sources, however, the Schlesinger-O'Leary

reaction won't wash with Congress. Staff members of the House Science and Technology Committee, which last month restored all the cuts in the fusion program requested by Schlesinger, have called the O'Leary solar proposal "pure bluff." Even within the Department of Energy, there is little belief that Congress would agree to program more money for solar energy into the 1979 budget at the expense of fusion.

In addition to the Japanese fusion offer, department officials have before them the equally extraordinary offer of E.P. Velikhov, vice president of the Soviet Academy of Sciences and head of Soviet fusion research. Velikhov privately proposed to U.S. officials in March the joint development of a prototype fusion power reactor.

The current \$330 million U.S. budget for fusion research by the department's own admission is not enough to ensure the U.S. development of commercial fusion reactors in this century.

## Carter OK's Uranium for India

President Carter overrode the decision of the Nuclear Regulatory Commission and approved the sale of 7.6 tons of enriched uranium fuel to India April 27. In a letter of explanation to Congress, Carter said rejection of the sale would undermine the efforts of the U.S. to influence India to enact nuclear safeguards and that "the denial of this export would seriously prejudice the achievement of other U.S. nonproliferation goals."

Reports from New Delhi are that the Carter decision met a cool reception. The Tarapur nuclear reactor, which supplies the Bombay industrial area with power, requires between 18 and 22 tons of fuel annually. The shipment Carter approved would last only until the end of 1978. The plant has been operating at 60 percent capacity because of limited fuel.

The two-to-two split decision of the four-man commission was the first time in its three-year history that it had failed to authorize a uranium shipment. The two commissioners who favored authorization released a statement charging that the commission was trying to "usurp the roles of the White House and the National Security Council in attempting to shape foreign policy."

Congress has 60 days in which it can override the executive order, but there appears to be little congressional interest in doing so.

India is the Third World's most developed nuclear power, and its Department of Atomic Energy employs 10,000 atomic scientists and engineers.

## DOE Experts Group Recommends More Funding for Fusion Research

The Ad Hoc Experts Group on Fusion, appointed by the Department of Energy in October 1977 to assess the current U.S. fusion program, has recommended a full-speed-ahead approach to developing fusion power. The group, known as the Foster Committee, issued a draft report to the department on the magnetic and inertial fusion programs in mid-April, but the report has not yet been made public. Dr. John Foster, vice president of the TRW nuclear corporation, chairs the group.

According to knowledgeable sources, the Foster committee has stated that fusion is one of the only possible sources of future energy and that therefore it is urgent to determine its practicality as soon as possible. This means, the Foster Committee said, significantly increasing research and engineering funding from its present level which is not even keeping up with inflation. The committee also recommended an expansion in the number of power reactor designs.



Aerial view of the site of the Clinch River fast breeder reactor in Oak Ridge, Tennessee. ERDA

## Rockefeller Report Urges U.S. to Go With Fast Breeder

The Rockefeller Foundation issued a report in mid-May sharply criticizing the Carter administration's breeder policy and urging the U.S. to "take steps to move back into a position of technological leadership on the breeder reactor."

The report, "International Cooperation on Breeder Reactors," demolishes the administration's argument that development of the Clinch River fast breeder will aid in the proliferation of nuclear weapons, and it urges the U.S. to join with Japan for a breeder demonstration program that can be rapidly commercialized.

The study was prepared under the direction of Dr. Mason Willrich, a former official of the U.S. Arms Control and Disarmament Agency, and other leading international nuclear experts. Its outspoken advocacy of capital-intensive energy growth makes it a highly factional document in the ongoing fight for international cooperation for high technology energy development.

### Clinch River Stalled

The Rockefeller report should be a shot in the arm for the probreeder faction on Capitol Hill. As of this writing, funding for the Clinch River nuclear fast breeder project is stalled in the Senate with no immediate action expected on the 1979 fiscal year budget. Pronuclear Washington sources have said that the pivotal legislator who must be pressured is Senator Frank Church, an Idaho Democrat who plans to propose a compromise bill, similar to the Schlesinger plan voted down by the House Science and Technology Committee April 12. That compromise would have eliminated construction of Clinch River in favor of a 30-month study of alternatives. Instead the House committee added \$140 million to keep the Clinch River project alive.

## Will Industry Fight Schlesinger's Nuclear Licensing Bill?

The House Interior Committee will begin hearings May 15 on the Nuclear Licensing and Siting Bill, submitted over a month ago by Energy Secretary James Schlesinger. Although the bill has been promoted by Schlesinger as a means to cut nuclear power plant licensing time from 12 to 6 years, the actual effect of the bill could be to close off the nuclear path completely. In its current form, the legislation would fund environmentalist "intervenor," permit conservation to be considered as an energy alternative, give veto power to states and possibly localities over siting and construction decisions, and allow an undefined concept called "need" (instead of "demand") as part of the determination process.

The utilities and nuclear industries are now split over whether to launch a full-scale offensive against the bill or to accept the "bad" parts with the hope that licensing and construction time can possibly be cut down. The Washington-based American Nuclear Energy Council, the lobbying arm of

the nuclear and related industries, has decided to try what they describe as an end-run around the bill's most heinous provisions. The council will fight the states' rights issue in the bill by challenging the constitutionality of state industrial pollution standards that override federal policy. The council reasons that if this battle is successful, it will apply as well to the nuclear siting question.

The Schlesinger bill faces other problems, in addition to potential industrial opposition. Staff members on various House committees have reported that the bill has "no constituency"—not even among the environmentalists. At this point, one staffer said, most of Congress "would not trust anything submitted by Schlesinger." It is predicted that the bill will not be voted up in this calendar year.

The Fusion Energy Foundation is opposing the bill on the basic constitutional issue of the right for the nation to have a *growth-oriented* national energy policy.

If you need  
energy news  
at your  
fingertips. . .

And oil or  
coal reports  
are not enough,  
read the

### Daily Energy Intelligence Bulletin

Produced by the Executive Intelligence Review, the bulletin provides all the latest news about energy politics, scientific breakthroughs, the ecologists' latest ploys, the energy lineup on Capitol Hill, energy deals worldwide — in short form, five days a week.

\$2,000 per year sent airmail or first class; telex and express mail at additional cost.

For more information:

Executive Intelligence Review  
Daily Energy Intelligence Bulletin  
GPO Box 1922  
New York, N.Y. 10001  
(212) 563-8606

Advertisement

## NSC Staff Member Calls for Fusion

In a March 24 memo on technology transfer, U.S. National Security Council staff member Dr. Ben Huberman called for increased cooperation with the Soviets in the energy area, specifically fusion research. The Huberman memo was later drafted into a Presidential Review Memorandum, PRM 31.

Published in the May 6 issue of *Human Events* magazine, the memo indicates that the ongoing factionalizing in the Department of Energy around the question of advanced technology and zero-growth reaches into the highest Administration levels.

The Huberman memo states that "controls on exports of technology to communist states are not central to U.S. security, economic, or political interests. . . . The U.S.-USSR strategic balance is only marginally influenced by export controls. . . ."

"East-West cooperation in energy as in other economic areas may enhance relations and reduce tensions. . . . The prospects for mutual benefits are promising, specifically in the fusion and magnetohydrodynamics projects. . . ."

## Sen. McClure: No Compromises With Antinuclear Forces

U.S. Senator James McClure told a meeting of the Atomic Industrial Forum May 10 in Washington that pronuclear forces must make "no more compromises" with antinuclear forces. The Idaho senator, a staunch advocate of the Clinch River fast breeder and an opponent of the Carter administration nuclear nonproliferation policy, told his industrial audience: "You cannot win this battle by conceding any moral position to your opponent. . . . The supporters of nuclear energy must realize that

nuclear energy is a moral necessity."

Citing the recent policy statement of the National Association for the Advancement of Colored People, which calls for expanded development of nuclear energy and oil and gas, McClure told the group "We must build on new alliances" to build support for nuclear energy.

## Nuclear Scientists Brief Congress

Professor Bernard Cohen from the University of Pittsburgh and Dr. Walton Rodger, a nuclear consultant, briefed over 60 congressional staff members on the "misconceptions, magnifications, and myths" of radioactive wastes April 27. Cohen, a nationally recognized expert in nuclear physics, compared the waste problems associated with coal-burning power plants to nuclear plants. In addition to the tons of gaseous and solid by-products of coal-burning plants, he said, these plants emit more than 40 proven carcinogenic chemicals. By comparison, a similarly sized 1,000 MW nuclear plant produces 2 cubic yards of waste in one year—small enough to fit under a dining room table.

As for the concern that buried reprocessed waste containers could "leak" dangerous materials, Cohen demonstrated that it would take 1,000 years for the ground water containing such radioactive waste products to get to the surface. It would take additional millions of years for the actual nuclear materials to drain to the surface, he said.

Both speakers stressed that using uranium reserves, would "cleanse the earth of existing natural radioactivity" and actually save about 50 lives per year—the number of persons killed after contact with uranium deposits. In response to a staff question about the assumption that nuclear spent fuel would be reprocessed, thereby producing a less toxic waste, Cohen replied that he assumed the U.S. would "recover from this current insanity" and not bury spent fuel, but realize its value as an energy source.

## National

# Sun Day Sets —But Carter Goes Solar

The nationwide Sun Day event May 3 failed to turn out the crowds hoped for by sponsors of the multimillion dollar event and failed to create any antinuclear violence. Yet despite the evident lack of mass support for the antitechnology celebration, the Carter administration and the hard-core zero-growthers are using Sun Day to create a case for dumping nuclear power and fusion research in favor of soft technology solar alternatives.

Carter began the solar push on Sun Day by appointing Energy Secretary James Schlesinger to head up a cabinet-level domestic policy review committee of all federal agencies to develop increased support for solar energy: "The job of the committee will be to develop a national solar strategy. I have asked the Department of Energy through reprogramming [of the fiscal year 1979 budget] to provide an added \$100 million for solar research and... windmills in the next year," the president said.

### Sun Day Terrorists

The press has helped make up for Sun Day's lack of mass support with an extraordinary volume of fairy tales about clean solar energy. But if the lack of scientific credibility to the solar stories did put off most Americans, seeing the solar advocates first hand surely did. "The Sun Day organizers are the same people who sold me LSD in the 1960s," was how one angry caller characterized the solar crowd to a Philadelphia radio talk show featuring John Schoonover of the Fusion Energy Foundation.

Although the solar propaganda has proliferated, none of the planned



Photo by Ulanovsky

*Sun Day at the United Nations: An environmentalist zombie decorticates a teddy bear in sacrifice to the sun.*

antinuclear events has managed to create the atmosphere of terror and violence that the Sun Day organizers, including Energy Secretary Schlesinger, had warned was inevitable. "Terror is unappetizing, but you can't do anything until after it happens," Schlesinger told a reporter April 14 at a speech in Princeton, N.J.

The Sun Day mass demonstration against the Rocky Flats, Colorado nuclear weapons facility, pulled in only 2,000 environmentalists instead of the thousands expected. As a finale to their dispirited rally, 27 were arrested after a sit-in on the railroad tracks leading to the Rocky Flats facility.

Another antinuclear action at the Barnwell, South Carolina reprocessing site was billed as a "human petition" against nuclear power, but it reached a grand total of 250 protesters who were shipped into the site from as far away as New England.

"The fact that solar power is 10 times more costly than nuclear power and that it is labor intensive—employing manual labor at low wages—makes it clear that the solar organizers do not have the national interest in mind," a Fusion Energy Foundation spokesman commented on Sun Day. "The solar fanfare is an excuse for a wrecking operation against the fusion research budget and for continuing the deindustrialization of the U.S. We challenge the Sun Day champions—Sen. Ted Kennedy, Sen. Charles Percy, Representative Richard Ottinger, California Governor Jerry Brown, William Winpisinger, head of the International Association of Machinists and Douglas Fraser, President of the United Auto Workers union, among others—to prove that their solar proposals will improve the national economy and create better living standards here."

## Younger Hits States' Rights on Nuke Question

California Attorney General Evelle Younger's widely publicized legal opinion calling the state's restrictive nuclear statutes unconstitutional has given new hope for the stalled Sun-desert nuclear plant in southern California.

Younger's opinion April 24 came after the state assembly's refusal to give the plant an exemption from the antinuclear statutes, known as the nuclear bills. The 1976 bills forbid the construction of any nuclear power plants in California until the federal government introduces a national system of nuclear fuel reprocessing and waste disposal.

The nuclear bills are a preview of what U.S. Energy Secretary James Schlesinger intends as the effect of the Nuclear Licensing and Siting Act he submitted to Congress. The act would cede to the states the power to review their own environmental and power needs and to legislate accordingly.

### No to States' Rights

Younger stated that the federal supremacy clause of the U.S. Constitution and the Atomic Energy Act of 1954 make it clear that the federal government has jurisdiction over the construction and operation of nuclear reactors and over radiological hazards. Although a 1959 amendment to the Atomic Energy Act permits the Nuclear Regulatory Commission to cede some of its supervisory power to the states by specific agreement, the commission cannot give away authority over nuclear construction or radiation hazards. Federal authority, said Younger, is absolute; no dual jurisdiction can exist. Therefore, the California nuclear bills are unconstitutional, he said.

Younger urged anyone to start a suit challenging the statutes and announced that as long as the statutes remain in effect, his office will refuse to act as counsel for the State Energy Commission in any legal actions brought against it.

If quick action is not taken, "the light will go out in California," Younger said. He estimated that two to three years at most remained before the obstructionism of the environmentalists causes an economic collapse of the state.

The Southern California Edison Company has contracted lawyers to study the Younger opinion and the April 3 U.S. Supreme Court's ruling in

favor of Vermont Yankee-Consumers Power Company nuclear plants, and will make a decision on a suit against the nuclear bills within a month.

In addition, State Representative William Dannemeyer announced that he will resubmit the exemption bill to the state assembly, although California's Governor Jerry Brown, a solar champion, has promised to veto any exemption. If the nuclear statutes are found unconstitutional no exemption will be necessary.

Despite Brown's zero-growth campaign, California voters roundly defeated an antinuclear referendum in November 1976.

— D. Goldberg

## TVA Commissioner Resigns

The unexpected resignation in May of William L. Jenkins, one of three directors of the Tennessee Valley Authority, has opened the nation's largest electric power utility to the possibility of a takeover by zero-growth advocates.

A Nixon appointee whose term was to expire in 1981, Jenkins quit in disgust at the Carter Administration's environmentalist prejudices, especially the vigorous governmental defense of the three-inch snail darter against the power and irrigation needs of the region. In his resignation statement, Jenkins called the Environmental Protection Agency "out of touch with reality and the average, ordinary citizens."

Jenkins's resignation followed by one month that of TVA General Manager, Lynn Seeber, for the same reasons. In addition to the resignations, Aubrey Wagner, the TVA chairman under whose 17-year tenure as commissioner the TVA became the center of the nation's nuclear power development, retired in May.

Left as the only remaining commissioner on the TVA board is S. David Freeman, a 1977 Carter appointee and a Ford Foundation protege. An anti-nuclear spokesman who had helped draft the no-energy program proposed by Energy Secretary Schlesinger, Freeman recently stated that he wants "to

hook TVA customers to the sun." Freeman had split with Wagner and Jenkins openly in the case of the snail darter, a fish species allegedly endangered by construction of the TVA's Telleco Dam power project.

The central issue now is who Carter will name to fill the two TVA vacancies. Already mooted is the name of Frank Gibbons, director of the Environment Center of the University of Tennessee.

At stake is the future of the nation's largest electric utility, covering a seven-state area in the Tennessee Valley. Under Commissioner Wagner's term, the TVA has transformed the 80,000 square mile region into a growing development area, reversing earlier outmigration by providing cheap abundant electric power to industry.

—William Engdahl

Advertisement

### FEF POLICY STATEMENT ON CLINCH RIVER UPGRADE CLINCH RIVER!

Order from:  
Fusion Energy Foundation  
P.O. Box 1943  
GPO New York, NY 10001

\$1

## Conferences

# Detroit: The U.S. Must Go Nuclear

The 200 participants at the Fusion Energy Foundation's Detroit conference May 9 responded to the announcement of the multibillion dollar Soviet-West German trade deal with a unanimous resolution to write the U.S. into these historic economic development accords. "The United States must make nuclear power the backbone of our energy policy and our renewed economic development," the conference resolution stated. (See box for full text.)

The conference, "Energy and Jobs in an Expanding Economy," drew representatives from Consumers Power Corporation, Michigan Consolidated Gas, Gilbert Commonwealth, the Michigan Farm Bureau, the Department of Agriculture, the Cincinnati chapter of the National Association for the Advancement of Colored People, several labor unions, and colleges, and the U.S. Labor Party.

In the first of three panel presentations, G.B. Falls, president of the

NucleDyne Corporation joined FEF nuclear engineer Jon Gilbertson and Labor Party executive committee member Carol White in a panel discussion of energy and the economy.

### Energy Development

A former advisor to the International Atomic Energy Agency and an engineer for 27 years, Falls told the audience:

"My interest is to promote what the Labor Party, NAACP, and many other organizations in this country are pushing for—an energy development policy. I've done studies in 111 countries...We're going down the drain if we don't promote the increase of energy."

"The American people want nuclear power," Falls said. "Our commitment to technology is our greatest asset and our best deterrent to war." He then developed the concept of the direct correlation between energy consumption and gross national product,

democracy, and the standard of living. "Security is energy density," he said.

Falls demanded the immediate practical application of nuclear energy. "I throw out a challenge to local utilities.... I suggest that Detroit Edison build the latest model nuclear power plant on the salt mines in the vicinity of the River Rouge Ford Plant, both as a model for producing nuclear energy, and as a model for producing nuclear energy, and as a model for producing energy in an urban environment.... I propose that a good deal of the 'wasted heat' could be used to produce steam to run River Rouge."

Next, Carol White located the energy development outlined by Falls as an essential task of political organizing. Referencing the historic Brezhnev-Schmidt deal, she then called on those present to use their corporate resources and the media to openly support the fight for progress. "No one is speaking for science," she said. "That is a loss of the American system of morality. An American's gut sense of humanity is the development of human creativity embodied in technological know-how."

Jon Gilbertson rounded off the first panel with a slide show illustrating the concept of energy throughput and the needs of an expanding industrial society.

### Energy and Natural Law

The second panel opened with a presentation by Allen Salisbury, a Labor Party national committee member and the author of a forthcoming book on the Civil War and the American economic system. Salisbury outlined the necessary dirigist state policies, as defined by Alexander Hamilton and Henry Carey, to provide for energy development. Darryl Lankford, from the environmental section of Michigan's Consumers Power Company followed Salisbury with a discussion of the problems of

## Detroit Conference Resolution

The following resolution was adopted unanimously by the second session of the FEF conference.

Be it resolved that:

The "Energy and Jobs in an Expanding Economy" conference held May 9, 1978 at Marygrove College, calls on local, state, and national labor and industry, political and religious organizations to begin a broad-based organizing approach to put the question of a positive nuclear power referendum on the ballot for the November 1978 local, state, and national elections.

Given the recent economic trade agreements that have been made between the Soviet Union, Europe, and the Middle East and Africa, this conference affirms that the United States must make nuclear power the backbone of our energy policy and our renewed economic development. *The United States must not be left out of this massive worldwide economic development now taking place.*

This conference calls specifically on Governor Milliken of Michigan and Governor Rhodes of Ohio, and President Carter to back this mandate and make this issue the energy policy of this nation.

The spirit of this conference should serve as the model for a national consensus on a national energy policy.



regulatory agencies and the development of nuclear energy.

The constitutional issues of the energy battle and the concept of natural law were the subject of the third panelist, Max Dean, the attorney of record for the amicus curiae brief submitted to the Supreme Court by the Labor Party in the Vermont Yankee-Consumers Power Company case. Dean spelled out the constitutional arguments against the environmentalists that the Supreme Court had reaffirmed in its April 3 decision in favor of the two nuclear plants, and he noted their application to other antinuclear activities.

"Article One of the Constitution enumerates the power of the legislature concerning commerce...Schlesinger intends to have Congress divest itself by statute of this constitutionally mandated authority, specifically to stall and prevent the development of nuclear power," Dean said.

He urged public opposition and defeat of Schlesinger's states rights licensing bill, reminding the conference that Schlesinger, as Secretary of Defense, called for arming the forward troops of NATO with nuclear weapons. "This policy was designed precisely to prevent the events announced this morning concerning the trade deal."

#### The Humanist Conception

The amicus brief was a humanist conception based on the philosophy of the Labor Party, Dean said. "In a nutshell, there are laws which are independent of man which are discoverable by man and controllable by him. There's no contradiction between man and his environment. Man is a part of his environment and masters it for purposes of his own development. The method of the brief was to elevate the matter of constitutional principles—this natural law concept embodied as a question of energy development—and it poses the assertion that conservation is unconstitutional and antihuman."

The evening session opened with a detailed presentation on the state of fusion research, particularly laser fusion, by Michael Monsler, acting head of the systems group at Calif-



O.B. Falls speaking at the Detroit conference: "The American people want nuclear power."  
New Solidarity

ornia's Lawrence Livermore Laboratories. The audience, which had been joined by a number of skilled workers from the Detroit area, questioned Monsler intently on fusion breakeven and why the Soviets were ahead of the U.S. in fusion research.

Monsler was visibly moved by the audience's identification with scientific progress and with their presentation to him of a portrait of Benjamin Franklin. In response to a question from Joseph Spinola, a Labor Party member and official representative to the conference from local 299 of the International Brotherhood of Teamsters, Monsler said he would try to

make it possible for nonscientists to tour the Livermore Labs.

The conference concluded with a presentation by FEF executive director Dr. Morris Levitt, who discussed the achievements of the U.S. fusion effort and the differences between the U.S. and Soviet approaches to fusion power. "Laser fusion scientists in this country," Levitt said, "don't understand how the Soviets can achieve breakeven using plasma processes that cannot be computer modeled."

Levitt's remarks at a press conference earlier in the day were covered by the area media.

—Barbara Roberts

# Southern Africa: An Economic Solution to the Colonial Legacy of Apartheid

In a well-attended conference May 2 in Washington, D.C. the Fusion Energy Foundation drew together an international grouping of 100 industry and government representatives, scientists, diplomats, scholars, and students to discuss and debate the industrial development of southern Africa. The conference centered around the critical role of advanced technology—in particular, fusion power—to world development as laid out in the foundation's program for the southern African region.

In his welcoming address, FEF executive director Dr. Morris Levitt struck the theme that was sharply debated during the sessions: "The United States is the model for the development of southern Africa." Levitt cited the recent comment by Andrew Young, the U.S. Ambassador to the United Nations, that the U.S. is still held in high regard in the Third World because of its unparalleled industrial development.

Eric Lerner, director of physics for the FEF, then presented the outlines of a massive development program for the southern Africa region. He contrasted this program, proposed by the foundation, to the attempts of the World Bank to have "regional development" without raising labor productivity.

## Politics and Economics

"The political and economic solutions must go together," Lerner declared. "There will be no solution to the colonial heritage of apartheid without development—only redistribution of the existing poverty and war. On the other hand, there can be no solution to the requirements of economic development unless the skilled labor force is developed. That means an abrupt end to apartheid.

"Contrary to what everyone thinks,

southern Africa's greatest resources are not the vast mineral wealth of the region," Lerner elaborated. "Its basic resources are the pockets of skilled labor, which must be used as centers to upgrade the entire population."

In a complementary presentation, Douglas DeGroot, specialist on Africa for the *Executive Intelligence Review*, posed the question of the political feasibility of implementing such a program in South Africa. "The humanist forces to collaborate on industrial development in the region do exist," DeGroot assured the audience, "but there has been a conscious effort through history to keep them from working together."

DeGroot then described the pro-industrialist tradition of the Kruger Republic of the 19th century and the three centuries of British counter-insurgency against this tendency. DeGroot proposed a Southern Africa Development Association to bring together the still extant proindustrial layers in South Africa with the political elites of Black Africa such as, especially, the politically stable leadership of Angola which is not racially oriented.

## What About the Soviets?

Another crucial aspect of the region's political physiognomy was then discussed by panel member Dr. Peter Vanneman, chairman of the political science department of the University of Arkansas at Fayetteville. Vanneman stated that certain factions within the Soviet leadership would be amenable to a development plan in the region. Because of their own economic problems, Vanneman added, the Soviets are eager to gain access to southern Africa's mineral wealth.

"The Soviet leadership has been deeply divided over Africa policy,

especially since Angola," Vanneman noted. He pointed out the exceptional restraint used by the Soviets in Ethiopia, where Soviet military aid was not sent until months after the Somali invasion. But "If we don't strengthen the hand of the moderates in the Kremlin," Vanneman concluded, "there will be a holocaust." The Soviets are in Africa to stay, he said. "Whether they play a constructive or destructive role" depends mainly on whether or not the United States is pursuing a development policy.

The first panel's deliberations were brought to a close by David Carr of the National Foreign Trade Council, where he is director of the Africa, Mideast and Pacific Division. Dr. Carr, who stressed that he was speaking personally and not for the council, outlined three major stimuli that historically have proven to foster economic development. These are expanded exports, high rates of savings and investment, and structural transformation of the economy (for example, diversification).

## The Question of Education

Addressing the question of how to fuse these three stimuli, Carr reemphasized the education and training aspect of Lerner's earlier presentation. He recalled "the model of an anti-development policy" in the behavior of the Sultan of Oman, who insisted that a major pipeline being built in his country by an oil company should employ the tribesmen of that area each time the pipeline construction crossed tribal boundaries. Since no worker was employed for more than a few miles, this guaranteed that none "acquired permanent skills—and with them dangerous political ideas!"

Carr went on to score South Africa's pursuit of a similar policy in importing labor from neighboring Black African states. Workers come alone and only for a few months. Carr stressed the "key role of developing permanent skills, which can then be transferred to other industries." In an interview following his talk, Dr. Carr said that the minimum stay for a worker with his family in the industrial center should be five years.

The first afternoon session, titled "The Third World into the 21st Century," led off with a challenge to the concept of rapid and massive development in southern Africa which had been the theme of the morning panel. Dr. Stan Krause, a member of the U.S. Department of Agriculture currently on assignment with the Africa Bureau of the U.S. Agency for International Development, described the severe problems posed by the agricultural sector, which engages over 50 percent of the economically active population in the 10 countries of southern Africa.

#### **The Commitment to Humanism**

Pointing with pride to the potential of American contributions in training programs and applied agricultural research ("We wrote the book on that."), Krause nonetheless countered the FEF proposal of concentrated high-technology development pockets with a strategy of "slow incremental growth,"... "limited packages of new technology rather than a quantum leap."

The AID expert cited the history of 54 countries that had received development aid over the past three decades but did not sustain rapid per capita growth. "Crash programs cannot succeed," he concluded.

The next presentation, by FEF director of research Uwe Parpart, met the challenge Krause had raised. "Instead of looking at the failures of the past 30 years," Parpart proposed, "I find it remarkable that no one discussing development has pointed to the two outstanding models of success—the United States and the Soviet Union.

"No successful effort can proceed on short-term expectations," the FEF scientist affirmed. "The results of small increments in a given mode of production proceed inevitably from the very assumptions on which they are based." Instead, the American experience was the outcome of a debate in the 18th century between a commitment to developing labor power through high technology growth, and the contrary premise of labor intensive exploitation of raw materials. "We are talking about two

colonial policies," Parpart said, "the British colonial policy and the humanist one by which an American continent would carry forward the best efforts of Europe.

"The American model is very simple," he continued. "The most educated strata—a thin elite—absorbed the most highly developed industry," while European-born peasant labor, the backward part of the population, was brought in "in successive waves."

"Slow growth is not an alternative to this model," he warned. "It will mean devolution and chaos."

Dr. William van Rensburg then reported to the conference on the extensive mineral wealth of southern Africa and its importance to the world's industrial economies. Van Rensburg, who is chairman of the West Texas University Geoscience Department, noted that contrary to popular illusion, South African minerals are not an easy "bonanza." Most of the vast deposits are in remote areas and are low-grade ores that require the most advanced mining technology to exploit.

#### **The Importance of Fusion**

In introducing the last speaker of this panel, Dr. Levitt noted that precisely this need to access low-grade ores in the future demanded the unlimited energy resources promised by fusion power. Dr. William Ellis, chief of the advanced fusion systems branch of the confinement systems division of the Department of Energy, held the conference attendees in rapt attention as he delivered an illustrated talk on the present state of fusion research. Ellis showed four charts indicating that scientific breakeven for a successful fusion reaction was extremely close in four of the key criteria. Yet, as another chart showed, federal funding for the fusion program has not even grown "linearly" but has leveled off over the past three years to the point that commercial fusion may not be realized.

In his summary, Dr. Ellis zeroed in on the question of obtaining political support for fusion power. National policy has shifted in the direction of short-term solutions and "appro-

prate" technologies, he reported. In the meantime, fusion lacks a powerful motivation—a "patron saint" in the population. Neither industry, the utilities, labor nor even the scientific community has taken up the banner of fusion development. "We have established the scientific data base," Ellis maintained. "We are well on the way in the next few years to achieving breakeven." As a potential means of providing the world with cheap unlimited power for the future, fusion must be given a chance.

#### **"Financing Development"**

The fourth panel, "Financing Development," featured four speakers. David Shapiro of the Maryland House of Delegates, who recently sponsored a memorial bill in that legislature calling for the rechartering of the United States Export-Import Bank with an increased funding base, greeted the meeting with a call for economic growth, revitalization of the port of Baltimore, and nuclear energy development as the keys to reversing the gloomy cycle of recession and inflation that has afflicted his state since 1970.

Shapiro was followed by Warren Hamerman of the U.S. Labor Party Executive, author of a report to Congress proposing Eximbank expansion, Carlos Romero Barrera of the Mexican Foreign Ministry, and Hahmy Maklouf of the Arab League.

Hamerman noted that in many discussions during the day, conference participants had raised the question of feasibility of the proposals. "Is there an alternative to the current economic and financial system? Yes, there is a means to make the financing of Third World development commensurate with real economic needs," Hamerman said.

The basic conception is of long-term low-interest credits—an idea which has variously been voiced by Eximbank head John Moore and former vice president Nelson Rockefeller, and which was developed in 1977 to an advanced stage by the late Jurgen Ponto of West Germany's Dresdner Bank. Ponto had foreseen linking up the vastly un-

derutilized productive capacity of the advanced capitalist countries with the tremendous development needs of southern Africa, Hamerman reported. Trade flows between OECD countries, the Soviet bloc and the developing sector were illustrated in a chart.

The Labor Party leader attacked the "vicious fallacy" of risk embodied in a frequent comment by bankers and others that even should such an ambitious development program prove politically feasible, who would take the risk? "We cannot afford the risk of not going ahead with such programs, because without them the world is headed toward strategic confrontation," he said. He also cited the policies of Alexander Hamilton that successfully established the roots of American industrial development as the key to the debt issue. Only long-term credits of 20 or more years can achieve real infrastructure, he stated. The best example of the effects of the opposite policy, pursued by the International Monetary Fund and the World Bank, is the decay of New York City after years of short-term high-interest financing.

#### The Debt Trap

Carlos Romero Barrera delivered his speech in Spanish and it was simultaneously translated. "I understand development to mean not only the simple growth and expansion of a country's productive apparatus," he said. "But rather it must be a growth and expansion that results in an increase in national and per capita income, as well as a rise in the level of employment of both human and natural resources of a given country."

Using these criteria, Romero reviewed the sources of external financing for development under the headings of aid, direct foreign investment, and credit through private, public and intergovernmental institutions. He scored the use of aid for servicing of debt or building up the military, but indicated it could be an instrument of real development when "it is regionally invested in the expression and differentiation of the productive apparatus—with resulting effects on the levels of employment and income."

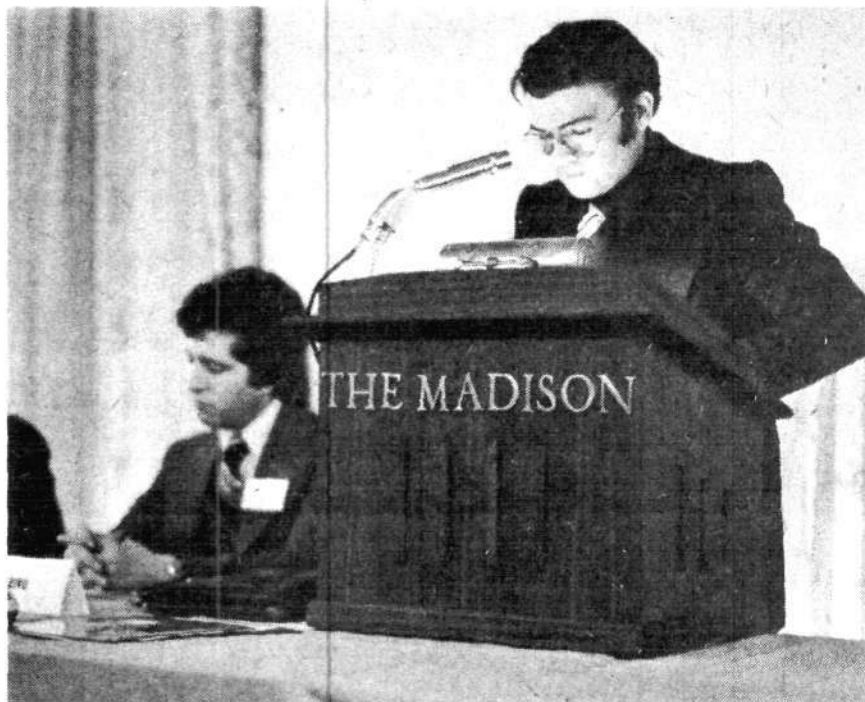

Mexican representative Carlos Romero Barrera: "Development is not just simple growth."  
New Solidarity

Similarly, direct foreign investment makes an effective contribution when it complements rather than replaces a country's own development efforts and when "the national economic profit is greater than that obtained by the investor." Foreign financing, Romero continued, alluding particularly to the IMF, "has in many instances been only a means to repay earlier debts or as an instrument of trade policy of the creditor nations.

"In practical implementation of these ideas," Romero concluded, the Mexican government is using its oil wealth to carry out industrialization in the capital goods sector and also to develop "new sources of energy such as nuclear energy."

In the final presentation, Hahmy Maklouf laid out the Arab League's role both as a group of developing countries and as donors of aid in the past five years to other countries for development. In 1973-77, he said, the Arab oil producing states provided \$19 billion in soft loans and grants to less developed countries among the institutions which channel these funds including the Arab Bank for Economic Development in Africa and the special Fund for African Assist-

ance. Maklouf stressed that the development loans were at interest rates of only 3 percent and had a 15- to 20-year period of repayment. Also strikingly in line with the programs laid out earlier by Hamerman, Maklouf said that the Arab states saw the responsibility for funding development as a global one to be shared among the Arabs, advanced capitalist sector, and the Eastern European bloc.

#### The Participants

Conference participants included representatives of the governments of France, the Soviet Union, Malawi, Lesotho, the Republic of South Africa, South Korea, Mexico, Argentina, Gabon, and Benin. From the United States government were representatives of the Departments of State, Agriculture, Energy, and the Agency for International Development, and the Bureau of Mines in the Interior Department.

Excerpted transcripts of the conference will be available in a few weeks and can be ordered for \$40 from the Fusion Energy Foundation.

—Nora Hamerman

# Music Is The Science Of the Mind

A fusion-based economy requires an advanced musical culture, not rock music's deliberate appeal to the lower animal instincts, Dr. Peter Wyer told the 80 musicians, musicologists, students, and scientists at the April 29 conference on musical science sponsored by the Humanist Academy. Wyer, a collaborator of the Fusion Energy Foundation, heads the academy's musicological research staff, and his presentation led off the day-long conference held at Columbia University in New York.

Wyer illustrated the degradation of rock culture by describing the evidence he sees daily as a physician in a New York ghetto hospital of the moral and neurological decay caused by the ghetto resident's continuous immersion in rock music. Rock is the leading edge of the popular culture's assault on the cognitive powers of the population, Wyer said. "Our task is, therefore, to bring music into the realm of intelligible ideas."

Plato's definition of music was "the science of the mind," Wyer said. There is no strict one-to-one correspondence between the specific advances in the field of mathematics and the physical sciences and those of musical theory, composition, and performance, Wyer said. The real connection lies in the commonality of approach, the task of mastering the transfinite with respect to the lawful nature of the specific field of investigation. In the case of music, he said, this is the human mind itself.

## Tempering

Wyer demonstrated this approach through the question of musical temperament. For all great musical scientists through Bach, the task of

tempering the musical scale—that is, violating the laws of the natural scale through small but crucial adjustments—was not a purely pragmatic question, as invariably argued in textbooks today. As the Arab humanist Alfarabi argued in his *Grand Treatise on music*, natural harmony and temperament must deal with the entire array of musical questions, including performance, composition, and the construction of musical instruments.

Bach's final statement of the tempering principle in his *Well-Tempered Clavier*, Wyer said, in fact was the result of a 150-year project, begun by late 16th century Italian musical scientist Giuseppio Zarlino, on the means of rigorously subsuming chromatic alteration (the alteration of a musical half-step) within a universe of diatony.

## The Vibrating String Problem

Dr. Morris Levitt, FEF executive director, then compared the musical and scientific investigations of the "vibrating string problem." Essentially, this is the basic problem of how a string instrument—or a non-mechanical form of energy like heat and light—can be organized into

appropriate sums of infinite discrete modes through which the energy is packaged in discrete quantities.

As a preface to his remarks, Levitt described how recent discussions on musical science had helped him to define those moments of his own scientific investigation that were characterized by leaps of creative reason. Levitt then briefly reviewed the struggle of great scientists from Huygens through Erwin Schroedinger to solve the question of such leaps—or, more accurately, singularities—with respect to continuous physical processes. This fight itself is a nonlinear continuum, Levitt said, intersecting at many points with advanced musical investigations. As an example, he cited the revolutionary work of J.S. Bach and the political-epistemological fight waged by Gottfried Leibniz.

Unlike musical investigation, which reached a high point of achievement in Beethoven's work and then began a long, painful decline, the progress of scientific investigation into the vibrating string problem continued into the 20th century, Levitt said, culminating in Erwin Schroedinger's near success in 1926-27 in solving the unified field problem. However, from then on British empiricism emerged victorious in the form of Niels Bohr and Werner Heisenberg's psychotic "uncertainty principle." This asserts—just as rock music does in another way—that actual knowledge does not exist, universals are impossible, and all that remains is mere statistical correlation, Levitt said.

The remaining sessions were devoted to defining exemplary problems in the three major fields of musical science: musical-contrapuntal theory, performance, and historiography.

The all-important rigor of performance technique was highlighted by the Italian concert pianist Carlo Levi Minzi. Using examples from Mozart and Beethoven compositions, Levi Minzi proved that the technological development of keyboard string instruments, from the clavichord through to the piano, was a concerted effort to create the potential for highly differentiated, multilayered articulations.



Photo by Ulanowsky

Pianist Carlo Levi Minzi during his U.S. tour for the Humanist Academy.

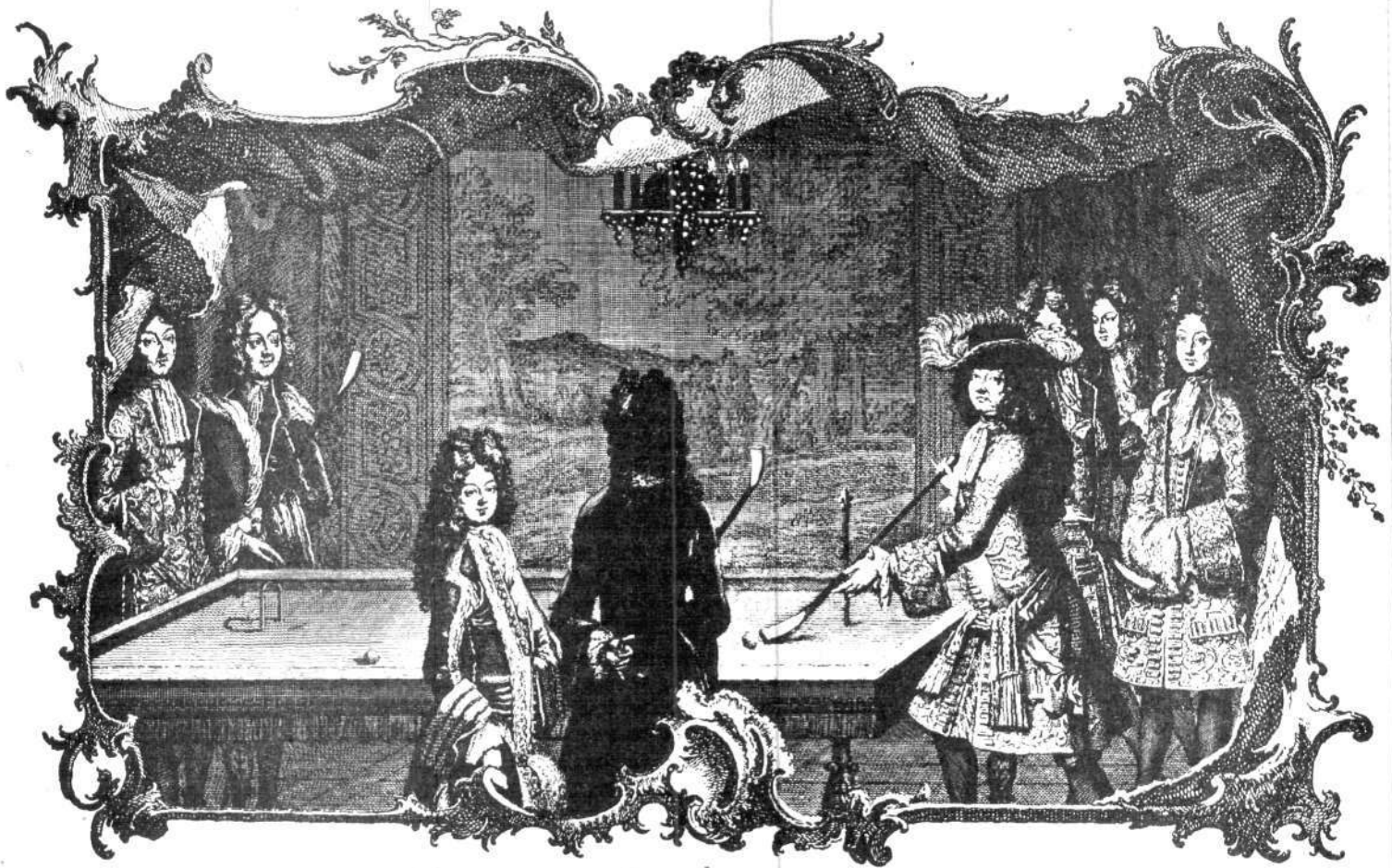

"A rational theory should correctly express not only effects connected with disorganization but also processes of an ordering motion that does not disappear in the course of time, something which constitutes an insoluble problem within the framework of these [present] theories."

—A.A. Vlasov, 1951

# Solving the Three-Body Problem

by Dr. Steven Bardwell

THE MOST PERVASIVE and most serious problem faced by science today is how to account for the global, large-scale order and coherence that characterize the universe when microscopic processes seem to be governed by chance or statistics. As I have shown in a series of articles published by the *Fusion Energy Foundation*,\* the regimes of energy density and the strength of particle interaction in a plasma make it natural to expect that plasma physics should meet this challenge of modern science.

Merely showing that the present understanding of the universe is unsatisfactory is not enough. It is essential to know exactly the breakdown point of the physics and mathematics that have performed successfully for 300 years. Without this more specific critique, there is no basis for distinguishing the different parts of the heterogeneous mixture that is modern physics, nor, more important, is

there a guide to formulating a new understanding. We must be able to show exactly which assumptions in physics lead to the difficulties contemporary physics has in explaining the overriding feature of the universe: the self-ordering, self-developing evolution of all matter.

That the universe is becoming increasingly ordered is strikingly clear from the experience with laboratory plasmas, to take one example. The general tendency is for a hot, dense plasma to proceed from less-ordered to more-ordered states. Intense concentrations of electromagnetic field energy (solitons) form out of nearly uniform fields;

\*"Frontiers of Science in Plasma Physics." *FEF Newsletter*, Vol. 1, No. 6 (June 1976); "The History of the Theory and Observation of Ordered Phenomena in Magnetized Plasma." *FEF Newsletter*, Vol. 2, No. 2 (Sept. 1976); "The Implications of Nonlinearity." *FEF Newsletter*, Vol. 2, No. 2 (March 1977).

filamentlike threads of plasma (vortex filaments) twist out of the uniform plasma; and closed field structures much like smoke rings appear. These experimental results cannot be systematically explained on the basis of present physics, even though this body of knowledge in some instances can describe these results with precision.

The inability of physics to account for self-ordering phenomena in plasmas and elsewhere (most perversely in the case of living systems) can be traced back to the influence of Sir Isaac Newton. Since Newton's time, *reductionism* has been the most thoroughgoing assumption of all physics; namely, the assumption that the universe is a composite of particles and the fields that describe the interaction of these particles.\*

As I will demonstrate using a number of recent results in the theory of mechanics, reductionism cannot provide a coherent account of physical phenomena even on its own terms. For if the world were made up of discrete particles, as Newton has willed, there would be an essential unlawfulness in the universe. Since it is clear from diverse phenomena (such as the pervasiveness of self-ordering) that the universe is lawful, this fundamental assumption of reductionism must be incorrect.

This article concentrates on two new results in the theory of dynamical systems that illuminate the points described above and proves that the assumptions of reductionism must be abandoned. The simplest physical system in which to begin to see the breakdown of a reductionist particle-field theory is the interaction of three of these particles.

It is well known that the two-body system of interaction is completely describable and its integrals of motion have been known since the time of Newton. Reductionism, in fact, is based on the idea of describing complex systems as the combination of two-body interactions. The assumption

### The Three-Body Problem

The most celebrated problem of classical mechanics is how to describe the orbits of three particles that interact by gravity—the so-called *three body problem*. The corresponding problem involving two particles was solved soon after the idea of gravitational attraction was understood, but the effects of the mutual gravitational attraction of three particles remained unsolved.

Two recent results in mathematical physics show that the solution has been so difficult because it actually undermines two fundamental assumptions of classical Newtonian mechanics; namely, (1) that the interaction of a group of particles can be reduced to the sum of the pair interactions or the particles, and (2) that there is a predefined, fixed mode of interaction between these particles. In fact, recent results show that if the two assumptions of Newtonian reductionism were to hold, a lawful universe would be impossible!

is that since singularities (particles) are simple and since the fields of interaction between these particles have a simple continuity, the interaction of three particles will be the summation of their two-body interactions.

Similarly, reductionism deals with the *n*-body problem in terms of the *n*, (*n*-1)-body interactions which themselves are the sum of (*n*-1), (*n*-2)-body interactions, and so on. The content of such an assumption is that the behavior of a collection of matter is only a *sum*, admittedly complicated, of all possible pair interactions (see Figure 1); that is, there are no inherent *many-body, collective effects* that have a qualitative difference from the effects of two-bodies.\*\*

The recent results in the theory of dynamical systems discussed below have implications in two distinct directions. First, they show in a strikingly simple way that the above assumption of reductionism is inconsistent with a lawful universe. Second, these results give a clear indication of the mathematical tools that can deal with the actual evolution of phenomena in both plasmas and living systems.

## Riemannian Geometry Versus Newtonian Particles

The conception of a particle as a point, conserving this property independently of any connection with the medium and other particles, is only an approximate reflection of reality. At the present time, both the experimental facts and the internal difficulties of existing theories make it essential to create a theory based on a new treatment of the concept of the particle.

—A.A. Vlasov, 1951

The simplest test of reductionist assumptions of the reducibility of all physics point particles, is three point masses interacting with a  $1/r$  potential.† This is the classic three-body problem, and its solution has evaded mathematicians and physicists for the past 300 years.

It has been estimated, in fact, that before the year 1900, there were no less than 800 scientific papers prepared dealing with the three-body problem, all trying to determine the motions of three point particles (each of arbitrary mass) that interact through a Newtonian gravitational interaction. As I shall show, the awe with which scientists treated the problem was well deserved; for the modern solution to part of the problem undermines the foundation of the Newtonian physics that posed it!

The first major attacks on the problem and an appreciation of the special difficulty involved were by Euler

and Lagrange, who each published a memorandum on a mathematical simplification of the problem in 1772. (See Figure 3 for a similar technique applied to the simpler case of a pendulum.) Throughout the 1800s, almost every great physicist and mathematician tried his pencil at the problem, with the most spectacular progress made by Henri Poincaré, the French mathematician-scientist. In his three volume treatise, *Les Methodes Nouvelles de la Mecanique Celeste*, Poincaré elaborated a number of new qualitative techniques for devising the appropriate geometry for understanding this problem. However, most physicists agree today that Poincaré's work remains largely unpursued; his most fertile ideas have still to be understood.

At a critical point in his work on the three-body problem, Poincaré summarized the difficulty involved in a geometry that included the properties of the three orbits:

One is struck by the complexity of this figure—a figure that I am not even attempting to draw. Nothing can give us a better idea of the complexity of the three-body problem and of all problems in dynamics where there is no holonomic integral and Bohlin's series diverges.

The difficulty of the three-body problem, as Poincaré noted, has two aspects:

(1) Lawful (that is, causal) collisions are impossible for three particles if they are governed by Newtonian dynamics; and

(2) The nonlinearity of interaction of three particles induces a qualitative change in the nature of their supposed fixed, two-by-two interaction.

#### RECENT RESULTS FROM NEAR-COLLISIONS

In the past two years, an important series of papers has appeared that proves the following long-conjectured hypothesis. (1) The three-body problem cannot be solved; and (2) no complete description of possible orbits has been found previously because there are a large number of trajectories in which the three particles come near to colliding and one of them leaves the near-collision with arbitrarily large velocity.

These conjectures were proved simultaneously and independently by R. McGehee in the United States and J. Waldvogel in Switzerland.

McGehee was able to take this result an important step further to characterize all orbits in which the near-colliding particles either approached the collision along a line (all the particles collinear) or left the near-collision collinearly. McGehee's geometrical construction will be discussed in some detail because, in addition to a proof of these conjectures, it gives an idea of the methods that can lead to the construction of an adequate physical theory to overcome the problem of reductionism.

First, let us look at the consequences of the McGehee



Jules Henri Poincaré  
(1845-1912)

\*Modern developments in physics such as quantum field theory and elementary particle theory have not solved any of the fundamental difficulties of classical physics; and, in a certain sense, they have functioned to obscure the epistemological assumptions of physics. The success of these theories in describing a certain body of experimental results is not in question. But that body of experimental results described is not the central one for understanding the universe. All contemporary physics is a projection, so to speak, of the linear and entropic features of a higher-order, self-developing process. The projection corresponds to an important part of the whole, but it is misleading and ultimately wrong to base a global physical theory on that projection.

\*\*The question of three-body interaction (that is, three-point correlation functions and so on) and of nonlocal forces will be taken up in the concluding section. These seem to be formal tools that overcome the above described limitations of current physics. However, one of the conclusions that can be drawn from the examples here is that a methodology sufficient to deal with self-ordering phenomena, for example, must be drawn from a set of mathematical tools much different from these elaborations of reductionism.

†A so-called  $1/r$  potential is the mathematical form of the force due to gravity between two point-masses and also the force between two electric charges. The strength of the interaction between the two particles in both of these cases decreases as the inverse of the distance between the particles (hence the term  $1/r$ , to distinguish this case from interactions that decrease more rapidly).



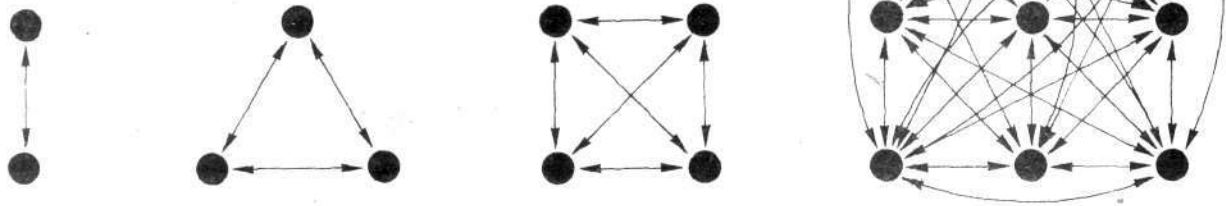

Figure 1  
CURRENT IDEAS OF PARTICLE INTERACTION

The fundamental premise of physics is that particles exist that interact with each other in a fixed way. This diagram shows three cases where each particle interacts with every other, the total interaction being the sum of the two-body pair interactions. The reductionist assumption is that the three-body interaction [which is the simplest many-body interaction] is nothing more than the collection of the various two-body forces possible given three bodies. It is obvious that this problem gets very complicated in the case of more than a few particles [try nine], but the striking new result presented in this article is that the reductionist theory doesn't work even for the case of a three-particle interaction.

and Waldvogel results. If these results described not only the interaction of three point particles interacting by mathematically idealized gravitational forces but also the interaction of actual masses in the universe, what would be the consequences? Such a result would mean that the interaction of three bodies would be entirely unpredictable.

Another way of describing the resulting situation is as follows. Compare the orbits that will result from the near-collision of one set of three masses with the orbits resulting from the near-collision of a different set of identical three masses. The ability to make such a comparison (and prediction) is the essence of lawfulness. McGehee and Waldvogel proved that if three bodies interact as point masses according to Newton's laws, then no matter how similar the before-collision states of each group of three particles, they can have arbitrarily large differences in position or velocity after the near-collision. In other words, the mathematics of the problem are that a perturbation of the initial conditions of the particles; no matter how small, will result in an outcome that differs by arbitrarily large amounts in either configuration or velocity!

The Newtonian physicist might raise two immediate objections to this application of McGehee's result. First, real masses are not point masses; and second, this situation happens so rarely (that is, never, since the orbits with these pathological properties measure zero) that it can be ignored. However, McGehee's geometrical construction of the orbits of three-body collisions provides the response to both of these objections. As will be discussed in detail below, McGehee showed that this pathological behavior occurs for almost all combinations of masses and collinear collisions.

Similarly, Waldvogel states his conclusion as follows: "Thus, after a sufficiently close triple approach, the system may expand to any given size with arbitrarily short time." Notice that since the particles do not actually collide, they do not necessarily have to be mathematical points. However, it is commonly conjectured today that electrons actually are points, and that in this case the full generality of the essential nonpredictability of three-body interactions must be acknowledged.

Put more philosophically, if the above results were to describe the real world, it would mean that sufficient cause would exist for a mass to have any velocity at any time. We on the earth would then be able to observe some local quasilawfulness, but we would be subject to bombardment by objects arriving at the earth without any possibility of our lawfully describing the event.

This classical paradox in philosophy has been used many times to prove the so-called finiteness of the universe. If it were not finite, the proof goes, then the observed lawfulness on the earth would be impossible in principle.\*

The fact is, however, that the universe is lawful; we are not in danger of random bombardment (even if Newton did get hit on the head by an apple). Furthermore, the basic structure of the universe and our continued existence as part of it is evidence of a very thoroughgoing kind of lawfulness.

McGehee's experimental result then presents a striking paradox: The rigorous consequence of a reductionist physical law is the unlawfulness of the universe! To understand the real import of McGehee's result, we must stand it on its head. Since the universe is indeed lawful, then reductionism must be wrong. Since we are not in danger of being hit by flying third bodies, we must conclude that

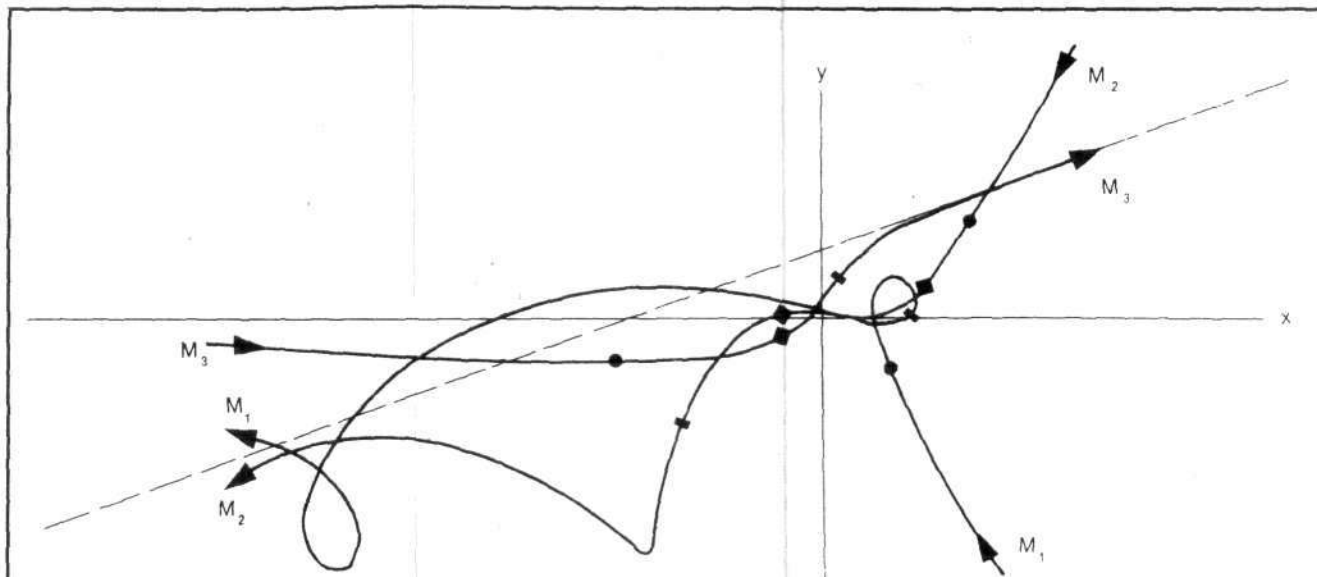

**Figure 2**  
**THE ORBITS OF A NEAR-COLLISION**  
**OF THREE PARTICLES RESTRICTED TO A PLANE**

*This computer-generated solution to Newton's equations shows three particles of equal mass approaching each other along the points of an equilateral triangle.  $M_1$  and  $M_2$  are approaching from the right, and  $M_3$  from the left. This specific collision exhibits a regular feature of three-body collisions: Two of the masses leave the collision orbiting one another [in this case  $M_1$  and  $M_2$ ] and the third escapes with a high velocity. The three particles leave the collision with velocities nearly collinear [the dotted line shows this collinearity] and thus their motion is described by McGehee's analysis. The squares, circles, and rectangles show points on the orbits at equal times.*

*These trajectories are calculated by a computer that solves Newton's equations for three particles. The computer cannot find a single form for the solution for all time, but solves the equations given the initial conditions, and then uses this solution to approximate the solution a short time later. This iterative process is repeated until the above trajectories are found.*

Source: Waldvogel

pairwise interaction of singular particles cannot in principle be the basis of a correct physical description of the world.

#### Natural Geometry

It is necessary to follow the details of the mathematical tools McGehee used in proving the pathological properties of three-body collisions because they indicate the geometric ideas essential to building a new physics.

McGehee constructs a description of the near-collisions of the three-body system with an ingenious use of Riemannian geometry in its broader sense, where the singularities of the geometry determine its global properties. This interdetermination of global and singular aspects of the geometry, in turn, is a model for the structure of actual geometry of the universe and its evolution.

This last point is crucial. The geometry of the universe is structured so that one internally defined (Riemannian) manifold and its laws can be superseded by another, which follows from the first in a lawful way. The transition itself is derived in turn from the singularities in the first manifold (as Cantor's algebra of the transfinite numbers models in the case of arithmetic). A careful discussion of McGehee's work makes this clear.

The complexity of the problem of three-point masses

interacting through a  $1/r$  potential is shown by a computer-generated set of orbits of a near-collision of three point particles (Figure 2). The qualitative result of this collision is characteristic of three-body collisions. The three masses (here equal) approach independently, but two of them leave the collision orbiting each other ( $M_1$  and  $M_2$  in this case) and the third escapes with a high velocity.

Roughly speaking, the third particle gets its large kinetic energy from the decrease in potential energy that results from the close proximity of the other two particles after the near-collision. This is the physical mechanism for the pathological properties of these collisions. Since  $M_1$  and  $M_2$  can get arbitrarily close to one another, an arbitrarily large amount of energy can be transferred from potential energy between  $M_1$  and  $M_2$  to kinetic energy of  $M_3$ .

The orbits in Figure 2 are not very helpful in describing the general features of a three-body near-collision.

\*Boundedness must be distinguished from finiteness here. For causality to exist, the above argument shows that the universe must be finite (if not, then objects can bombard the earth...). But this argument does not eliminate the possibility of an unbounded universe that has the topology of a sphere, to take the simplest case.

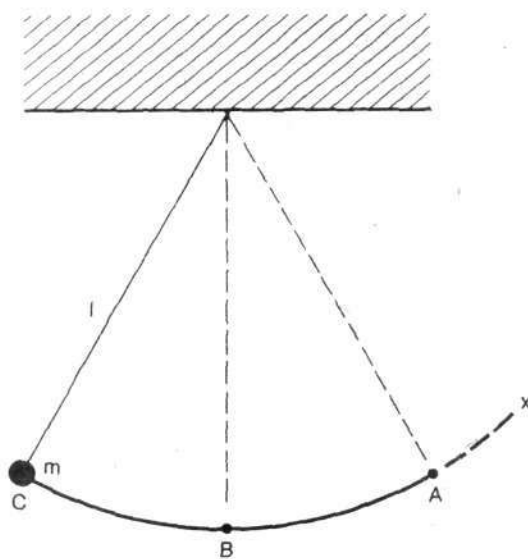

(a)  
THE ORBIT IN PHYSICAL SPACE OF A PENDULUM  
IN A GRAVITATIONAL FIELD

Point A is the point of maximum amplitude and zero velocity. Point B has maximum velocity and zero  $x$ .

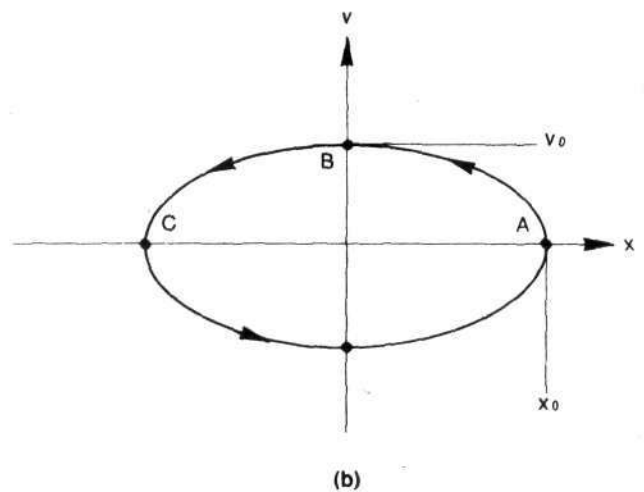

(b)  
THE ORBIT IN PHASE SPACE  
OF THE PENDULUM

The velocity at point B is defined to be  $v_0$ , the maximum velocity, and similarly for  $x_0$  at point A. At point B all the energy of the system is kinetic [ $E = \frac{1}{2}mv_0^2$ ], and at point A all the energy is potential energy [ $E = \frac{1}{2}x_0^2mg/l$ ], where  $m$  is the mass of the pendulum,  $g$  is the gravitational acceleration, and  $l$  is the length of the pendulum. The ellipse is defined by the condition that the sum of the potential energy and the kinetic energy be constant.

Figure 3

## The Four Steps of Abstraction Required for a Conceptualization of Phase Space in the Specific Example of a Pendulum

Diagram [a] shows the physical space [that is, "real space"] trajectory of the swinging pendulum bob. In "sense certainty" geometry, this represents what the pendulum does. Diagram [b] shows the same motion of the pendulum by a single point that describes the pendulum's entire state—its direction, speed, and position—in time. Each point on the graph is determined by measuring the velocity and position of the pendulum as it moves; the orbit of these points over time forms an ellipse, a closed figure because the pendulum constantly repeats the same motion. This is not true in [a] where there is an ambiguity in the diagram about the direction and speed at which the bob moves—these cannot be shown in the simple picture.

The trajectory of the pendulum bob is completely described by the ellipse shown in [b]. However, the essential dynamics of the harmonic motion are still hidden in the complexities of the ellipse; diagram [c] shows the same trajectory in an even more sophisticated phase space, where the trajectory is a circle swept out with constant angular velocity. These simple geometric properties of the orbit occur only for simple harmonic motion; and in this phase space, they are obvious upon inspection of the orbit. As the level of abstraction of the space increases, the dynamics become more and more obvious, because the "real" motion of the pendulum does not occur in the space of [a] but rather in [c]!

The central point about phase space, a concept derived from Riemann, is that the space itself is a dynamically determined structure. This is clearest in diagram [d] where the texture of the space can be seen by looking at the trajectories of all possible motions of this pendulum. They cannot go anywhere they please, but are always restricted to circles, centered at 0, going in the same direction with the same angular velocity.

The reason a pendulum clock works is because it actually functions in the geometry of [d]—not in the livingroom!

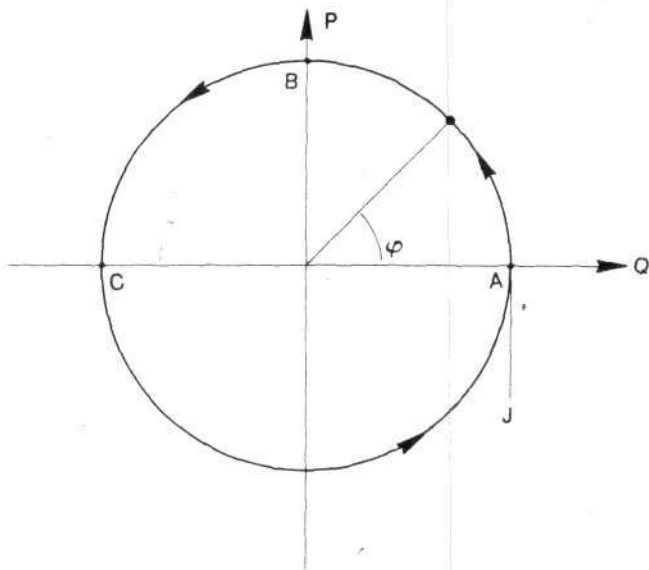

(c)  
A NEW PHASE SPACE AND ORBIT  
BY A CHANGE OF UNITS

By properly scaling  $v$  and  $x$ , the orbit is now a circle on which the orbit is traced with constant angular velocity. The angular velocity is the period of the pendulum, and the radius is the square root of the energy,  $J$ .

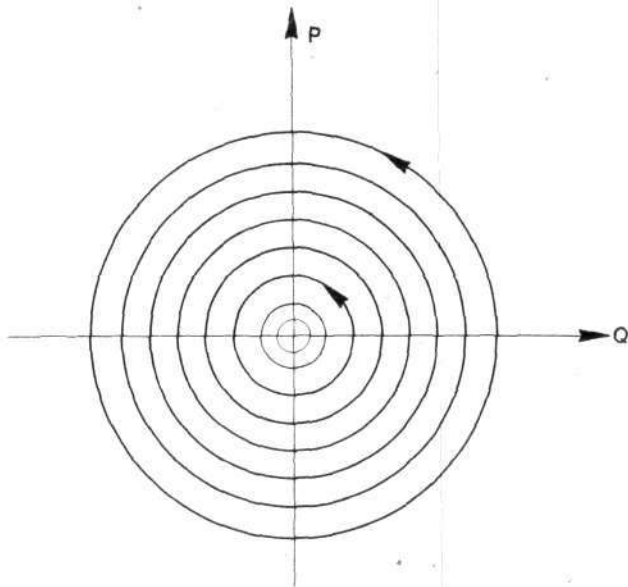

(d)  
THE FAMILY OF ORBITS  
IN THE NEW PHASE SPACE

By looking at possible orbits for different values of  $J$  [different energies], a fluidlike vortical flow pattern is generated. All the orbits are directed counterclockwise, like the whirlpool motion of a vortex.

However, McGehee has discovered a geometry that clarifies the underlying physics of the collision. He begins by examining the orbits of the particles in phase space rather than physical space (the  $x$ - $y$  space as in Figure 2). Phase space is formally a higher-dimensional space in which a point specifies not only the position of the particle in physical space, but also its velocity (or, equivalently, its momentum). The orbit of a particle in phase space then gives the position and velocity of the particle at every point in time.

### Phase Space

The concept of orbits in phase space is so basic to an understanding of the geometry of physical law that I will develop a more detailed example here of its usefulness in the geometry of three-body collisions.

Let's look at the motion of a pendulum in physical space and then in phase space. Figure 3a depicts the motion of a pendulum schematically; the orbit of a particle at the end of the pendulum is the arc of the circle it describes as it swings back and forth. The orbit shown in physical space does not tell us much about the velocity, but it is clear that the velocity is zero at each end of the swing, and is greatest in the middle of the swing. That is, when  $x = 0$ , the velocity is its maximum; when  $v = 0$ , the position,  $x$ , is at its maximum.

Let us call these maximums  $v_0$  and  $x_0$  respectively. This periodic motion (periodic means that the pendulum bob retraces its path over and over in an identical way each time) is similar to the motion of the near-collision in Figure 2 in its energy relations. When the particle in Figure 3 is at its maximum,  $x$ , its potential energy is the greatest (that is to say, it is the highest off the ground and is has energy of position in the gravitational field), and its energy of motion ( $\frac{1}{2}mv^2$ , its kinetic energy) is zero. The available energy is then interchanged between kinetic and potential at the middle of the swing, where the potential energy is zero (that is the lowest point in its orbit so that all potential energies are defined relative to it) and the kinetic energy is maximum.

An appropriate geometry for studying the motion of the pendulum should show these relations between the kinetic and potential energy, and allow us to take advantage of the constancy of the total energy. We can devise such a geometry in two steps:

(1) Construct a phase space, in the sense defined above, with  $x$  as one coordinate and  $v$  as the other. Plot the pendulum orbits in this space.

(2) Make any coordinate transformations that clarify the energy relations in the system.

Figure 3b shows the results of a simple phase space diagram for the pendulum of Figure 3a. The swinging motion of the pendulum now appears as an ellipse. The point marked A corresponds to point A in Figure 3a, where the pendulum is at its point of maximum swing to the right; the trajectory rotates counterclockwise on the ellipse.

The orbit is closed because the motion is periodic. Notice, however, that the phase space is two dimensional (that is,  $x$  and  $v$ ), but that the orbit is only one dimensional. The orbit cannot go anywhere in the phase space

but is very tightly constrained to lie on an ellipse. This ellipse is specified once the energy is given or, equivalently, once the amplitude of the swing is determined. In a mathematical sense, the constancy of energy defines an algebraic relation between  $x$  and  $v$  (the sum of the kinetic energy and potential energy must be equal). This algebraic relation then ties together  $x$  and  $v$  so that they cannot vary independently. In general, each distinct algebraic relation reduces the dimensionality of the orbit by one, because this relation restricts the independent variation of the coordinates.

The constancy of the energy is still not clear in Figure 3b. However, we can make a change in coordinates so that the problem is reduced to an almost trivial inspection of the phase space orbits in the transformed space. It is intuitively clear that if we changed the units in which we measured  $v$  and  $x$  so that the maximum value of each in the new units were equal, the orbit would then be a circle. The new coordinates that result, called the *action-angle coordinates*, have the additional property that the trajectory is now traced out with constant *angular velocity*. That is, in this transformed space, the orbit is a circle and the particle travels around this circle at a constant rate (Figure 3c). The radius of the circle is the square root of the energy (called  $J$ ) and the frequency of rotation of the orbit is just the frequency of oscillation of the pendulum (called  $\omega$ ).  $J$  and  $\phi = \omega t$  are the so-called action-angle variables, the natural coordinates for studying the motion of the pendulum.

One final point necessary for an attack on the three-body problem is as follows: For any one orbit,  $J$  (the energy) is fixed, but by varying  $J$ , we can generate a family of orbits, or a *flow*. This flow has the important property of behaving like a fluid (specifically, an *incompressible fluid*) in phase space, and because of this, all the mathematics and physical intuition that apply to the study of fluid flow can be applied to this problem. Figure 3d shows the flow associated with the pendulum, which looks like a vortex.

The continuity properties of this flow play a key role in analyzing the near-collisions of the three-body problem. The method of using such flows on a so-called natural geometry was first tried with great precision by Bernhard Riemann. His ideas and their application are brilliantly summarized in Felix Klein's little book, *On Riemann's Theory of Algebraic Functions and Their Integrals*.

In a purely formal sense, the equations describing fluid flow on a surface and phase space orbits are identical. This similarity comes primarily from the fact that both systems can be described by Riemann's theory of analytic functions because they are *topology preserving*, a property that distinguishes analytic functions. That is, for a given set of parameters (energy and so forth), the evolution in time of the fluid or orbits conserves the topology of the streamlines or orbits. Specifically, they remain describable by the same *analytic functions*. In other words, the flow lines cannot change the number of times they cross, new vortices cannot appear, and so forth.

The mathematical conceptions that Riemann used to describe this very restricted class of functions is based on the observation that since the number and kind of singu-

larities (like vortices for fluids or the structure of Figure 3d for phase space orbits) cannot change, there must be a way of characterizing the whole flow on the basis of the invariance of the singularities.

Riemann was able to carry out this program for analytic functions and to lay the basis for a mathematical description of these physical systems in terms of their singularities. The key is his concept of the relation between the *continuous flow and the discrete singularities*. The global continuous field (the flow of orbits) allows singularities to exist. However, these singularities, even when only points, cannot be abstracted from or removed; they reciprocally define the global geometry of the field. As Klein commented:

Among the numerous *accidental* properties of the functions, we distinguish certain essential ones which are unaltered by uniform transformations. And in the number  $p$  [of cuts that can be made in a surface without dividing it into separate pieces] especially such an invariative element presents itself at the outset. Thus Riemann's theory... proceeds at once to determine in what way the functions in question are arbitrary. This was accomplished in the proposition: *the infinities [singular points] of the functions and the moduli of periodicity of its real part at the cross cuts, are arbitrary and sufficient data for the determination of the functions [emphasis added]*.

That is, once the singular points (and, secondarily for our purpose, their periodicity) are specified, the function is *completely specified*. This is the concept that must inform physics; it is the antidote to *reductionism*.

### Three-Particle Phase Space

The phase space for three particles, each of which has three position coordinates ( $x, y$ , and  $z$ ) and three velocity coordinates (velocities in the  $x, y$ , and  $z$  directions) is an 18-dimensional space. That is, to specify a point in the phase space, we need to have 18 numbers (nine spatial coordinates and nine velocities).

McGehee makes this rather large space manageable by restricting his examination of collisions to those in which the particles either enter or leave the collision nearly along a line. (The collision pictured in Figure 2 falls into this class, since the three particles are nearly collinear after their near-collision.) This reduces the 18-dimensional space to a 6-dimensional one, in which the position (along this line) and a velocity (along the line) must be specified for each particle to describe the complete configuration and dynamics of the three particles.

As in the case of the pendulum, we can further reduce the dimensionality of the space that describes the orbits of the particles by using the laws of motion (Newton's Laws) to derive algebraic relations between some of the coordinates. Specifically, the following three relations mean that the orbits in this six-dimensional space are restricted to a three-dimensional subspace (a constant *energy surface*) of the total phase space:

(1) *Conservation of energy.* This relationship among the velocities and positions means that only five of the six are independent of each other. Thus, this condition restricts the orbit of the system in phase space to a surface of five dimensions in this six-dimensional space.

(2) *Conservation of momentum.* This is a relation among the three velocities that further reduces the dimensionality of phase space accessible to the orbit.

(3) *Fixed center of mass.* Since it is irrelevant whether the group of particles as a whole is moving with some constant velocity, we set this velocity equal to zero.

We can make a final simplification of this now three-dimensional phase space by defining the part of it in which collisions occur. The condition that ensures that the three particles collide defines a two-dimensional surface in the three-dimensional space of possible orbits. This surface is called the *collision manifold* (see Figure 3) and its properties allow the description of the bizarre properties of near-collisions. The three-dimensional space in which the orbits occur is the *volume* inside the surface.

To summarize the argument up to this point: We have defined a space whose coordinates give both the velocities and positions of particles. As we shall see, this space is the *natural geometry* for studying the dynamics of the collisions of these three particles. In this space an orbit for the collection of three particles is a single line. Since we are working in phase space, the state of the whole system is specified by a single point. As it moves, the point traces out a *world line*, not three lines (one for each particle). If the particles collide, then this orbit intersects the collision manifold; but, in any case, the motion of the three particles is restricted to the three-dimensional space shown in Figure 3.

### The Collision Manifold

Now we must find some general characterization of the structure of the orbits in this phase space, especially those that intercept the collision manifold. To do this, McGehee uses Riemann's theory of algebraic functions. Riemann recognized that a space like that depicted in Figure 3 is not an undifferentiated, simple continuum; it has a structure specified by the singularities that exist in the space. Just as in the pendulum example, if one can qualitatively describe these singularities, then the *texture* of the space can be described with great generality.

Using a hydrodynamic analogy, Riemann proved that this texture is given by the flows the space can support. That is, once the boundaries and singularities are determined (in this case by the forces that are singular when a collision occurs, the geometrical constraints of collinearity, collisions, and so on), if the dynamics are then described by orbits of a "Newtonian" flow, these flows are determined by the singularities. Thus, the local characteristics of the manifold (those near the singularities) specify the *global features of the manifold*. To go back to our original example, then, the flows of confocal ellipses structure the phase space for the orbits of the simple pendulum.

As Klein discusses at length in his book on Riemann's theory of algebraic functions, if one specifies the vortex

flow in the neighborhood of the vortex center—no matter how small that neighborhood—and if there are no other singularities\* then only one kind of flow is possible. This is an incredibly powerful deduction about the mathematically idealized system: The description of the flows in a microscopic region, as long as it includes the singularity, suffices to determine the global flows of the system.

### Riemann's Contribution

The *methodological importance* of Riemann's concept as it helped generate a developed idea of phase space is twofold. First, the real geometry in which a physical system exists is not the apparent real space or time. An evolving system actually functions in a dynamically determined "phase" space—a space that is mutually determined along with the behavior of the system. It may seem that there is a pendulum clock in the livingroom. But that clock actually exists in a phase space (see Figure 3) whose structure and characteristics are a product of the evolution of the clock; that is, its constant angular period of pendulum oscillation. Phase space is not only a mathematical construct; it is much more real than the physical space we know from common sense.

Second, the implied structure of phase space allows the immediate identification of the most critical features of even simple systems, those that would otherwise seem to be obviously susceptible to reductionist analysis—the three-body problem, for example. In reality, the properties of a system of three particles are not determined by their particulate nature and fixed pair interactions; rather, it is due to a continuous fluidlike property (see Figure 3d) that the actual (phase) space imposes on them. This underlying continuity is the *crux of the problem—and solution—*of the three-body problem.

The task in terms of refuting the reductionists is clear: We must find the flows for the three-body problem. The method described by Klein has an immediate application to the manifold shown in Figure 4b, and McGehee used it to describe the orbits that either end or begin in triple collisions. The outline of McGehee's argument is as follows:

(1) The flows on a three-dimensional space (limited by the conservation of energy and momentum and by the condition stated above on the center of mass) are well defined. However, the flows are not well defined at the point that a collision occurs, because there the equations of motion break down. That is, a  $1/r$  potential is not defined for  $r = 0$ . Therefore, we must make some mathematical modification of the orbits so that we can define a flow through the collision manifold as well as elsewhere.

The equations of motion do not suffice to explain what happens when the particles collide since the interaction ( $1/0$ ) is infinite at the point of collision. This is a trivial task for the collision of two particles, for there the particles bounce off each other. But it can be proven that there is no consistent way to connect or regularize the orbits either

\*That is, the space is otherwise simply connected.

before or after a *triple* collision. In other words, there is no analogy to an elastic bounce that defines the connections of orbits through a two-body collision. Figure 4b shows a space in which orbits can end or begin on the collision manifold, but cannot be connected to each other on the manifold.

(2) If a mathematical description of the flows on the triple collision manifold can be given, then we can progress. These flows do not correspond to any actual particle motion, since every point on the collision manifold corresponds to a triple collision. However, the continuity properties of the flow allow us to say that the flow close to the collision manifold must correspond to the flow on the manifold. Therefore, the flow on the singular manifold has the same properties as the flow (orbits) of particles that almost collide, and we can describe near-collisions (like that in Figure 2) by means of the flow on the collision manifold.

(3) Now using the flows on the collision manifold, we can show why orbits cannot be regularized through a triple collision, and, in addition, we can derive two pathological properties of triple near-collisions. These two results are the basis for the striking implications of the three-body problem mentioned earlier: first, the fact that one particle can leave a triple near-collision with arbitrarily large velocity; and second, that the pairing of particles as they leave the collision is not a continuous function of the initial conditions. Each result has the same, noncausal implications; namely, that arbitrarily small changes in the initial conditions of the three particles can result in arbitrarily large differences in the final velocities and configuration of the particles after a near-collision.

Keeping the structure of McGehee's argument in mind, we now reconstruct his reasoning in more detail. Figure 4 depicts the phase space for the three particles; this space does not yet have flows, but we can gain some initial insight into its structure by carefully examining the coordinates. These new coordinates correspond to the *action angle* coordinates for the pendulum. They are the natural measures in the space defined by the dynamics.

s. This coordinate measures the configuration of the particles. Notice that when the colliding particles are restricted to a line, they cannot change their order;  $M_1$  is always to the left of  $M_2$ ,  $M_2$  to the left of  $M_3$ . When  $s$  is equal to  $-1$ , then  $M_1$  and  $M_2$  coincide (that is, there is a two-body collision); and when  $s=1$ , then  $M_2$  and  $M_3$  collide.

v. In the cases of interest here, this coordinate measures the velocity of the particles as they recede or approach each other, with one pair of particles moving together. This configuration is clearest in the case of orbits that lie in one of the four "legs" of the manifold. Here,  $s$  is near to 1 (in absolute value) and so  $M_2$  is near to either  $M_1$  or  $M_3$ . When this is the case, then  $v$  is very large. This geometry then expresses the qualitative feature evident in the near-collision shown in Figure 1. When  $M_1$  and  $M_2$  are close together,  $M_3$  is escaping rapidly.

w. This coordinate is a measure of the relative velocity of the middle particle. The shape of the manifold for a

# Phase Space for

Figure 4

The three diagrams here show the same process of abstraction used to deduce the phase space for a pendulum [Figure 3] for the three-particle system. Diagram 4a, the same as Figure 2, shows the orbits of a near-collision of three particles in physical space. Diagram 4b corresponds to Figure 3, and shows the actual, dynamically determined geometry in which the near-collision occurs. This space shows the possible motion of the three particles in the same way that the circular orbits of Figure 3c showed the behavior of the pendulum. The coordinates of this phase space [called  $s$ ,  $w$ , and  $v$ ] correspond to the two new coordinates,  $P$  and  $Q$  for the pendulum. Diagram 4c, in analogy with Figure 3d shows the global texture of the phase space of Figure 4b. The possible orbits of the particles are shown by their trajectories on this surface and are much more complex because of the highly nonlinear dynamics of the system. In this phase space, the surface on which the particles appear is no longer "smooth." It is like the grooved surface of a record, which restricts the motion of the system to very specific directions and paths on the surface, and whose totality forms a fluidlike flow in phase space. Only in this highly abstract space can the actual motion of the particles become understandable.

Figure 4a

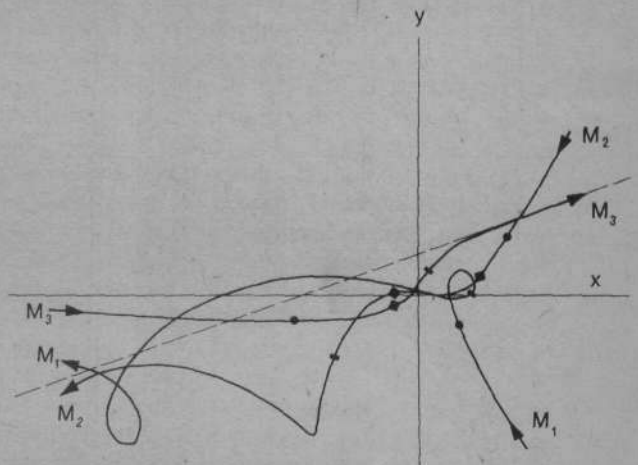

# a Three Particle Near-Collision

**Figure 4b**  
THE THREE-DIMENSIONAL PHASE SPACE  
IN WHICH COLLINEAR MOTION  
OF THREE POINT PARTICLES OCCURS

The surface is the manifold on which triple collisions occur. The coordinates are as follows:

$s$ : the configuration of the particles.  $s = 1$  corresponds to  $M_2$  and  $M_3$  colliding;  $s = -1$  corresponds to  $M_1$  and  $M_2$  colliding.

$w$ : measure of the velocity of  $M_2$  relative to  $M_1$  and  $M_3$ .

$v$ : a measure of the relative velocity of the outside particles,  $M_1$  and  $M_3$ .

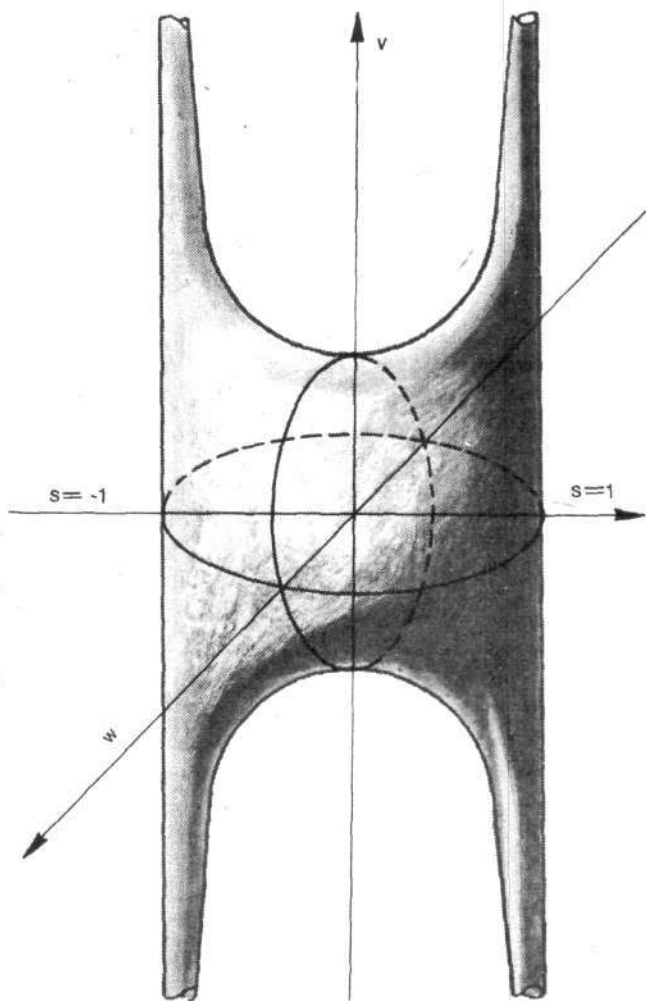

**Figure 4c**  
TWO TYPES OF FLOWS  
AFTER A TRIPLE COLLISION  
ON THE COLLISION MANIFOLD

Each line represents a trajectory of the three particles receding from a triple collision. The orbits spiraling up the left leg of the collision manifold are collisions in which  $M_1$  and  $M_2$  are close together [see Figure 1 for an example]. Dotted portions of an orbit indicate motion on the far side of the surface. All flows begin at point  $c$  and leave with the same slope.

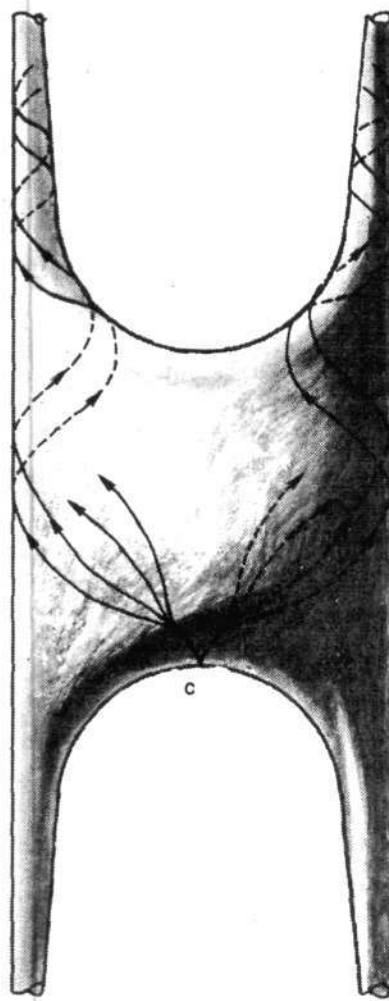



constant value of  $v$  is a circle in the  $w$ - $s$  plane because  $s$  can change only when  $w$  does; that is, only the movement of the middle particle changes the configuration.

Figure 4c shows one set of flows (or orbits) that occur on the collision manifold.\* The orbit of an actual group of three particles would occur inside the volume shown in Figure 4b, but since we are interested in the orbits that have near-collisions, we need find only the flows near the surface where actual collisions occur. Using the hydrodynamic analogy from Riemann, which applies rigorously here, we can determine the properties of the near-collision orbits from the fictitious orbits on the surface. (They are fictitious, as pointed out above, since every point in the surface corresponds to a collision).

The orbits in Figure 4c have been drawn from an examination of Newton's equations of motion in the new coordinates. The mathematics of the derivation need not be examined here, but its implications for the three-body near-collision can be deduced from the flows. As Figure 4c shows, all the orbits after a near-collision begin at the same point (labelled  $c$ ) and then spiral up one leg of the surface. All the orbits start infinitesimally close to one another; this is the crux of the difficulty.

Because of this crowding of the orbits at  $c$ , an infinitesimally small change in an orbit at the point  $c$  can put the particles in a totally different configuration, resulting in an orbit going up a different leg. (Orbits of both kinds are shown in the figure.) However, even more important, the same argument shows that there are orbits with arbitrarily high velocities (in  $v$ ) and that there are neighboring orbits with arbitrarily large differences in final velocities. These three characteristics (arbitrary configuration, arbitrary velocities, arbitrary large enhancement of infinitesimal differences) all result from the structure of the flows on the collision manifold.

### Geometry and Causality

A true notion of causality depends on an understanding of the natural (Riemannian) geometry of the universe and on understanding the critical role singularities play in determining this geometry and, hence, in determining the nature of causality. In an intuitive way, I have described these singularities as marginal effects—the property of a nonlinear system whereby a small cause can have effects that not only are very large but also can change the geometry of the system.

This is not the case with the three-body near-collision. It is true, as McGehee and Waldvogel showed, that a small change in initial conditions can result in a large change in the system, but this is not even a model for a correct notion of causality. In fact what McGehee and Waldvogel describe is an inherently acausal system. The difference between these two kinds of small causes with large effects is clear when one examines the role of singularities in determining causality. In the case of the near-collision, there is no singularity; rather, the continuity of the orbits is the problem. At the point  $c$  in Figure 4c, an infinitesimally, that is, continuous small change in the orbit has an arbitrarily large effect. Such a situation is totally acausal.

Notice, even so, that the mathematical tools required to show this result depend on singularities, and are suggestive of the way that our notion of causality must also be singular. The point  $c$ , for example, is just such a singularity that has global structuring effects.

A singular causality is required. On epistemological ground, it is clear that a causality derived in analogy with the role singularities play in structuring a Riemannian geometry has two interrelated qualities:

(1) It describes a restricted sort of determinist causality within the confines of that given geometry. In other words, the metric (which the space has in part because of the singularities) is fixed. This metric then allows a determinist description of orbits within the manifold.

(2) Moreover, singularities exist that can change the structure of the manifold. Such singularities, either intrinsic or arising out of a dynamic property of the geometry and orbits, can result in a nondeterminist change to a new manifold. The succession of manifolds is lawful (that is, causal), but is not determinist. A nondeterminist causality specifies some invariant property of the transition, and the new causality that then holds within the second manifold again must be internally specified.

A second set of new results in the study of the three-body problem provides an example of this sort of singularity. These results do not show a transition from one manifold to another, but they provide an example of the breakdown of one manifold associated with a singularity. At this point, such a result can best be found in the physical sciences—a Riemannian treatment that shows the point at which the present manifold must change but cannot take us from one manifold to the next.

### RECENT RESULTS FAR FROM COLLISION

[We must] attempt to construct a theory in which motion would be an inseparable property of the object, and would not be the result of the action of any "sources" [forces in classical mechanics; the heat reservoir in statistical mechanics; and charges and currents in electrodynamics]. The effect of sources of this nature is that in essence the motion is introduced into the physical system from without.

—A. A. Vlasov, 1951

Another contemporary line of attack on the three-body problem has concentrated on interaction of three particles far from any collision. The empirical systems corresponding to this problem occur in astrophysical

\*There is a similar set of orbits that leads up to a triple collision; however, as noted above, McGehee showed that the orbits before and after the collision cannot be consistently connected. Figure 4 also exaggerates one feature of the orbits that can be deduced from McGehee's work, although he does not mention it. All the orbits leave the point  $c$  with the same slope. This is another expression of the irreducible indeterminacy of the problem, since all the orbits are "so close" together at  $c$  that they cannot be causally separated.

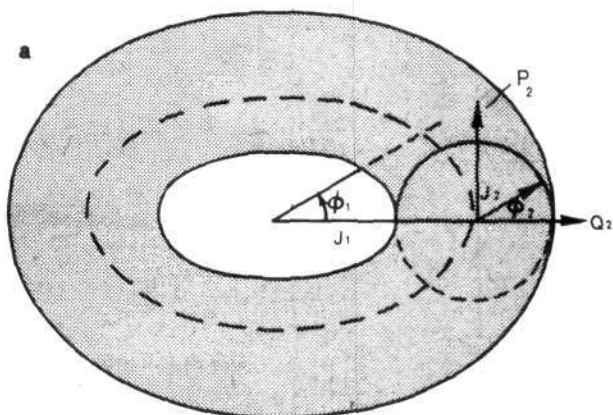

(a)  
THE PHASE SPACE FOR TWO  
INDEPENDENT HARMONIC OSCILLATORS

$J_1$  and  $J_2$  are the inner and outer radii of the torus, and  $\phi_1$  and  $\phi_2$  are the angular coordinates. Notice that every point on the torus has the same value for  $J_1$ . This is a problem of depicting a four-dimensional space as a three-dimensional torus. This phase space is equivalent to the circular orbit of the pendulum [Figure 3c]. Here the physical system has a motion so much more complicated that the equivalent of Figure 3a—"real space"—cannot be drawn.

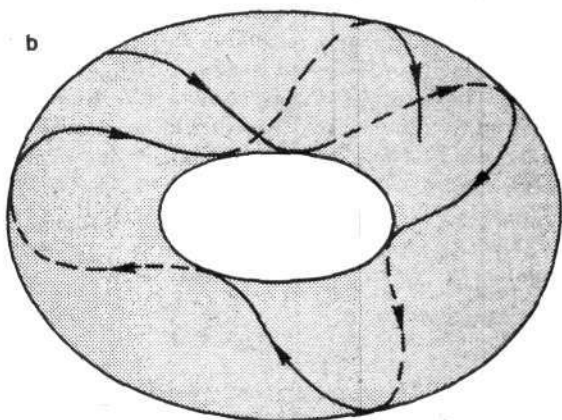

(b)  
A TYPICAL ORBIT OF TWO  
INDEPENDENT OSCILLATORS

If the frequencies of the two are incommensurable, the orbit never joins itself. Eventually, the orbit covers the whole surface of the torus. The dotted portions of the orbit indicate that the orbit is on the far side of the torus.

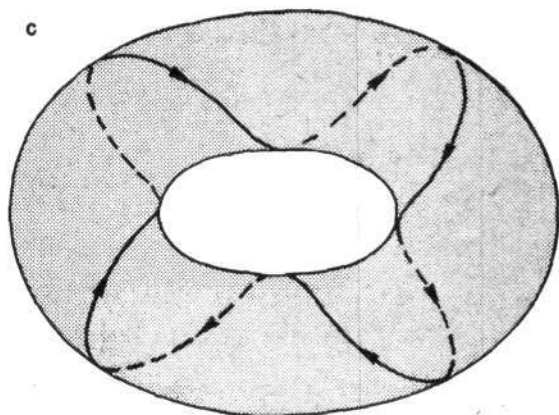

(c)  
AN ORBIT FOR OSCILLATORS  
WITH FREQUENCIES IN THE RATIO 1:4

The orbit circles the small part of the torus four times in the time it takes to get around the major radius once. Since the ratio of the two frequencies is a rational number, the orbit is closed, and forms a line rather than sweeping out the whole surface as in b) above.

Figure 6

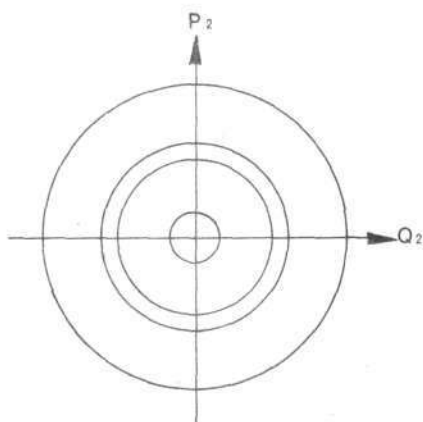

(a)  
THE LEVEL SURFACES  
FOR THE ORBITS OF FIGURE 5b

This figure can be thought of as representing a cross section of one-half of the torus, with each of the level curves for a different value of  $P_1$  [this is equivalent to different values of  $J_2$ ]. These circles are not orbits themselves, but rather the locus of intersection between the torus-filling orbits of Figure 5b and the  $P_2, Q_2$  plane.

This diagram corresponds to Figure 3d showing the structure of the space.

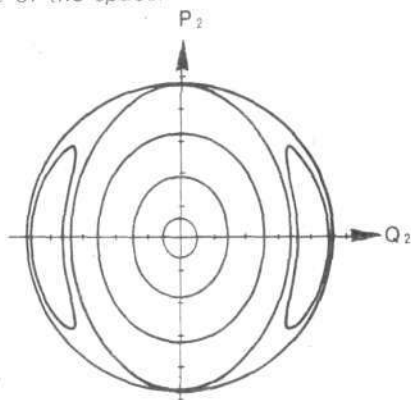

(b)  
THE LEVEL CURVES  
FOR THE OSCILLATOR SYSTEM  
WITH THE SIMPLEST NONLINEAR COUPLING

This coupling is proportional to the  $\cos [2\phi_1 - 2\phi_2]$ . The angular factor is responsible for the pair symmetry evident here. The self-intersecting orbit is a dynamical singularity.

The critical change in this example compared with the linear pendulum of Figure 3 is that the flows depend on the interaction. Since the interaction is nonlinear, the underlying structure of the space can change as the energy of the system increases.

Source: Walker 1961

situations (the earth, the sun, and a satellite, for example) and in the study of triatomic molecules.

Both systems exhibit properties that cannot be derived from classical (nongeometric) analyses of Newton's equations. The astrophysical problem is the following: Many stellar motions occur in a configuration where one of the stars can be thought of as moving in a fixed field. The motions of the star in this situation should be subject to two conservation laws of energy and angular momentum (relations which, as above, restrict the orbits to some smaller dimensional part of phase space). There is considerable observational evidence, however, that the orbits are restricted by a third condition. This additional constant of the motion cannot be derived mathematically, and, in fact, the French mathematician Henri Poincaré proved that no other exact constant of the motion can exist.

The explanation of this additional observed constraint on planetary motion turns out to be also involved in predicting the breakup of a triatomic molecule. A number of chemists have observed that as energy is added to a triatomic molecule, the energy is stored in one mode or another of the molecule (vibrational energy, rotational energy, and so on), but the modes do not exchange the energy among themselves. In other words, at low energies the molecule behaves like a linear system, with well-defined and separable normal modes. However, as the energy increases, there is a sudden change to a situation in which the modes freely exchange energy, and the molecule rapidly disassociates.

Both the astrophysical and the triatomic system have a quite small phase space, and an analysis similar to that above for the collisions of the three-body problem shows that when in motion far from collisions, such systems have four dimensions. That is, we must specify two velocities and two positions.

This phase space, like that of Figure 4b, is not a physical space; it represents two modes of energy content that the system can support, called normal modes. The key to the problem, is that the two modes are not independent; they are said to be "coupled by a nonlinearity." Each mode separately acts like a pendulum, but there are conditions in the three-body problem that result in the modes interacting with each other in some specific way that allows them to interchange energy.

For an analysis of the three-body problem reduced to the interaction of two pendulums (harmonic oscillators) to make sense, the coupling between the oscillators must be small. The question is, what does small mean? As a Riemannian treatment shows, even a small nonlinearity can change the geometry of the orbits in a qualitative way. When this happens, the one geometry can break down entirely and cease to be the natural geometry for examining the problem. This is the case, for example, when the molecule disassociates. The laws governing its behavior change entirely as soon as the atoms separate; different forces, different electron arrangements, different masses, now determine the interaction of the three separate atoms.

As we shall see, the qualitative change introduced by the nonlinearity to the triatomic molecule is a previously

nonexistent singularity in the geometry. This small singularity is unavoidable. It determines the character of causality within the manifold in conjunction with the rest of the space; and, if the energy is high enough it can then change the whole manifold.

Before turning to the recent work done on this part of the three-body problem, we must look at the phase space of two uncoupled pendulums or oscillators. Figure 5 shows the phase space for two oscillators with action-angle coordinates  $J_1, \phi_1$  and  $J_2, \phi_2$ . The doubly periodic space is shaped like a torus (donut) where  $J_1$  and  $J_2$  are constants of motion (each energy is a constant separately).

Since there are two constants of motion, the orbits are restricted to a surface with two dimensions fewer than the dimensions of the phase space. The resulting two-dimensional manifold is the surface of the torus. Figure 5b shows one orbit, which is not closed, and Figure 5c shows another orbit, which is closed. The two possible types of orbits differ because of the existence of an additional constant of motion for the orbit that is related to the frequency of the oscillators. This results in the restriction of the orbits to a now one-dimensional part of the four-dimensional phase space.

The condition for an orbit being closed on the torus is that the frequencies of the two oscillators must be integrally related, or that the ratio of the two frequencies must be a rational number. The frequencies in Figure 5b are incommensurable, and so the orbit never reconnects.

#### Dynamical Singularities

If the two oscillators are coupled together, there is only one constant of motion,  $J_1 + J_2$  (the total energy), and the orbits are restricted only to a three-dimensional surface (here a volume) in the four-dimensional space. This is the Poincaré constant of motion.

Before studying this further, we must solve a technical problem of drawing these three-dimensional orbits on two-dimensional paper. Two astronomers who attacked the problem of the three-body interaction (Henon and Heiles 1964) devised a useful graphic technique. Their method is based on the following argument. We are interested in the cases where there is a second constant of motion that would make an orbit two-dimensional. Therefore, we must be able to isolate two-dimensional orbits.

If we fix one of the coordinates (say,  $Q_1$ ) and look at possible orbits ( $P_1$  having specified values) in the ( $P_2, Q_2$ ) plane, then orbits with an additional constant of the motion will intersect this plane always in a line, while orbits without the constant will wander throughout the plane. This construction is equivalent to taking a cross-section of the torus (the  $P_2, Q_2$  plane) and examining the intersections of the orbit with the plane. For different values of  $P_1$  and with  $Q_1 = 0$ , this will generate a family of curves, called level curves.

Figure 6a shows what happens when this technique is applied to the orbits of Figure 5b. The result is a set of concentric circles, because, of course, there are two constants of motion when the oscillators are independent. Notice that the level curves are complete circles because the orbit eventually covers the whole torus. If we had done the

Figure 7

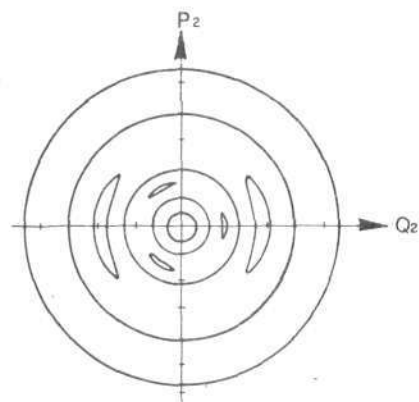

(a)

THE LEVEL CURVES FOR THE OSCILLATOR SYSTEM WITH A NONLINEARITY WHICH IS THE SUM OF THE FIRST TWO TERMS OF THE FOURIER SERIES

The double island is due to the same term as is shown in Figure 6b, and the triple set is due to a term proportional to  $\cos [3\phi_1 - 2\phi_2]$ . The energy is low enough that triple islands are still separated from the double set. These flows structure the space of the system in a way whose quality changes as the system evolves.

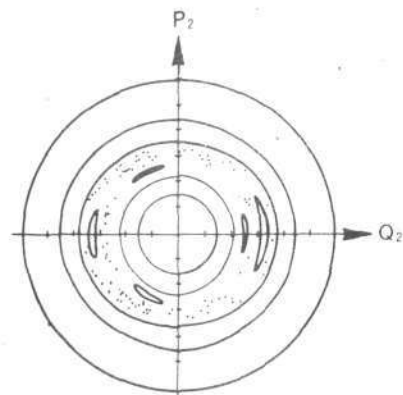

(b)

THE LEVEL CURVES AS IN FIGURE 7a FOR A HIGHER ENERGY

As the energy is raised, the two sets of islands begin to overlap. At this point, the separatrices cease to be orbits restricted to a two-dimensional surface and become three-dimensional. The intersection of such an orbit with the plane is shown by the dots that appear in the area near the islands. The motion of the system is nonperiodic in this area.

Source: Walker 1961

same for Figure 5c, the result would have been one point.

Using this technique we can go on to study the effect of coupling (a nonlinearity) between the oscillators. The nonlinear coupling that describes the three-body problem can be broken down into a sum of simpler nonlinearities and a study of each of these terms separately is the next step in understanding the role of the coupling.

Figure 6b shows the effect of the first and simplest of these nonlinearities. The level curves are almost unchanged from Figure 6a, except near the edge of the diagram, where one orbit intersects itself forming a separatrix and cutting off two islands. The position of the separatrix depends simultaneously on the strength of the nonlinearity and on the energy of the system. When the energy or nonlinearity increases, the separatrix (and islands) moves out from the center of the diagram.

For some energy, however, the separatrix appears and the qualitative nature of the geometry of the flows in phase space changes, when a dynamical singularity is introduced at the point that the orbit intersects itself.

Now, with only one term from this sum of nonlinearities, the system undergoes no other changes, as the energy increases. There are still two constants of motion, and the system is well-behaved. But as soon as there are two of these terms in the coupling, then a dramatic change occurs. (The actual three-body interaction has an infinity of these terms in the expansion of the coupling.)

Figure 7a shows the level curves for a relatively low energy of a pair of oscillators coupled by the first two nonlinearities in the Fourier series. The same two islands are apparent, and in addition, a set of three islands with its own separatrix appears.

As the energy is raised, the islands move out from the center of the  $P_2$ ,  $Q_2$  plane and begin to overlap. The situation at a higher energy is shown in Figure 7b. As soon as the islands approach each other, the area of the plane where the separatrices were changes fundamentally; the additional constant of the motion is no longer conserved, and the orbits become three-dimensional. This situation is shown in Figure 7b, where the orbit depicted in this area of overlap intersects the plane seemingly at random.

In Figure 8, the same sequence of increasing energy level curves is shown for the full three-body nonlinearity. Again, as the energy increases the singularities in the orbits, introduced by the nonlinearity, become the areas of the phase space that lose their two-dimensionality and the additional constant of motion.

#### Amplitude Instability

The sudden onset of the breakdown of the well-behaved, two-dimensional orbits is called an *amplitude instability* and corresponds exactly to the empirically observed behavior of the triatomic molecule described above. As soon as the modes begin to interchange energy (that is, as soon as the energy of each separately is not conserved and the orbits are no longer constrained by the additional constant of motion), the behavior of the molecule changes abruptly and it disassociates. The converse process can be observed in the empirically determined

constant of motion in the astronomical case. *This breakdown occurs precisely at the separatrices, the singularities in the orbits introduced by the nonlinearity.* The motion of the three-body system is lawful and determinist for low energies, before the onset of the amplitude instability, but after the instability its motion no longer can be described by simple Newtonian mechanics. When still looked at in the "old" geometry, its orbit begins to share some of the wild, ergodic characteristics of the collision orbits (e.g., a small change in initial conditions has an arbitrarily large effect).

The laws governing the behavior of the system have changed abruptly, because of the change in the manifold induced by a singularity. The previous phase space is no longer adequate for an understanding of the motion. The new laws demand a new geometry.

This dramatic, qualitative change in the behavior of a three-body system is not merely a mathematical phenomenon. In real systems a similar phase change is observed in the breakup of a triatomic molecule. The chain of events in the molecule is identical to that seen in the theoretical model. The previously independent (and linear) modes of the system suddenly interchange energy so strongly that the periodic orbits, which accounted for the system's stability, disappear. In a sudden, wild transition, the molecule breaks apart.

After this violent transition, the laws governing the system—the stable, bound states of the three nuclei and their electrons—cease to be the determining feature. They are superseded by collisional, plasma, and radiation dynamics of the complex system of charged particles and electromagnetic fields produced by the breakup of a molecule.

There are two essential features here to reckon with. First, the resulting collection of entities cannot be derived from the previous state of the system. The final state of the system is not deterministically connected to its initial state. Mathematically this takes the form of the extreme irregularity of the phase space orbits after the transition. In reality, the point is obvious: These orbits are a mathematical fiction. The actual atoms (or planets) do not follow these trajectories, because the original particles no longer exist! The onset of the wild orbits serves only as a signpost that some qualitative change in the laws governing the system has taken place. Even with this proviso, the mathematical properties of the new orbits are maximally random. Although the rigorous mathematical details of this are still unknown, the current conjecture is that after the amplitude instability the orbits are ergodic. In other words, these orbits are so erratic that they can be studied only statistically.

#### The Plasma Model

The second point that follows from the existence of this breakdown of simple orbits in phase space comes from plasma physics. In exactly the cases where the wild, statistical behavior of a physical system seems to force entropy and the Second Law of Thermodynamics on us, other processes appear that create order. This is precisely what

## The Qualitative Change in the Phase Space of a Nonlinear System as the Energy Increases

(a)  
THE LEVEL CURVES FOR THE THREE-BODY INTERACTION, FAR FROM COLLISION

The energy here is 0.083. The orbits are well behaved and the system has a second constant of the motion.

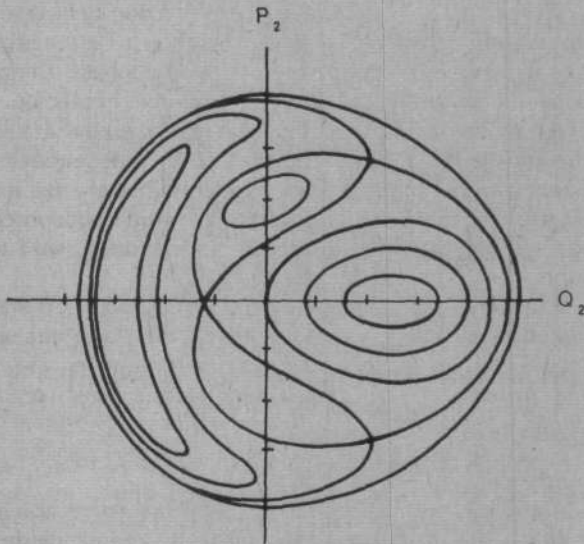

(b)  
THE LEVEL CURVES FOR FIGURE 8a WITH ENERGY NOW 0.106

The areas where the separatrices used to be are now filled with unstable orbits [not shown].

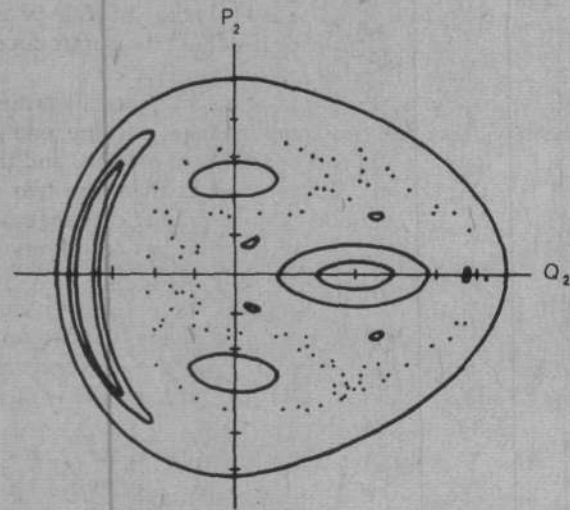

(c)  
THE LEVEL CURVES AT A SLIGHTLY HIGHER ENERGY, 0.125

The unstable orbits now fill almost all of the phase space.

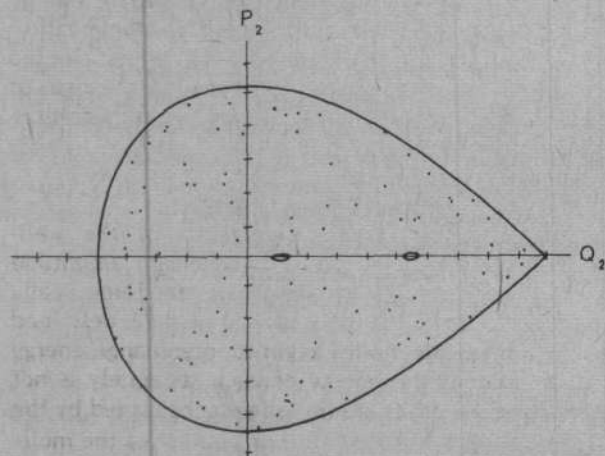

All three diagrams are conceptually equivalent to Figure 3d, but because the system is nonlinear, the underlying texture of its actual geometry changes as the system's energy increases. While the pendulum was characterized by the same concentric circles no matter what the energy [precisely because of its linearity], a nonlinear system, for very low energy has a similar set of fluidlike fixed orbits, as in diagram a. As the energy increases, however, a qualitative change occurs in which the texture of the space becomes singular. This qualitative change takes place in a very small energy range [b and c] and is the characteristic feature of actual geometries in the world. Here the real power of Riemann's prescription for a "dynamically determined" geometry becomes evident.

Source: Henon 1964

happens in a plasma. A plasma, a complex collection of charged particles and fields, is not describable statistically. In fact, just the opposite is the case. Statistical descriptions average over the most important features of the system. Where statistical mechanics would predict a rapid descent of a plasma into uniformity and quiescence, the plasma bunches up its energy, creates complex geometric structures, and generates order in a chain of evolution that leads ultimately to the dense energy concentration that produces fusion.

Take the mundane example of a triatomic molecule like water,  $H_2O$ . As steam is heated, the internal modes of the water molecule, both vibratory and rotatory motions, are excited and the molecule moves more and more rapidly. At a certain well-defined point, the amplitude instability (or some related process) sets in and the molecule dissociates into a collection of particles and radiation. If the steam is hot, the atoms stay separate and quickly are ionized to form a plasma. The laws governing the system have changed, but not in the direction of greater disorder, since it is exactly at this point that the self-ordering processes in a plasma occur. The high-energy regimes that occur as the final state of the amplitude instability are dominated by self-ordering effects. These self-ordering effects are not themselves the higher-order process; they are the key demonstration of the existence of that process.

It is not merely that the change in geometry indicates a change in the laws of the system, but that this change occurs in a specific, causal direction. The system becomes subject to (or mediates) a higher-order process that then goes on to govern the behavior of the system after the phase change.

The critical point about this transition is its lawful, non-determinist causality; to describe it requires an invariant that can account for the progressively higher-orderedness of such transitions at the same time that it allows a non-determinist causality. The identification and explanation of this invariant and its relationship to the phenomena occurring in any given system must become the principal focus of experimental investigation in science.

### Energy and the Future of Science

Even now there are some tantalizing glimpses of the solution to this problem, and the role of energy in the unfolding of the amplitude instability provides insight into the considerations involved. Energy, or more specifically, the rate of changes of energy density, is closely connected to an evolutionary invariant in all nonlinear physical systems. The problem is how to define an adequate concept of energy; the present concept of energy as a simple, homogeneous, scalar measure is insufficient.

There are several qualitative aspects of the current idea of energy, however, that are important; for example, any measurement of energy density in a system implicitly assumes a mode of evolution of the system. Temperature, the most common measure of energy density, can be rigorously specified only in an equilibrium system, and it is inseparable from the physics of equilibrium systems. Energy plays the same role in the case of the amplitude

instability; the modes of evolution of the orbits are inter-determined with the energy, but the role of energy is defined relative to the strength of the interaction (nonlinear coupling) between the orbits. Energy is more accurately defined as the capacity for self-ordering or self-differentiation in these systems. This kind of energy can then describe how laws of interaction can change. In other words, the present concept of energy is some kind of projection onto a scalar of this richer evolutionary quantification of an evolutionary invariant.

In a reductionist-based physics such a conception is impossible. Leibniz made the point very elegantly (and rigorously) when he noted that a universe run by Newtonian mechanics had to have a god to wind it up—and to keep winding it up.

I have made the same point here in different terms: Reductionism is inconsistent with the existence of a lawful universe. To go even further, the ideas from Riemannian geometry concerning the interrelation between non-reductionist singularities and fields, ideas that provide the tools for demonstrating the inadequacy of reductionist physics, also provide the key insights into the future directions science must take.

To begin the process of understanding the real universe requires a break with the reductionist underpinnings of modern physics and the undertaking of scientific work that incorporate three interconnected features:

(1) An adequate description of the single most striking qualitative feature of the universe—its self-organizing and self-differentiating evolution. In some fashion, this quality is the invariant for transition from one manifold to another.

(2) The appropriate geometry for any stage of this evolution. The kind of Riemannian geometry rich enough even in principle to support the kind of universe that exists has not yet been found.

(3) The mechanisms for transition from one geometry to another. This is undoubtedly the most difficult aspect of the problem: how to mirror in the physical world the non-determinist causality that is the essence of human creativity.

Steven Bardwell is the associate editor of Fusion magazine and director of plasma physics research for the Fusion Energy Foundation.

### References

- Henon, M. and Heiles, C. 1964. *Astron. J.*, 69:73.  
Klein, F. 1963. *On Riemann's Theory of Algebraic Functions and Their Integrals*. New York: Dover Publications.  
Lundford, G. H. and Ford, J. 1972. *J. Math. Phys.* 13:700.  
McGehee, R. 1974. *Invent. Math.* 27: 191.  
———. 1975. "Collinear Triple Collisions." In *Batelle Rencontres, 1974 Proceedings*, ed. J. Moser, New York: Springer.  
Parpart, U. 1976. "The Concept of the Transfinite." *The Campaigner* 9: 6.  
Vlasov, A. A. 1951. *Many Particle Theory and Its Applications to Plasma*. New York: Gordon and Breach (English translation, 1961).  
Waldvogel, J. 1976. *Celestial Mechanics*, 14: 287.  
———. 1976. "Triple Collisions." In *Long Time Prediction in Dynamics*, ed. V. Szebehely, Boston: D. Reidel.  
Walker, G. and Ford, J. 1969. *Phys. Rev.* 188: 416.

# The Origins Of Life

by Dr. Ned Rosinsky

RECENT FINDINGS IN the biological sciences have established that the origin of life must have occurred at least 500 million years earlier than any previous estimate, within several hundred million years after the formation of the planet.

This exceedingly rapid rate of early evolution cannot be explained on the basis of an accumulation of random chemical collisions or reactions or any of the other usual hypotheses based on the Second Law of Thermodynamics. Rather, early evolution must have depended on the strength of nonlinear modes of interaction as the driving force of the biosphere. The new findings also identify experimentally a critical mediating link in the development of the biological realm and thus provide an initial approach for investigating how early evolution could have proceeded so rapidly. Taken together, the results demonstrate that life is not an accident but the lawful product of the hylozoic or unifying quality of all matter and energy.

First, fossil evidence of bluegreen algae, which are primitive photosynthetic cells, was recently discovered by Dr. Elso Barghoorn of Harvard University in South African rocks dated at 3.4 billion years old, 1 billion years older than any other previous find. (The earth itself is dated at 4.6 billion years old.)

Second, scientists have mapped out a new evolutionary tree for both advanced and primitive organisms, based not on overall physical characteristics (morphology) nor on overall genetic content, but on the mode of expression of the genes. This work has focused on the part of the cell, the ribosomes, where proteins are produced according to the genetic code. According to Dr. Carl Woese from the University of Illinois, the scientist responsible for this mapping, it appears that the ribosome was a key bottle-

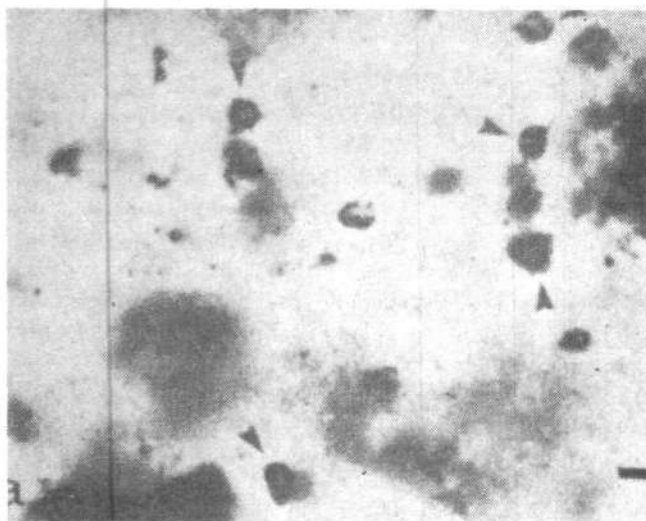

(a)



(b)

Shown in (a) are microscopic fossils of single-celled bluegreen algae found by Dr. Elso Barghoorn in rocks from Swaziland, South Africa that are dated at 3.5 billion years. The most convincing aspect of the find is the evidence of cell division in the fossil shown in (b).

Barghoorn's fossil discovery, announced in October 1977, follows years of searching for rocks formed earlier than previously discovered fossil records.

Source: The New York Times

## Evolution Is Self-Ordering

Using recent experimental results, Dr. Rosinsky demonstrates that life began much earlier than previously estimated and that early evolution was extremely rapid. In contradiction to theories that propose an undifferentiated "primordial soup" out of which life emerges as a result of a random selection of forms, the evidence presented here indicates that the basis of life is a tendency to higher levels of self-ordering. Early in evolution, three basic forms of life emerged. The evidence indicates these three forms are functionally defined by their genetic modes of expression — that is, by the differences in the chemistry of the cell's ribosomes, or more specifically the ribosomal RNA. These early life forms are the "trunks" from which further evolution unfolded.



Figure 1

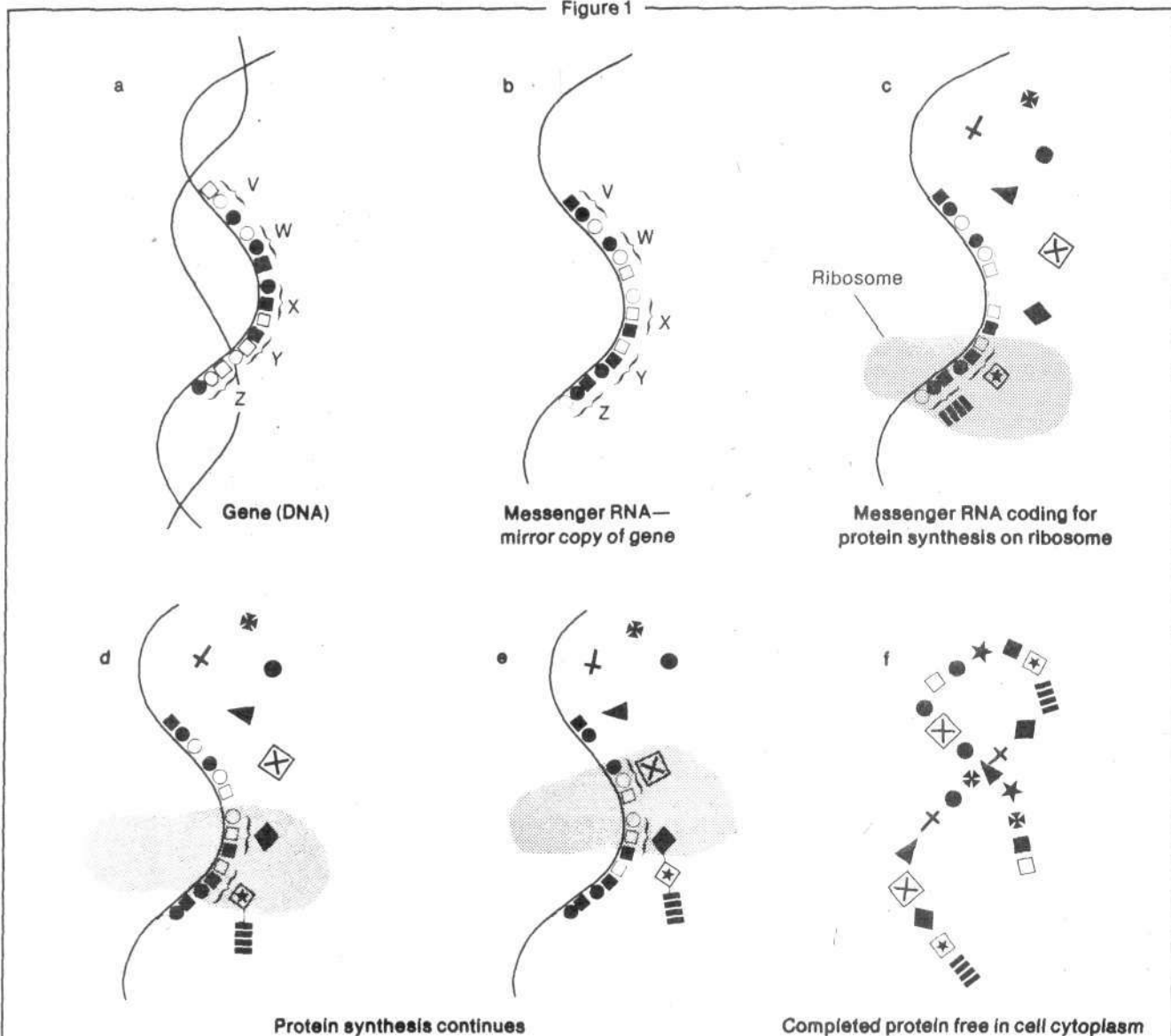

The directions for the production of specific proteins are encoded in the genes. In a, the gene is indicated schematically as a double-stranded helix, with five of the words of the code indicated by the letters V, W, X, Y, Z. [A gene for a protein generally contains 100 or more "words."] Each word is defined by the sequence of three DNA building blocks [nucleotides] of which it is composed. The building-block sequence within each of the words specifies which protein building blocks [amino acids] will be incorporated into the nascent protein.

A single strand of the double helix is transcribed, with a resultant messenger RNA molecule, which is a mirror copy of the DNA nucleotide sequence (b). The messenger RNA then travels to the cell's ribosomes, where protein synthesis takes place. In c the m-RNA is situated on the ribosome, while the amino acids, of which there are 20 different kinds, are brought in from the surrounding cytoplasm. Shown are two of the amino acids already joined together to begin the protein chain, specified by the words of the m-RNA. In d, more of the amino acids have been added as specified by the nucleotide sequence of the m-RNA. The completed protein, now free in the cytoplasm, is depicted in e. Although the protein was formed by a sequential addition of building blocks in a linear array, the molecule assumed a coiled and folded complex geometrical conformation.

The ribosome is at the center of the gene-protein translation process, accurately directing the synthesis of the protein specified by the DNA and mediated by an accurate, mirror-copy messenger RNA. Woese's work implies that breakthroughs in ribosomal functioning were central in establishing the several lines of primitive life forms that subsequently gave rise to advanced organisms.

neck in early evolution and that breakthroughs in ribosomal functioning are what established several primary evolutionary "trunks," or lines of primitive organisms, that were then the biological preconditions for all further evolution.\* Since the ribosomes provide the link between the genes and the functioning cell and, therefore, between the genes and the biosphere as a whole, they are a necessary precondition for the realization of negentropic gene-biosphere coupling.

Although the ribosomal components are themselves inherited through the genes, Woese's research demonstrates that not only are advances in ribosomal function to be considered metagenetic, or on a higher level, compared to other genetic changes, but that these metagenetic changes defined the course of early evolution.

Even more important, Woese's work demonstrates that the basis of the accelerating rates of evolution is the formation of *stable* functional molecular complexes. This directly contrasts with the more usual view that describes evolution as a *random* process where less stable formations allow for more rapid evolution. In short, the latter conception sees life as a complicated, statistically improbable mistake.

Given the Woese results, the notion that the genes are a blueprint for the developing organism and that evolution is based on random changes in this blueprint, along with natural selection, then becomes patently incorrect. Dr. Richard Pollak's report on the flax experiments\*\* indicating that genetic interactions with the biosphere are highly ordered, and the work under consideration here give an initial indication to a key link in the functioning of the gene-biosphere connection.

#### Woese's Research

Woese's research has consisted of isolating ribosomes from different species, analyzing them chemically, gridding the similarities and differences, and—under the assumption that the greater the similarity the closer the evolutionary distance—constructing a lineage of evolution, or evolutionary tree.

Woese used only one component of the ribosome, a segment of the ribosomal-RNA [r-RNA, not to be confused with the messenger-RNA that makes a faithful mirror-copy of the gene (DNA) and travels to the ribosome to use that copy to direct protein synthesis]. Schematically, the r-RNA can be represented as a linear array of thousands of molecular building blocks. There are four possible building blocks, designated A, C, G, and U, so that the number of possible r-RNAs is astronomical, on the order of 10 followed by 1,000 zeros.

Woese found, however, that the r-RNAs change slowly over long periods of evolution once they are established, and that the entirety of the different species he examined by chemically analyzing their r-RNA building-block sequence can be grouped in three main clumps, with none straddling the gaps between the clumps. He calls these three clumps the primary evolutionary branches, or *urkingdoms*, and follows their lines through all the major developments of advanced organisms.

The three urkingdoms are, first, a group consisting of the bacteria, the bluegreen algae, and the chloroplasts contained in the cells of green plants, which Woese calls eubacteria; second, a little-studied group of primitive single-celled organisms that feed on hydrogen and carbon dioxide and produce methane, and are therefore called methanogens; and third, the cell sap of cells of advanced organisms which contains a unique type of ribosome different from the bacteria and the methanogens; Woese classifies this group as cytoplasm.

This is not to imply that the three urkingdoms do not have a common ancestor or ancestor pool of organisms. All three urkingdoms have several basic qualities in common: All use DNA for the genes, and all use the same DNA-protein translation code. However, the point is that no such common ancestor is currently represented by any *existing* life form. Presumably, the lack of persistence of the more primitive forms was due to their lack of capacity for active incorporation within successive developments of the biosphere in comparison with the remarkable persistence—on the order of at least several billions of years—of the lines established by ribosomal developments.

With reference to the question of the extremely slow rate of change of the ribosomes, the notion of a "developed stability" that persists over a long period of time does not necessarily conflict with the idea of self-development as the invariant underlying evolution, but may in fact be a necessary precondition for mediating

\* George E. Fox, Carl Woese, et al. "Classification of Methanogenic Bacteria by 16 S Ribosomal RNA Characterization." *Proceedings of the National Academy of Sciences*, Vol. 74, No. 10 (October 1977); George E. Fox and Carl Woese. "Phylogenic Structure of the Prokaryotic Domain: The Primary Kingdoms." *Proceedings of the National Academy of Sciences*, Vol. 74, No. 11 (November 1977).

\*\*Richard Pollak. "Evolution—Beyond Darwin and Mendel." *FEF Newsletter*, Vol. 2, No. 4 (May 1977).

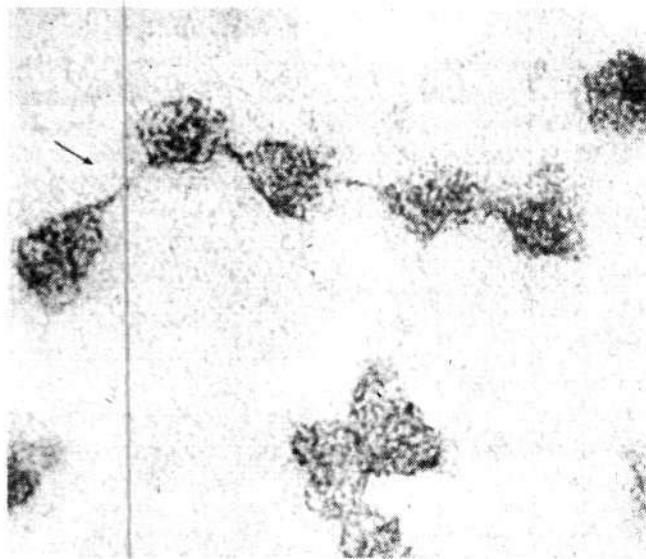

Electron microscope showing ribosomes attached to a messenger-RNA chain [arrow], that constitutes a polyribosome.

H. Slayter, *J. Mol. Biol.* 7: 652 (1963)

precisely such a process. Consider a hydrogen atom that was formerly in a molecule of water in the primitive ocean but now is in a complex human brain cell molecule. It is clearly not the same, but certain of its qualities have a remarkable persistence, and necessarily so for human development.

Aside from crossing over the usual two-kingdom classification of bacteria versus higher organisms, the Woese urkingdoms have further implications in light of the Barghoorn findings.

If the bacteria-bluegreens-chloroplast urkingdom, the *eubacteria*, had already differentiated into a separate blue-green line 3.4 billion years ago, then the originator of this urkingdom is older still, forcing the actual origin of life back still farther, to within the first few hundred million years of the formation of the earth. This is *much* sooner than any of the estimates based on the theory that life began as a cumulative result of *random* chemical reactions in a primitive ocean or "soup."

### The Basis of Life

The work on primitive chemical evolution by Fox, Ponnampertuma, Orgel, and others over the past two decades has generally followed along the line of a primordial soup theory. These investigators have shown that if mixtures simulating the presumed primitive atmosphere and ocean (methane, ammonia, water, and other compounds) are heated and exposed to electrical sparks and radiation presumed to mirror conditions in early evolution, then in a relatively short time these simple chemicals have been found to combine into complex amino acids, the building blocks of proteins. Further, that these molecular building blocks then combine to form actual primitive proteins, or proteinoids.

Similar but less conclusive experiments have produced nucleotides, the building blocks of the nucleic acids DNA and RNA, and have subsequently shown these also to combine to form primitive gene-like molecules. However, the work has been incorrectly presented and conceptualized from the standpoint of the First and Second Law of Thermodynamics; that is, that the molecules are "happier" in a combined state. Therefore, they are assumed to naturally combine while creating greater randomness in the rest of the environment, just as molecules of sugar will form a crystal from a sugar solution as the water evaporates.

The evidence in this article indicates that the basis of life is not randomness, but rather a tendency to higher levels of self-ordering. (The Fox and Ponnampertuma findings should be reevaluated from this perspective.)

### The Woese Hypothesis

Dr. Woese began his research at the University of Illinois with the hypothesis that a critical step in the early evolution of primitive organisms was the creation of an efficient and reliable process for the expression of genes. As the so-called stable carriers of inheritable traits such as eye color, each gene functions (or is expressed) by directing the synthesis of a specific protein in the cell. In

order to do this the genetic content, written in "code," must be "translated" by directing the formation of the appropriate protein according to the code. This translating process occurs on the ribosomes (Figure 1).

Woese reasoned that if the translation process were inefficient either in rate or in the reliability of the translation, then it would never be worthwhile for the organism to develop large genes and correspondingly larger and more complex proteins, to serve, for instance, as efficient enzymes to speed metabolic chemical reactions and thereby increase the energy available to the cell. If the translation were slow, then large proteins would simply take too much time. Worse, if the translation were inaccurate, then an entire protein might be rendered dysfunctional because of one small mistake in its production. Consider, as an analogy, the devastating effect of a 5 percent error rate in building a skyscraper compared to a similar error rate in building a wooden hut.

Woese concluded, therefore, that an early evolutionary breakthrough in ribosomal functioning would usher in an immense increase in evolution in general by establishing the precondition for stabilizing the gene-protein relationship. This relationship itself would be the necessary precondition for opening up potentials for increases in genome content (the total gene content of the cell), enzyme size and efficiency, and species proliferation—all of which are the necessary preconditions for an accelerating rate of evolution in the biosphere as a whole.

The ribosomes are located in the cell's cytoplasm, or cell sap. They are composed of several pieces of ribosomal RNA and many structural and enzymatic proteins. Woese gathered and isolated large amounts of ribosomes from a wide variety of organisms, separated out the r-RNA component of the ribosomes, and then determined the building-block sequence of the r-RNAs by partial chemical decomposition and analysis of the resulting fragments. He expressed the overlap of r-RNA fragments between organisms as a percentage and found that organisms *within* each of the three major urkingdoms have a 30 percent or more overlap, while organisms *between* urkingdoms have a 10 percent or less overlap.

Within each of the three urkingdoms the r-RNAs are much more homogeneous than many other aspects of the organism, such as their overall metabolic scheme. This led Woese to conclude that the r-RNA changes slowly with evolution compared to other cell functions, and is therefore a good indicator of long-range evolutionary connections.

For purposes of comparison with Woese's urkingdoms, the currently accepted phylogeny divides all organisms into two main groups based on cell type. One group, the *prokaryotes*, are all simple one-cell organisms that do not contain any membrane-bound organelles (structures in the cell that can be considered analogous to organs in an animal) and whose genes are free in the cytoplasm; that is, they are not contained in a cell nucleus. Typical of this group are the various kinds of bacteria.

The second group, the *eucaryotes*, has much larger cells, each typically containing 10,000 times the volume of

Figure 2

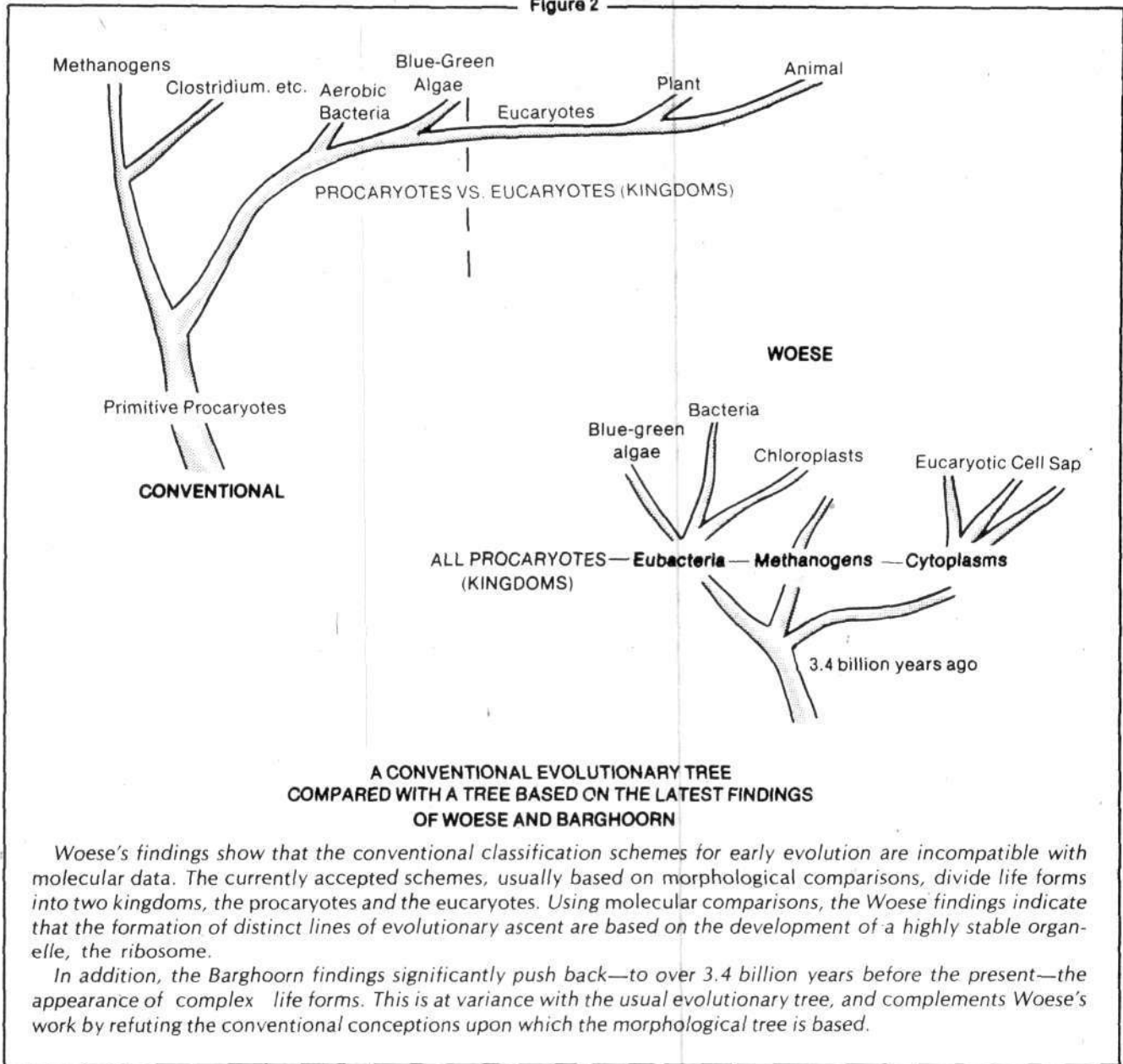

A CONVENTIONAL EVOLUTIONARY TREE  
 COMPARED WITH A TREE BASED ON THE LATEST FINDINGS  
 OF WOESE AND BARGHOORN

Woese's findings show that the conventional classification schemes for early evolution are incompatible with molecular data. The currently accepted schemes, usually based on morphological comparisons, divide life forms into two kingdoms, the procaryotes and the eucaryotes. Using molecular comparisons, the Woese findings indicate that the formation of distinct lines of evolutionary ascent are based on the development of a highly stable organelle, the ribosome.

In addition, the Barghoorn findings significantly push back—to over 3.4 billion years before the present—the appearance of complex life forms. This is at variance with the usual evolutionary tree, and complements Woese's work by refuting the conventional conceptions upon which the morphological tree is based.

a procaryotic cell and a correspondingly larger energy throughput. In addition to large single-celled organisms the eucaryotes include all of the multicellular or higher organisms.

These two main groups are termed kingdoms, with the higher organisms then divided into the plant and animal subkingdoms. All eucaryotic cells have a nucleus that contains the genes and, generally, numerous membrane-bound organelles such as the photosynthetic chloroplasts in plants and the mitochondria that engage in energy-producing reactions in both plants and animals.

One of the key questions evolutionary biologists have not been able to explain is the huge jump between the procaryotic and eucaryotic kingdoms.

In contrast to this commonly accepted scheme, Woese's three primary evolutionary lines are all procaryotic. The first group includes the broad class of bacteria, the bluegreen algae, and the chloroplast organelles of green plants. Woese terms this grouping the eubacteria (although it includes the bluegreen algae which biologists generally admit don't fit neatly into either of the usual kingdoms, since the cells are small and without a nucleus but contain a highly organized photosynthetic apparatus). It also includes chloroplasts from eucaryote cells, which have their own r-RNAs. These are unmistakably similar to the bacterial r-RNAs. This organelle bears other distinct similarities to bacteria, which will be discussed below. (See Figure 2.)

Woese's second urkingdom consists of a little-studied group of primitive single-cell organisms that feed on hydrogen and carbon dioxide and produce methane, the methanogens. These organisms are strict anaerobes, that is, they cannot live in the presence of oxygen, and their hydrogen-carbon dioxide metabolism has an extremely low energy yield. The methanogens' need for hydrogen and intolerance for oxygen restricts their growth to extremely remote areas, such as ocean bottoms, swamps and sewage dumps, and underground hot springs. Aside from their inaccessibility within the ecology, they are poorly studied because they are difficult to grow in the laboratory.

The methanogens have been previously lumped together with the bacteria because of their simple cellular structure, but Woese's work shows that they have a markedly different r-RNA, in addition to their unique energy metabolism. They have other unique features, such as the composition of their cell wall, which is different from the eubacteria, and which tends to support Woese's classification. Thus far only several dozen species have been isolated, but new species are readily found when they are searched for.

The third major group of r-RNAs is found in the ribosomes present in the cytoplasm of eucaryotic cells, that is, in the cell sap rather than within the organelles. Thus Woese considers the general cell body constituents to be on an evolutionary par with the cell's organelles. Interestingly, the r-RNA from another major type of organelle, the mitochondria, is markedly different from all of the above three types. Woese does not as yet regard the mitochondria as representative of a fourth kingdom since there have been no free-living cells yet found that contain similar r-RNA, but this may well represent just such a fourth line. This would not be inconsistent with Woese's general hypothesis. He not only allows for the possibility that as more species are tested more urkingdoms may be found, but regards it as likely that numerous other urkingdoms have evolved and since become extinct.

Woese summarizes his results as follows:

All living systems appear to stem from at least three aboriginal lines of descent, represented now by three distinct phylogenetic groupings, or *urkingdoms*. These are: (1) the typical bacteria, or *eubacteria*; (2) the methanogenic organisms; and (3) the group now represented by the "cytoplasmic component" of eucaryotic cells.

What remains to be resolved is the relative time sequence and the mode of interaction of the three *urkingdoms*.

Before discussing the time sequence, it should be pointed out that an even more basic question is what did life look like before the procaryotes? What were the genes? Were there any primitive ribosomes? If there was inaccurate translation, were there distinct species as we now know them? Were the genes and ribosomes always present together, or did they arise at a later stage of evolution?

Especially intriguing is the presence of RNA in the ribosome. Could this represent the self-differentiation of

earlier genes to permit the organism to function at a higher level, or was this always a separate function of separate nucleic acids? These questions cannot be answered now because we have no direct evidence from this period of evolution. However, the actual functioning of the ribosome must be approached from the perspective of its lawful original development, as well as the further evolution which it then made possible.

Returning to the *urkingdoms*, several questions immediately arise from this evolutionary scheme. First, what does this eucaryotic cell represent in evolution? Woese regards the eucaryotes as having arisen from *communities of procaryotes*, the next major stage of evolution following the evolution of the procaryotes themselves. In this view not only are the chloroplasts, mitochondria, and other organelles regarded as representatives of previously free-living forms, but so is the cytoplasmic component of the cell. Thus although most of the discussion in this article has focused on the self-reflexive lawfulness of the procaryotes, we can now get a glimpse of what enormous further potentials the differentiation of the procaryotes sets up.

The notion that the eucaryotes arose from procaryotic communities is not new, since biologists have long noticed that the eucaryotic organelles have many procaryotic characteristics such as their own DNA, their own surrounding membrane, and the capacity for their own self-replication. Woese's evidence adds strength to this hypothesis by demonstrating the bacteria-chloroplast connection, and, in particular, by implying that the cytoplasm of eucaryotes represents a previous procaryotic line. "All phylogeny stems from procaryote phylogeny," Woese concludes.

The second question is where does the complex eucaryotic nucleus come from? The eucaryotic genes within the nucleus are arranged on chromosomes, whose size and complexity is orders of magnitude greater than procaryotic genomes. Woese's work does not approach this problem, but its solution is clearly key to understanding the development of the eucaryotes.

### The Time Component

Taken on its own, the r-RNA data per se are only general indicators of evolutionary patterns, without any time component. Woese attempts to resolve this problem as follows. First, he notes that the ribosomes are extremely stable over evolution. His data indicate that the degree of building-block sequence overlap among r-RNAs within each *urkingdom* is 30 to 70 percent, while between the *urkingdoms* it is only 10 percent or less (the r-RNA contains several thousand building blocks per molecule).

Woese also notes that there is no clear indication that the changes that have occurred *within* the *urkingdom* have had much functional significance. For instance, if the several r-RNA components of various species' ribosomes from the eubacteria *urkingdom* are separated and then recombined across species within that *urkingdom*, there is no appreciable loss of cellular function. Woese makes the assumption, that therefore, when the rare changes do

occur in the r-RNA, they occur regularly with respect to time. He thereby generates at least a relative time metric; that is, within any urkingdom the time distance from a common ancestor for any two species is proportional to the difference in overlap of the r-RNAs.

Woese then points out, in conjunction with the Barghoorn findings, that the r-RNA divergence within the eubacteria urkingdom between the bluegreen algae and the bacteria is quantitatively on a par with divergences within both the methanogens and the cytoplasm, implying that these lineages may also date from the first billion years of the earth's existence.

However, if it is necessary to go back more than 3.4 billion years to trace the ancestors of the eubacteria with their small degree of r-RNA divergence, then there is not enough time in the history of the earth to trace the wider divergence between urkingdoms, so the time linearity assumption breaks down. There are then two general possibilities open. Either the three urkingdoms evolved in a coeval fashion from a common ancestor, or they evolved at different periods of the evolution of the biosphere within the time frame of several hundred millions to a billion years.

On the face of it, separate origins of the urkingdoms from more primitive life forms would seem impossible; an advance as fundamental as an improved ribosome seemingly would usher in such an avalanche of evolutionary potentials that any further advance would have to spring from that line of development.

But consider the late Mesozoic catastrophe, in which the dinosaurs, the dominant species, vanished, while the smaller mammals became hegemonic. In order to explain this, the invariant of evolution must be located outside of any one species, in the development of the biosphere as a whole.

#### Metabolism and Early Evolution

Although the Barghoorn findings and the r-RNA divergence patterns indicate a general time framework for the urkingdom evolution, the specifics of metabolism and energy throughput of the urkingdoms go further in suggesting an evolutionary sequence. The data here are not as clear as in the r-RNA determination of the urkingdoms, but the implications are an important guide to further research.

By most current theories of early geology the early atmosphere was composed of hydrogen, hydrogen sulfide, carbon dioxide, ammonia, and water, the gases spewed out by early volcanic activity. At some point, through the activity of evolved photosynthetic organisms, this chemically reducing-type atmosphere was changed to an oxidizing atmosphere composed of oxygen and nitrogen via the photosynthetic reaction of carbon dioxide and water to produce carbohydrate and oxygen, creating the kind of atmosphere in which we currently live.

Now, what relation does this bear to the kinds of metabolisms found in the urkingdoms? The methanogens must have hydrogen to live, using it to chemically reduce carbon dioxide, although some of the species can substitute other substances for the carbon dioxide. They

probably arose, therefore, at a time of abundance of hydrogen in the atmosphere, while the atmosphere was primarily a reducing atmosphere. This means they probably arose very soon after the formation of the earth. Their low energy throughput, based on the hydrogen-carbon dioxide reaction, also strongly argues for an early evolution.

On the other hand, the bluegreen algae and the bacteria, even those bacteria that live in anaerobic conditions, have energy throughputs orders of magnitude higher than the methanogens. In addition, these organisms cannot metabolize hydrogen. Therefore, if current species are dependable representatives of their ancestors in this respect, the eubacteria evolved later than the methanogens. The situation is less clear with the cytoplasm, since there are no separate free-living cytoplasm available for the study of their metabolism. Eucaryotic organisms are usually aerobic, that is, they must have oxygen to live, so they probably evolved late. Also, their energy throughput, even the single-cell eucaryotes, is thousands of times or more greater than the procaryotes.

At the time of the evolution of the methanogens, could they have been the dominant life form? "Probably not," according to Woese:

The methanogens, at least currently, are not producers of net energy gain for the biosphere; they live off compounds which already contain energy. I can't believe that evolution ever went through a scavenger period with primitive organisms feeding on the detritus from a pre-biologic phase of evolution. There must have been primitive photosynthesis, some form of energy capture, from the time of the earliest life forms. This would also close the carbon cycle with an organism like the methanogens creating an interdependent ecology.

If the methanogens were the first of the currently existing urkingdoms to have evolved, it is very possible that other organisms arose simultaneously with photosynthetic capacities, each as the necessary precondition for the other's existence, with the ecological function of one being so different from the complementary function of the other that the two evolved very different basic metabolic activities and metabolic apparatuses. Conceivably, if such a pair of groups existed, only the methanogens are left now, or the other groups will be found if they are searched for.

Clearly, much more empirical data are needed to fill out any such notion as well as to resolve the other indicated questions. However, with the Barghoorn and Woese findings we have taken a major step in understanding the interactions responsible for the biosphere's two remarkable properties: accurate reproduction and negentropic development.

*Ned Rösinsky, a practicing physician, is a member of the biological sciences division of the FEF.*

# Superconducting Transmission —

by Marsha Freeman

AS ANYONE who has experienced a power blackout or brownout knows, there is no possibility that the United States can grow with its current power grid. The system cannot adequately handle the electricity used now, let alone carry the nation into a fusion-based economy of the 1990s, where energy consumption would increase exponentially.

The major problems are that conventional generators will soon reach the limit of power generation that current transmission materials can withstand, and that 10 percent of the power transmitted now is lost as heat—a loss consumers can ill afford. We have at hand the technology to solve both problems and to lead us into the 21st-century—*superconductivity*.

Superconducting transmission lines, kept supercold by liquid helium, could easily meet expanded energy needs at half the cost of conventional underground transmission lines. The 1973 and 1975 feasibility studies of superconducting transmission, carried out by the Brookhaven National Laboratory, make it clear that the only thing preventing a transition to low-cost high-technology

commercial power transmission is the Department of Energy's refusal to fund the necessary research and development projects. Like the deliberate sabotage of fusion research, this zero-growth approach to energy guarantees that the U.S. will not have the electrical power necessary for a leading industrial nation.

## The Current Grid

Electric power lines were first strung above ground because costly infrastructure was not required and resistive heat could be dissipated directly into the air. As urban areas became more densely populated, high voltage lines were buried underground; nevertheless, fewer than one percent of the 250,000 miles of existing transmission lines in the U.S. are now underground.

The problem with underground lines is not only the cost for tunneling and infrastructure. The density and insulation quality of the ground surrounding the lines result in lower limits for power transmitted underground than above ground. High pressure, oil-filled underground cables carry less than 1,000 megavolt-amperes (MVA, used to indicate the amount of power produced at the source), and the more advanced system of compressed gas insulation brings the limit up to only 6,000 MVA, compared to the estimated 7,000 MVA limit of overhead lines.

In the not-too-distant future, these transmission lines must be capable of delivering more than 7,000 MVA, *without* the 10 percent loss of potential delivered power (measured in megawatts, MW) that now occurs via resistive heating.

Superconducting transmission lines can meet these requirements because the lines involve virtually no loss from resistive heating and tap a greater percentage of the total energy available for useful work. Even at today's paltry level of available superconducting technology, it is estimated that a superconducting underground line could carry up to 10,000 MVA—or near 10 gigawatts of power.

In theoretical terms—not from an engineering standpoint—this would mean that all of the electrical power for New York City could be supplied through one line, and this line would be smaller than a conventional cable because the density of power in the material is higher.

*Brookhaven National Laboratory is investigating both the rigid cryogenic pipe [at left] and the flexible cable [at right] for superconducting electrical transmission.*

ERDA

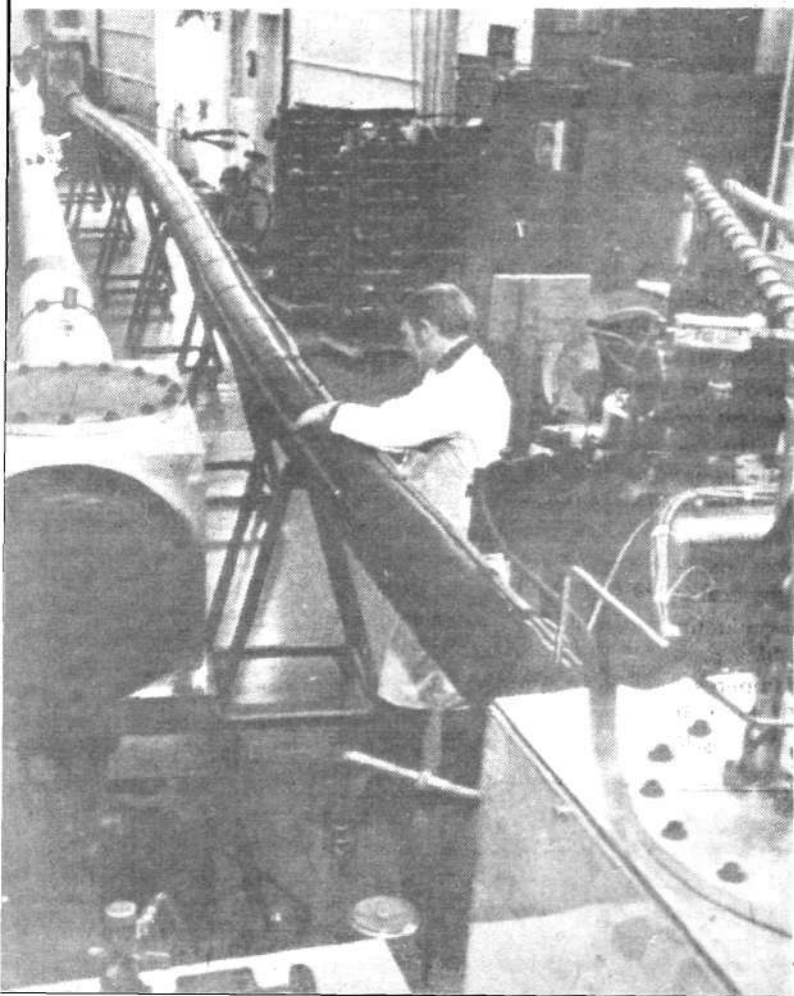

# More Power at Half the Cost

The development of commercial superconducting transmission will have to go hand-in-hand with the commercial development of magnetohydrodynamics. To take one technical example, if alternating current, ac, is transmitted through superconducting cables, there is a very small amount of heat loss due to *hysteresis*—the loss that occurs from the changes in magnetic and electrical flux as the current alternates direction. (ac is the type of current now produced by conventional fossil fuel and nuclear steam cycle generators and used in most homes and industry.)

Magnetohydrodynamic direct conversion of heat to energy—either the fossil MHD system which will be ready for commercialization within the next few years or direct MHD conversion with fusion energy—will make direct current (dc) available from the power plant for transmission at distances greater than 150-200 miles through the nation's integrated electrical grid. The costs for dc conversion to ac will be more than compensated for by the near elimination of the hysteresis loss typical in ac transmission.

## Technical Feasibility

The only real operating cost for a superconducting transmission system is the energy cost to keep it supercold, particularly in the case of ac transmission, because the underground system is affected by ambient heat from the earth. The problem involves all phases of materials research and development, and is definitely within close reach.

The specific heat capacity of various superconducting alloy metals changes significantly with temperature. It takes much more energy to remove one degree of temperature from a liquid helium coolant at 4 degrees Kelvin (4 degrees from absolute zero) than it does at 20 degrees Kelvin, for example.

Scientists have been experimenting with variations in metal alloys to bring the critical temperature limit at which the material loses its superconductivity up as high as possible. Niobium-titanium is the most commonly used material. It is relatively easy to fabricate, but its transition temperature is 4.2 degrees Kelvin. Niobium-germanium and other alloys have a high transition temperature but they are very brittle and inappropriate for large-scale use.

More advanced techniques for extruded fabrication would make these more advanced alloys available for commercial cable at a lower cost for cooling. This could eventually lead to the use of liquid hydrogen as a coolant rather than the more expensive liquid helium.

Another factor of feasibility is the design of an insulation system—a *cryogenic envelope*—for the cable to prevent heat leaks from the ambient surroundings. Some of the most exciting work in this area has been done by Brookhaven National Laboratory in New York.

A study done by the lab in 1973 for New York's Long Island Lighting Company, LILCO, showed that over 50 percent of the materials cost of the entire system was required for the cryogenic envelope. This led researchers to take a second look at the design. By 1975, when a second feasibility study was done for a group of utilities in Pennsylvania, Brookhaven had redesigned the insulation

## What Is Superconductivity?

The phenomenon of superconductivity was discovered by Kamerlingh Onnes at the University of Leiden in Holland. In 1908 Onnes succeeded in liquifying helium by achieving for the first time a temperature of 4.2 degrees Kelvin. (Zero degrees Kelvin is the absolute zero of temperature, the point where all molecular motion ceases.) Until that time, 20.3 degrees Kelvin, the boiling point of hydrogen, was the lowest temperature ever maintained experimentally.

Three years later Onnes discovered superconductivity while exploring how far the resistivity to the flow of an electrical current of a pure metal would drop as the temperature dropped. He found that materials brought down to 4.2 degrees Kelvin exhibited *no* resistance to electric current; the current, once established, would continue to flow completely unimpeded. Furthermore, the flow appeared capable of persisting forever; no resistance meant no loss of energy!

The importance of the discovery of superconductivity can be seen from the following comparison. A conventional 12-gauge copper wire cannot carry a current greater than 20 amperes because the resistance creates heat that would melt the copper wire. A comparable wire made of superconducting materials, such as the niobium-titanium alloy presently used, can carry a current of 50,000 amperes, with no significant resistive loss or heating if kept at the temperature of liquid helium (4.2 degrees Kelvin).



system by simplifying the structure, significantly lowering the cost of installing the envelope.

### Economic Feasibility

It is most instructive to examine the results of the 1973 Brookhaven study in terms of cost.

Assuming that LILCO's two nuclear plants will be completed on its original 15-year schedule, approximately 4,800 MW of power would have to be transmitted. The table compares the cost of constructing a conventional underground system to a superconducting underground system. (The only way LILCO could hope to avoid a massive power failure like the one that followed the Winter 1978 ice storm is to put their above-ground cables underground.)

Even with the cost of the cryogenic envelope, the figures speak for themselves. Compared to the conventional nine circuits, only two are necessary for the high-power-density superconducting lines. The reactive compensation required for the conventional system is a measure of the power lost through resistive heating and is not applicable in any significant degree to the superconducting system.

The energy required to run the system, as a percentage of the total carried, is clearly more than triple for the conventional system; the number of circuit breakers is simply a function of the number of circuits used.

The superconducting system, studied here for the first time in actual commercial parameters, comes out at *one half* the cost of a conventional underground system. In the 1975 Pennsylvania study, the improved design of the cryogenic envelope and the trade-off between lowering the initial capital investment cost and slightly raising the operating cost, brought the superconducting system's figure to below \$990 per megawatt mile.

Once the technology is commercially introduced, the

day to day testing of the system would not only improve its design but lower its cost as the engineering questions of reliability, cryogenic subsystems, and overall performance were solved. Cable fabrication, now a handicraft pursued by gifted scientists, would become a mass production industry.

### Unfreezing the Funding

A joint program in superconducting transmission is part of the U.S.-Soviet Union energy technology agreements signed by President Nixon in 1972. The Soviets have taken this program more seriously than the U.S. where the only dc development work being done is at Los Alamos Laboratory in connection with military applications. The Soviets already have a small section of superconducting cable in their Moscow power grid demonstrating that the cable can function under commercial conditions.

The situation is similar to that of the current U.S. fusion effort, which abounds in theoretical and technological breakthroughs but has been relegated by the Department of Energy to such low funding levels that commercial application becomes possible only at some indeterminate future date, and military application research remains limited and top secret.

With all the concern in Washington these days over energy efficiency, environmental safety, and pollution, superconducting transmission line development should certainly be at the top of the funding list. As for the debate over how to meet the nation's future energy needs, the only answer is to develop and use all available and new technologies—from the supercold regimes of superconductivity to the high temperature regimes of plasma physics.

Marsha Freeman heads the industrial research division of the Fusion Energy Foundation.

COST COMPARISON OF SUPERCONDUCTING AND CONVENTIONAL TRANSMISSION—BROOKHAVEN STUDY OF LILCO

Transmission	Superconducting	Conventional
Number of circuits	2	9
<b>Costs</b>		
Installed cost of system	\$189,800,000*	\$344,200,000
Reactive compensation	---	24,200,000
Capitalized energy and maintenance	13,000,000	42,000,000
Required circuit breakers	6,000,000	11,200,000
Total installed cost	208,800,000	421,600,000
Total MVA normal load	4,800MVA	4,800MVA
Cost per MVA Mile	\$1.020	\$2.070

\*In 1973 dollars.

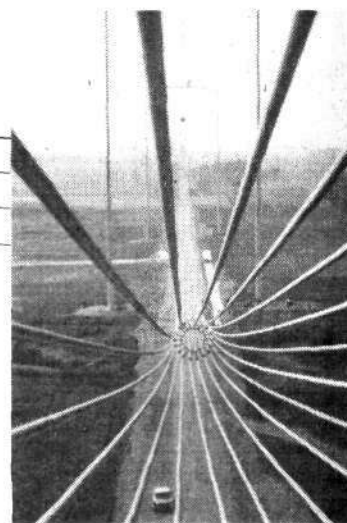

# Jean Paul Marat

## *The Terrorist Model For Today's Antiscience Environmentalists*

by Claude Jouvenal  
and Dr. Morris Levitt

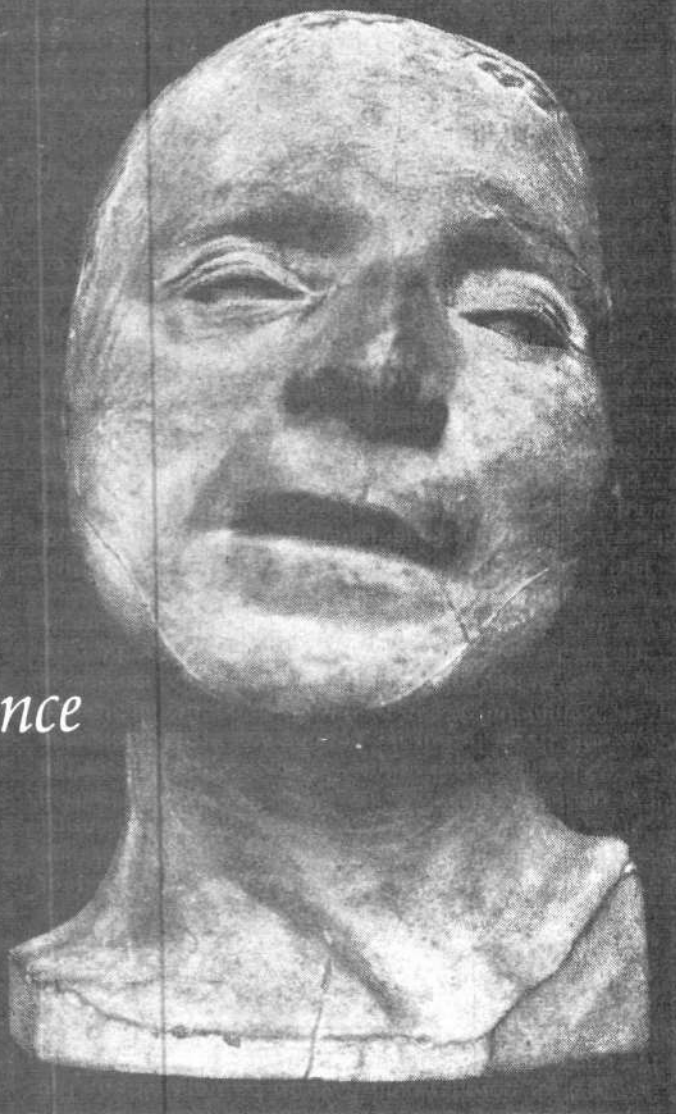

WHILE THE BLOODTHIRSTY Jean Paul Marat is recognized as one of the leading initiators of the Great Terror of the French Revolution, one fact of crucial significance is generally overlooked: a single, overriding target for destruction was the French Academy of Sciences. This, more than any other fact, clearly establishes the scabrous Marat in the lineage of the anti-science British Royal Society.

The red-capped Marat is appropriately the patron saint of the hordes of environmentalist terrorists rampaging in the United States and Western Europe against nuclear power, technology, and science. Like the environmentalist mentors—Barry Commoner, Ralph Nader, Noam Chomsky—Marat was a quack, a charlatan who was spurned by the French Academy of Sciences and ridiculed by the great scientist Benjamin Franklin. And like the environmentalist controllers of today, Marat was a bred and groomed agent of British intelligence.

Marat's criminal record against science was documented in the 1960 book by Joseph Fayet, *La Revolution Francaise et la Science* [1789-1795], written under the sponsorship of the prestigious French National Scientific Research Center. Fayet documents that Marat justified his criminal activities by declaring in March 1793: "At the outbreak of the Revolution, wearied by the persecutions that I had experienced for so long a time at the hands of the Academy of Sciences, I eagerly embraced the occasion that presented itself of defeating my oppression and attaining my position." Marat's crusade against the Academy was no mere personal vendetta, however, but a key part of the plan of Britain's Guelph monarchy to destroy France.

Throughout the 18th century, the Academy of Sciences was the central institution for the continuation of the French Colbertiste tendency. Since midcentury, the scientists grouped in the academy—the Trudaines, Lavoisier, Turgot, Euler, Lagrange, Berthollet, and

others—had combined their scientific activities with government posts and had forged an industrial policy that made France—not England—the leading industrial nation in Europe.

The outlook of these collaborators of Franklin was *republican*: the education of France's working population and degraded peasantry with a national policy centered on upgrading the labor force through industrialization and the introduction of scientific agriculture. England's plans for monetarist worldwide domination could be achieved only by breaking France as an industrial and political power. To do that, the Academy of Sciences had to be discredited and dismantled. That was the job of the scratching *l'ami du peuple*.

### The Ignoble Savage

Marat's touchstone was Jean-Jacques Rousseau, the protégé of David Hume whose *Discourse on Inequality* claimed that scientific and material progress had destroyed man's real nature. Marat, who called Rousseau the greatest man of the century, was Jean Jacque's primitive savage unleashed.

Like Rousseau, Marat was of Swiss origin. Born in the Swiss city of Neufchatel in 1743, Marat came to Paris when he was 17 years old and attempted to introduce his "prise" into the ongoing encyclopedia project. One of the editors, the mathematician d'Alembert, rejected it without hesitation.

To improve his fortunes, Marat, like Voltaire before him, traveled to England in 1766, where he remained for 11 years. It is likely that Marat was scouted and recruited to British intelligence circles during his travels to Scotland, before he settled in London. Nothing is known of his first years abroad, except that after a few years he suddenly emerged in the highest of British society, with his quarters in Soho, the aristocratic section of London, where he enjoyed a reputation as a writer and a medical doctor. His medical credentials consisted of a degree of doctor of medicine from St. Andrews University in Scotland, an honorary title for which no exam was required! (Recall the current case of Anglo-American so-called physicist Amory Lovins, the recent no-degree Friends of the Earth export from Cambridge University who is leading the soft-energy bandwagon here.)

Back in Paris in 1777, "Dr." Marat gave his social status a further boost by claiming to be from a noble line of Spanish counts, whereupon he was appointed doctor for the Count of Artois's stables. Rising rapidly in the world of veterinary medicine, Marat was soon appointed doctor of the count's bodyguards.

During this same period, Marat launched his infiltration and subversion operation against the Academy of Sciences, beginning by inviting the Academy to attend his experiments with a "solar microscope" (but trying in vain to keep Lavoisier out of the visiting delegation). Rejected again by the Academy, Marat published a book in 1780 on his experiments on light in which he attacked Newton. Soon, enthusiastic letters of support appeared in the *Journal of Literature, Science, and Arts*; author Fayet,

however, shows these all to be forgeries from the pen of Marat.

Having established this nationalist cover, Marat opened up an attack in 1782 on Franklin's theory of electricity, arguing that electricity and magnetism are totally different phenomena, requiring different "fluids." At the same time, Marat tried on numerous occasions to get Franklin to give some sign of approval to his scientific efforts. Apparently not in the least taken in by these tactics, Franklin took advantage of an invitation to one of Marat's experiments to pull a useful stunt. When Marat brought forth a crystal ball and proceeded to produce emanations of smoke by some alleged electrical reaction, Franklin volunteered to make the experiment even more striking. He placed his own head in the place of the crystal ball before Marat could remove the source of smoke and let the smoke rise from his head, to the great delight of the audience.

Returning full cycle on the Newton caper, Marat next manipulated d'Artois's secretary-interpreter Beauzee, a member of the Academy of Sciences, into having the Academy publish an anonymous translation (dedicated to the king) by Marat of Newton's *Optics*. The only catch was that Marat had purposely mistranslated Newton to have him say the opposite of the intent of the original text. One day after the publication, Marat himself revealed his trick discrediting the Academy and also revealing that this had been his main object all along.

In a last effort to aggrandize his position, Marat sought to become the head of the Madrid Academy of Science, which was then in formation. Several Spanish and French agents attempted to promote him within Spanish royal circles. Marat even went so far as to completely reverse his former anti-Catholic position and to strenuously assure the Spanish court of the depth of his Catholic faith. Fortunately, reliable scientific circles managed to get sufficient compromising information on his career to the Spanish king in time to squelch the appointment.

### 1789: New Opportunity

With the social crisis in France rising and visible by 1788, Marat began the public political campaign against the "privileged position" of the Academy of Sciences that he had been hatching for years. After the mob was unleashed against the Bastille by British direction, anonymous pamphlets and decrees proliferated against the scientific academies as "instruments of royal tyranny." In 1790, while the finance committee of the first revolutionary government deliberated on the continued funding of the scientific academies, Marat published his pamphlet, "The Modern Quacks," which he had written years before in expectation of the unleashing of the rabble.

By 1791, Marat was emboldened specifically to target Lavoisier, then treasurer of the Academy, and to attack the National Assembly for not having yet destroyed all the academies, which he brazenly accused of embezzling funds.

Alarmed, Father Morellet, a close friend of Franklin and director of the Academy, wrote to Britain's Lord Shelburne—unknown to many French as one of the group

of Marat's controllers—that "the agitation of the minds" was reaching a peak. Lavoisier, meanwhile, notified Franklin that "circumstances have led us too far." All that was left to set up the scientists and their institutions for destruction was to unleash the "counterculture" pornographers of the Royal Academy of Painting and Sculpture under David to join the black propagandists in enflaming the street mob.

By 1792-93, outright terror was unleashed against academic circles. They were denounced as the "aristocracy of knowledge," who must be prosecuted as vigorously as the aristocracy of birth according to the "Law of the Suspects" passed in 1793. In the same year, the academies were shut down, disrupting projects vital to the strategic military and economic interests of the Republic, such as the standardization of the meter nationally and development of new methods of gunpowder and steel production.

The eminent astronomer Bailly, mayor of Paris, was butchered. The Duke of La Rouchefoucauld, Franklin's secretary in France, who was described by the great republican leader Condorcet as "a true friend of liberty," was lynched by the mob on the way to the guillotine. Monge, the future driving force of French scientific education and a staunch Jacobin, was almost rounded up as an "émigré" and for being too indulgent to nobles in the navy. The final act was the execution of Lavoisier, the central figure of the Franklin-Turgot scientific-industrial networks. Lavoisier was murdered at the guillotine after a vicious step-by-step process of closing off his scientific work and associations to create maximum terror and to splinter the scientific community.

### The British Model

With more or less of the ingredient of violence, the Marat operation is exactly the form of the anarcho-Jacobin events that British intelligence staged in France during spring 1968, especially against "capitalist science" at the Faculté des Sciences. It was also the modus operandi of the so-called Great Cultural Revolution in Maoist China, and it is the same antiscientific filth systematically injected into the United States since the 1960s.

Almost the identical pseudorevolutionary wrecking operation was run in the late 1920s by probable British agent Bukharin to "purify" the Soviet Academy of Sciences (of noncommunists). Bukharin's purge displaced the Academy's preeminent leader for coupled industrial-scientific development, Academician Vernadsky, in favor of "dialectical materialist" hacks like Bukharin and Riazanov.

From a longer historical standpoint, Marat's project did not succeed. In 1793 Charlotte Corday struck the blow that ended his treachery. And a year later, the humanist scientific networks under the leadership of Gaspard Monge and Lazare Carnot regrouped and drafted the plans that led in 1795 to the world's most advanced republican-scientific cadre training and research institution, the Ecole Polytechnique. This inspired similar developments in Germany (Humboldt, Liebig) and the United States (West

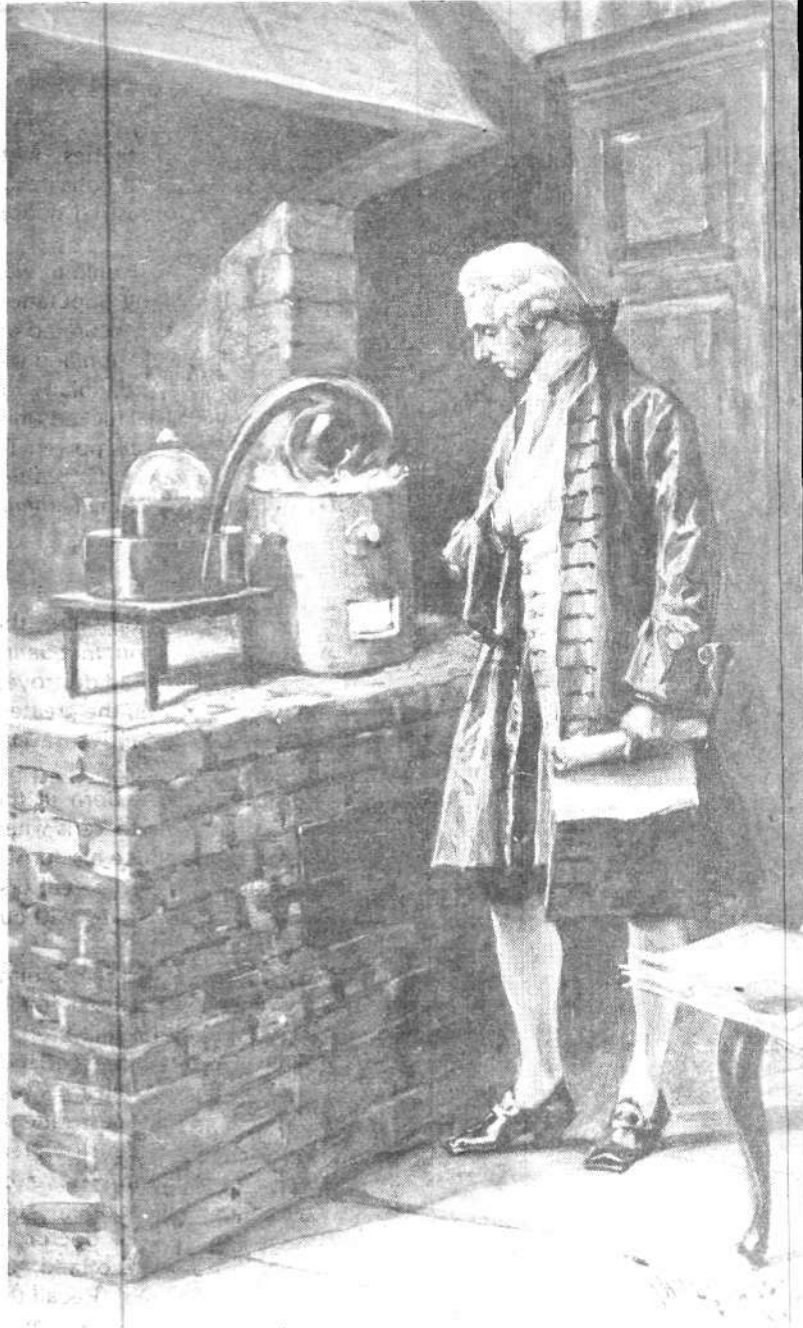

*Lavoisier in his laboratory*

Point), and ultimately produced in France the great Pasteur.

The evil legacy of Marat and his British superiors, however, is now subverting the will of humanist capitalist and socialist forces alike to get on with the vital business of mutually developing the globe. Therefore, the following question is more than academic: Would you now tolerate the stupidity of simply labeling butcher Marat as "inconsistent" or "too ideological"? If not, then why do you tolerate the Marats of today?

Claude Jouvencel is a Paris collaborator of the Fusion Energy Foundation; Morris Levitt is the executive director of the FEF.

## Research

# Japan's Fusion Program Growing Rapidly

The total resources invested in the Japanese fusion effort will exceed the U.S. program within two years, at current growth rates—unless the U.S. Department of Energy reverses its zero-growth policy for fusion research.

The phenomenal growth of the Japanese fusion program was reported last month by Dr. T.K. Fowler, associate director for magnetic fusion research of the Lawrence Livermore Laboratory, following his trip to Japanese fusion labs earlier this year.

"The Japanese government is making a major commitment to fusion research," Fowler said. "Annual funding, now at about \$100 million, has increased about 25-fold in six years and many new projects have been initiated including the JT-60 tokamak, at \$600-700 million."

Although this government funding level is less than one-quarter of what the U.S. government is devoting to fusion research, the total Japanese fusion effort amounts to about one-half that of the U.S. when private funds are included. Unlike its U.S. counterpart, Japanese industry is investing substantial private funds and resources to develop fusion power reactors within 15 years.

Dr. Fowler pointed out: "Interaction with industry is another strong point. Major industries such as

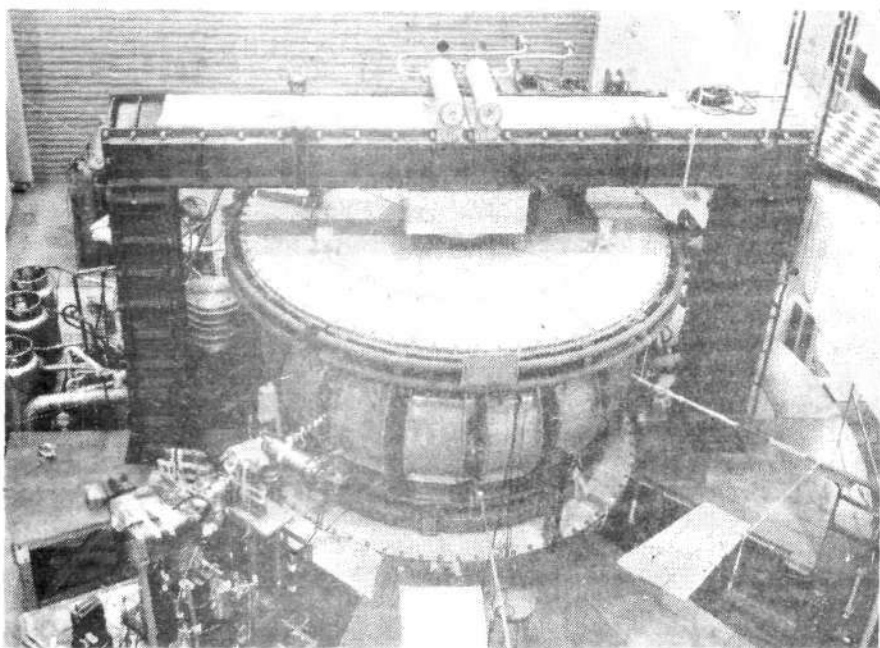

*The Japanese JFT-2 tokamak*

Hitachi, Toshiba, Mitsubishi and others are evidently responding to the governmental interest in fusion. I was told that Hitachi alone now has several hundred people working on fusion....This commitment seems to reflect not only the real need for new energy sources in Japan but also a conscious recognition of the role of advanced technology leadership in maintaining the economic health of the country."

The Japanese fusion effort is also surging ahead qualitatively, Fowler said. It is a broad-based program with a "variety of activities including research directions not actively pursued in the U.S."

### **Creative Leadership**

Dr. Fowler discussed several examples demonstrating the creative leadership the Japanese are already exerting in the world fusion effort.

First, Fowler reported, the Japanese have achieved successful microwave lower hybrid heating in the JFT-2 tokamak with up to a 50 percent increase in the plasma temperature. This approach is extremely important since it provides not only a means to reach fusion ignition temperatures but also a unique way to control fusion plasmas.

Second, Japan brought on line the world's first tandem mirror facility,

the Gamma 6, in March 1978. This promising new approach to fusion was theoretically developed at the U.S. Lawrence Livermore Laboratory and at Novosibirsk in the Soviet Union in 1975 about the same time that the Japanese developed it.

The U.S. inaugurated an unprecedented crash program based on the tandem mirror which is scheduled to come on line at Livermore next October. But Japanese fusion researchers at Tsukuba University moved much faster and their experiment is operating six months ahead of the U.S.

Third, Fowler reported that in the inertial fusion laboratory at Osaka, the 6 TW Gekko laser is almost ready for target experiments. In electron beam experiments, the Japanese observed that low atomic number metallic targets absorb more beam energy than high atomic number targets, perhaps due to the formation of a plasma corona, as apparently was the case in the successful fusion experiments of Soviet fusion researcher Dr. Rudakov.

"A formal collaboration between Japan and the U.S. in fusion research, as is now under discussion, is certain to be beneficial to the U.S. fusion effort," Dr. Fowler concluded.

—Charles B. Stevens

# The Council on Environmental Quality: Solar Energy at Any Cost

The Council on Environmental Quality, an advisory council to the White House, is widely circulating a report advocating a multibillion dollar program to transform the United States to a solar society by the year 2000. The report, "Solar Energy: Progress and Promise," lacks scientific credibility and in many cases is deliberately deceitful.

The CEQ's main argument is that solar technologies are not now competitive because fossil fuels and nuclear technologies are priced "artificially low." The CEQ solution? Price rises and a "20 to 40 percent" reduction in current U.S. energy consumption to make technologies "economically competitive."

"In the past, consumers of oil, coal, and gas have been subsidized through systems of price controls and through unpaid environmental and natural security costs," the report states. Similarly, it argues, nuclear power plants have been subsidized by tax credits and reduced-premium insurance.

Viewed without the CEQ's sun-screen, however, the fossil fuel and nuclear technology costs are artificially high. For example, the cost of producing oil is less than half of its current \$13 per barrel price. Similarly, if the nuclear industry were not hamstrung by environmental and non-proliferation regulations—regulations the CEQ has lobbied for—nuclear costs would be significantly lower.

## Solar Logic

Developing its negative growth argument, the CEQ continues: "Prices of oil and gas, artificially controlled at less than replacement values, have led to excessive overall energy consumption and waste." In other words, the prices of oil and gas are too low because they do not take into account revenue needed to develop new resources to replace depleted resources. This concept of "replacement value" is, of course, perfectly

correct when employed by a society dedicated to expanded economic and technological development. Such a society would see the development of fusion power as a necessary social cost now to ensure unlimited energy in the future. However, the CEQ uses this replacement value concept simply to justify making fossil fuel prices exorbitant so that solar technologies will be competitive.

Since solar technologies average out to be at least eight times more expensive than fossil fuels, the CEQ's "replacement value" concept would shoot oil and gas prices up correspondingly eightfold. By this logic, solar energy costs are competitive even though solar electric generation is by conventional scientific measures 20 times as expensive as fission and 80 or more times as expensive as future advanced fusion systems.

The CEQ's second line of argument

is that solar technologies would create jobs, and that because solar energy has a low labor productivity it would create *more* jobs than other energy sources. In other words, the more labor-intensive a technology is, the more jobs are needed for a given project. Using the same fallacious reasoning, the CEQ assumes, for example, that employing 400,000 persons on a solar home heating program is better than investing the same amount of money—in this case \$5 billion—to produce energy that would keep U.S. industry and its millions of skilled jobs growing.

The CEQ, established in 1969 under the National Environmental Policy Act, is the government's chief environmental thinktank and its staff members are leading zero-growth, antinuclear spokesmen.

—Carol M. Lerner

## Superconducting Tape Developed

The Electric Power Research Institute announced in mid-April that a new process for manufacturing continuous lengths of superconducting tapes for electrical transmission had been developed for the institute by Los Alamos Scientific Laboratory. This new superconductor could lead to the first economical U.S. superconducting transmission line, according to EPRI senior scientist Mario Rabinowitz.

The tape is coated with a niobium and germanium combination. Its unique feature is that it retains its superconducting qualities up to a high of 23 degrees K, while the currently used niobium-titanium alloys keep these qualities only to a temperature of 4.5 K. As a result, liquid hydrogen could be used as the coolant rather than the much more expensive liquid helium. Furthermore, the super-

conducting cable would require less refrigeration, allowing the development of simpler, more reliable, and less costly cryogenic systems. This is an important factor in reducing the cost, since refrigeration is the most expensive component of superconducting systems.

Commenting on the significance of the achievement, the EPRI report stated, "A major step has been taken—from small-scale laboratory-scale material (less than an inch) to production-line fabrication of conductors." The Los Alamos group demonstrated the continuous coating of the niobium-germanium onto moving tapes of 20-meter lengths, and scaling up to longer lengths suitable for commercial production should not present any major difficulties, Rabinowitz said.

—Marsha Freeman

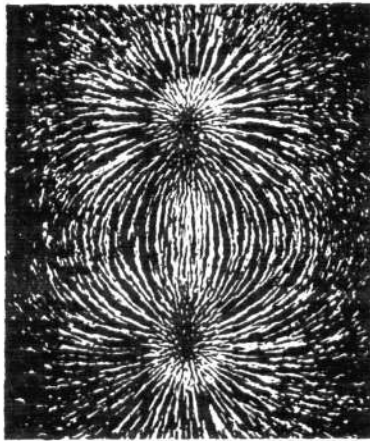

## Energy Potential

*Toward a New Electromagnetic Field Theory*

by Carol White

"...A penetrating historical analysis of the development of electromagnetic theory. It has pungent criticisms of the way in which standard textbooks have assigned credit for priorities and conceptual contributions."

—Dr. Winston Bostick

Professor of Physics  
Stevens Institute of Technology

"...An invaluable introduction to the physical theory of electricity and magnetism from the viewpoint of its historical development. It is a refreshing attempt to seek a novel interpretation of the concepts of energy and nonlinearity through the self-organizing tendency of electrodynamic systems. I strongly recommend this book to both laymen and students for its imaginative and provocative treatment."

—Dr. Fred Tappert

Senior Researcher  
Courant Institute  
of Mathematical Sciences  
New York University

**\$7.95** (add 10% for shipping and handling)

N. Y. residents add 8% Sales Tax.

To Order: Make check or money order payable to Campaigner Publications, University Editions, Box 1920, GPO, New York, New York 10001

Advertise in

# FUSION

Write or call for rate card:  
Fusion Energy Foundation  
Advertising Manager

Box 1943  
GPO New York, N. Y. 10001  
Tel. (212) 563-8618

## Mexican Scientist Discovers Asymmetry in Water Vortices

Since 1957 scientists have recognized symmetry of right-handed and left-handed phenomena is not preserved in certain processes on the microscopic level of the elementary particle (the nonconservation of parity). However, the creation of asymmetry from an initially symmetric situation has never been observed on a macroscopic level, involving the familiar forces of gravitation and electromagnetism.

Dr. E. Levi, a scientist at the University of Mexico, has recently demonstrated just such an inherently asymmetric macroscopic phenomenon. Levi's simple experiment involved directing a jet of water at the bottom of a tub of water. As the water jet spread out along the bottom, water was entrained from above, creating a water vortex at the surface, similar to an ordinary drain vortex.

Levi observed the direction of the resulting vortex and found that for shallow depths of water no preference was noticed. However, for depths between 25 and 35 centimeters, all

the vortices were counterclockwise in sense, while above that depth, all the vortices were clockwise in sense and much weaker.

To exclude the possibility that this asymmetry was introduced by the rotation of the earth, Levi had colleagues in Chile repeat the experiments. The Chilean researchers found identical results. Since Chile is in the southern hemisphere and Mexico is in the northern hemisphere, such results would not be expected if the Coriolis force (which determines the different direction of the swirl of water draining in a bathtub in each hemisphere) were the cause of the asymmetry. In any case, the force is extremely weak in small vortices.

Levi has proposed no explanation for the observed asymmetry of his results. However, if other researchers confirm these results, it would strongly suggest asymmetries in the gravitational field similar to those already observed in the microscopic field interactions.

—Eric Lerner

## Automated Tractor Possible

Fully automated farm machinery requiring no human operators would tremendously increase farm productivity both in the advanced and developing sectors, and free human labor for more skilled work. Although no such machinery now exists, agricultural engineers in Alabama took a step in this direction recently by working out the blueprints for a tractor with an automated traction system. Called autotraction, the tractor operates with a computer that is programmed to take soil conditions and other operational variables into account and quickly and accurately make such complicated decisions as when to change gears. With the addition of robots, a primitive automated tractor could be developed.

The autotraction system was designed by Robert E. Young, formerly of Auburn University in Alabama, and Robert L. Schafer, of the U.S. Agriculture Department's National Tillage Machinery Laboratory. It was reported in *Agricultural Engineering* magazine.

The autotraction system could revolutionize the agricultural economies of developing nations where there is a shortage of skilled workers because unskilled peasants could quickly learn to operate these simplified tractors.

# FEF News

## HARTFORD CONF. DRAWS HIGH-TECHNOLOGY INDUSTRIALISTS

More than 50 industrialists and engineers from New England's high-technology industry attended a FEF conference in Hartford, Conn. May 17 to discuss "U.S. Leadership in an Expanding World Economy." The group included representatives from five aerospace defense firms, a utility, a large engineering firm, an oil company, four colleges, a professional society, several Connecticut departments, three business associations, two labor unions, and the U.S. Labor Party.

The first panel—Hershel Klein of Combustion Engineering, Peter Stern Northeast Utilities, Claire Markham from the Connecticut Department of Planning and Energy Policy, and Dr. Morris Levitt for the FEF — debated the policies to finance nuclear development after Levitt called for a high-technology, export-oriented nuclear policy.

In the second panel Nancy Spannaus, U.S. Labor Party national executive committee member, discussed the "open door" to U.S. exports presented by the recent Brezhnev-Schmidt economic deal, while Kent Hansen, professor of nuclear research at the Massachusetts Institute of Technology, questioned the feasibility of a high energy growth rate, opening a lively discussion.

The final panel, "high technologies, education, and manpower," included Gaylord Northrup from the Center for the Study of Environment and Man, James Axon, chief of the apprenticeship program in the Connecticut Department of Labor, and Eric Lerner, director of physics for the FEF.

The conference received local television and radio coverage.



Lerner

## 'SOLAR POWER NOT ECONOMICAL,' ENVIRONMENTALIST CONCEDES

Dr. Kurt Hohenemser, top scientific advisor to environmentalist Barry Commoner, was forced to admit that he had not done his homework during a St. Louis debate April 15 with the FEF's Eric Lerner on fusion versus solar energy. "I agree solar power isn't economical, but you just can't have fusion," the ill-prepared Hohenemser said.

Lerner had showed how solar power was at least 10 times as expensive as nuclear energy. "The effects on industry of going solar would be disastrous, since solar power promotes primitive technologies," Lerner said.

The debate was sponsored by the Fusion Club of Washington University.

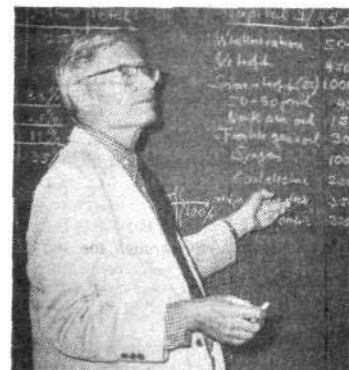

Hohenemser

## BARDWELL MAKES WHISTLE-STOP NORTHWEST TOUR

Dr. Steven Bardwell, director of plasma physics research for the FEF, made a whistle-stop tour of the Northwest the last week in April. At the University of Washington in Seattle, Bardwell debated Dave Ballon of the environmentalist Ecotopia Club before an audience of 250. "The debate is not over which technology will be used once you decide you want energy. Rather the debate is over whether the U.S. will continue to exist as a modern industrial power," Bardwell said.

To Ballon's incredible statement that man's role on earth is "to preserve the environment," Bardwell replied: "Nonsense. The human mind represents the pinnacle of the earth's development....Man's role is not as the protector but as the creator."

Bardwell was interviewed by a local Tacoma television station and also spoke before audiences at Pacific Lutheran University, an association of professional engineers, and a conservative political club.





Knoxville, Tenn.  
Austin, Tex.  
Albuquerque, N.M.  
Trenton, N.J.  
Cocoa, Fla.  
Bloomington, Ind.  
Boulder, Col.  
Bridgeport, Conn.  
New York City  
Madison, Wis.  
Cleveland, Ohio  
Cincinnati, Ohio  
Wichita, Kan.

Omaha, Neb.  
Kansas City, Kan.  
Anderson, S.C.  
Passaic, N.J.  
Jackson-Ann Arbor, Mich.  
Lansing, Mich.  
Fort Wayne, Ind.  
Pittsburgh, Penn.  
Joliet, Ill.  
Lafayette, Ind.  
Vancouver, B.C.  
Yakima, Wash.  
Waterbury, Conn.

### FUSION NEWSSTAND DISTRIBUTION UP 1,000 PERCENT

*Fusion* magazine is now available on newsstands across the country, in 27 cities and 20 states. The current issue has a minimum of 10,000 copies distributed, compared with the 650 copies of the January issue that were out on newsstands. Cities with newsstand distribution include Cleveland, Cincinnati, Pittsburgh, Austin, Kansas City, and the New York metropolitan area.

Sales returns from Knoxville, Tenn., one of the first distributors to take the issue, show a first time sales ratio of 62 percent. In addition to the increased readership of single issues, the distributor network has begun to bring in subscriptions and organization memberships from parts of the country where there are no FEF chapters.

### FEF HAS 40 CAMPUS CLUBS

FEF campus coordinator Dr. John Schoonover reports that "there are now 40 campus FEF clubs at colleges and universities around the country," most of them officially recognized campus organizations. The main impact of the clubs, he said, has been to establish a progrowth, pronuclear counterpole to the zero-growth ecology atmosphere imposed from the top down by well-funded groups such as Ralph Nader's PIRG (Public Interest Research Group).

### LEADING CARDIOLOGIST JOINS FEF BOARD

Dr. Demetrio Sodi Pallares of Mexico City has joined the FEF board of trustees. A leading international cardiologist, Dr. Sodi Pallares has pioneered in developing a polarizing solution treatment for heart disease. A forthcoming article by Sodi Pallares in *Fusion* will discuss his theory, which applies the concept of negentropy to the treatment of heart disease.

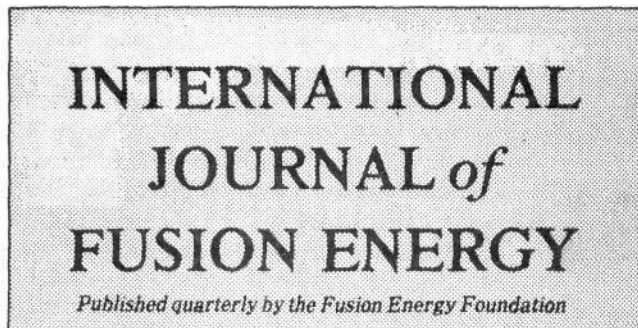
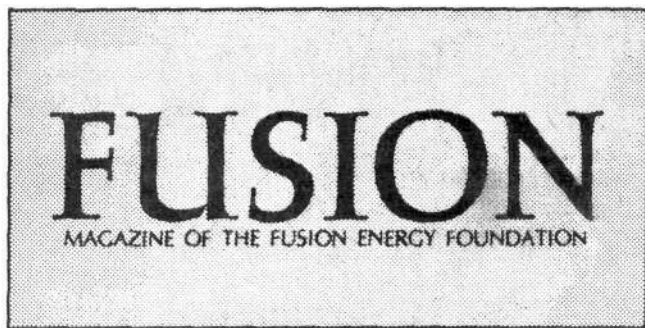

#### Coming in the July issue:

*"The Geometry of Visual Perception"*  
and  
*"The State of Thermonuclear Fusion Research"*

#### Coming in the spring issue:

*"Magnetic Confinement in Fusion Energy Research"*  
by Dr. Harold Grad

<input type="checkbox"/> FUSION magazine annual subscription (10 issues)—\$14	NAME _____
<input type="checkbox"/> FEF annual membership plus FUSION subscription—\$25	TITLE _____
<input type="checkbox"/> International Journal of Fusion Energy (4 issues)—\$35	ORGANIZATION _____
<input type="checkbox"/> FEF special membership (includes IJFE and FUSION)—\$50	ADDRESS _____
	CITY _____
	STATE _____ ZIP _____

Make check or money order payable to Fusion Energy Foundation and mail with order form to FEF, Box 1943, GPO, New York, N.Y. 10001. For subscriptions outside the U.S. and Canada, add \$5 each. All subscriptions must be prepaid in U.S. dollars drawn on a U.S. bank.

## Coherence, Not Chance, Is the Law of the Universe

Recent findings in physics and biology demonstrate that life on earth did not develop as a complicated mistake but that lawful processes govern the universe and its evolution.

"God doesn't play dice," as Einstein is famous for pointing out; he also doesn't shoot pool—the universe is governed neither by chance nor by the interaction of self-evident hard balls.

New insights to the most famous unsolved problem of classical mechanics—the three-body problem—show that the three-body puzzle remained unsolved for 300 years because its actual solution requires abandoning the Newtonian foundation of classical physics. As Dr. Steven Bardwell develops in his article, the real universe cannot be reduced to statistical arrays of tiny particles interacting at random like billiard balls.

And in biology, new evidence presented by Dr. Ned Rosinsky demonstrates that life started within a billion years after the formation of the earth and that it most probably began with primitive photosynthetic organisms. This fact demolishes the classical biology view of evolution as a product of billiardlike molecules that eventually result in the formation of scavenger-type organisms.

Coherence, increasing self-ordering, is the law of the universe.

Front cover: Photo by Philip Ulanowsky, courtesy of Stan Hirsut, McGirr's Billiard Academy, New York City.

Back cover: This photo of a DNA model typifies the result of the intersection of billiard ball physics with physiology. Only local-neighbor interactions are included in the model. Ignored is the evidence that DNA function depends on "field interactions" such as collective mode electrical activities, long-range forces, and interactions with the surrounding water and protein medium.

