

FUSION
ENERGY
FOUNDATION
Newsletter

**THE IMPLICATIONS
OF NONLINEARITY**

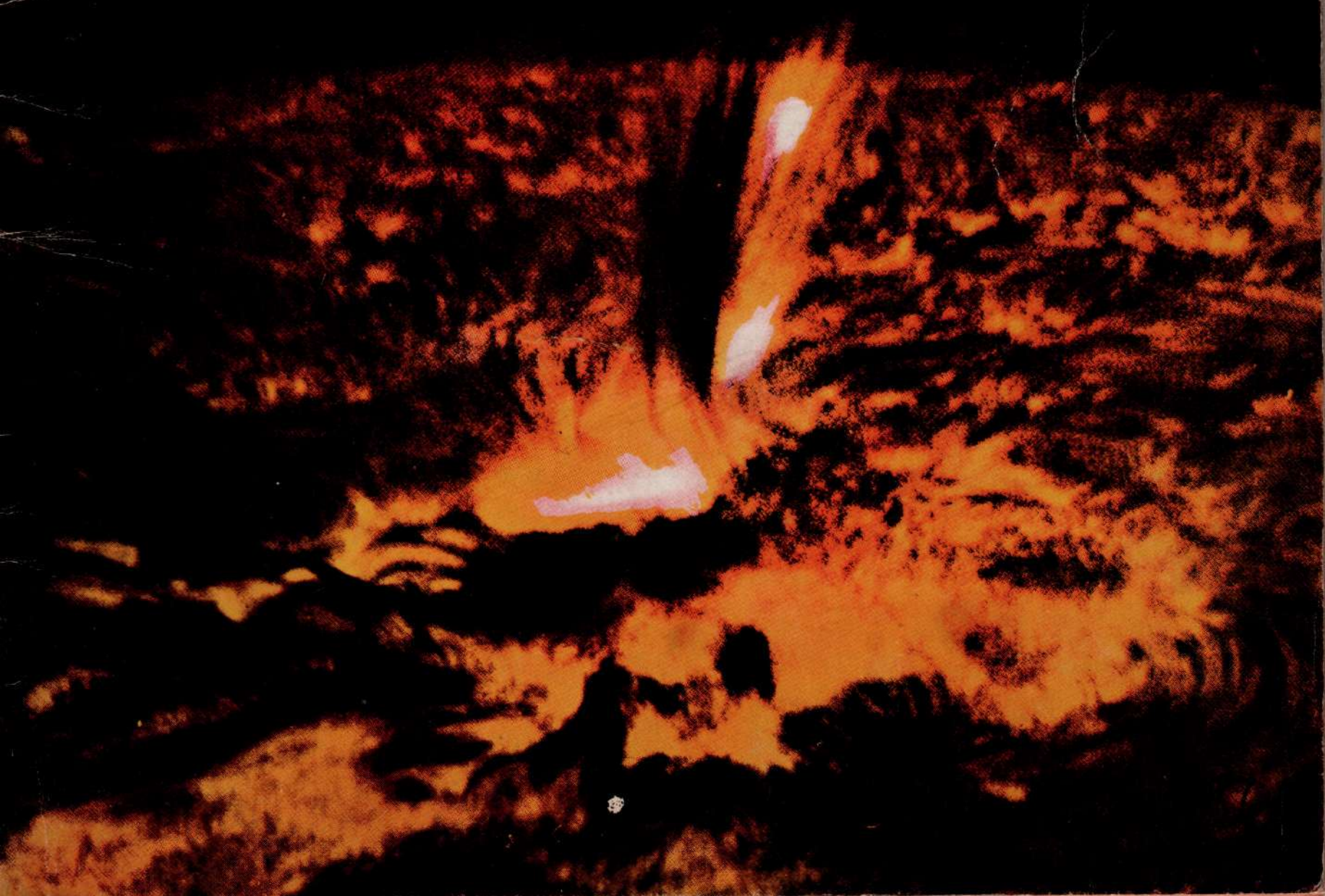

Fusion Energy Foundation Newsletter

Vol. II, No. 3
March 1977

EDITORIAL STAFF

EDITOR-IN-CHIEF
Dr. Morris Levitt

ASSOCIATE EDITOR
Dr. Steven Bardwell

MANAGING EDITOR
Marjorie Hecht

PRODUCTION EDITORS
Nancy Arnest
Christopher Sloan

The FEF Newsletter is published six times a year by the Fusion Energy Foundation. Editorial and subscription offices are at 231 West 29 Street, New York, N.Y. 10001. Subscriptions are \$10 per year or \$25 with annual membership in FEF.

Address inquiries to Editor-in-Chief, Box 1943, GPO, New York, N.Y. 10001.

The views of the FEF are stated in the editorial. Opinions expressed in signed articles are not necessarily those of the FEF directors or the scientific advisory board.

COVER:

Vortex filament-type structure in a solar flare. (See page 13)

CONTENTS

EDITORIAL

A Crash Program for Fusion Now 3

FEATURES

Frontiers of Plasma Physics III: The Implications of Nonlinearity
Dr. Steven Bardwell 4

Human Survival Depends on Nuclear Power
Jon Gilbertson 18

U.S. Aerospace — The Keystone to Fusion Development
Jon Gilbertson 24

FUSION RESEARCH NEWS

The Rudakov Affair

U.S. Fusion is in Second Place 30

Soviets on the Verge of a Strategic Weapons Breakthrough 31

Soviet Developments

Soviets Propose to Close Fusion Gap, Offer Cooperation to U.S. ... 34

Soviets Plan Fusion Reactor by 1980 34

Soviets Emphasize Broad-Based Approach to Fusion 35

Kosygin Urges International Cooperation on Fusion 35

Soviets Advance Fusion As Alternative to War 36

In the U.S.

Teller Endorses Soviet Drive for Fusion Power by 1980 36

New Fusion Breakthroughs at Lawrence Livermore 37

ERPI Report Confirms Sabotage of U.S. Laser Development 38

U. of Miami Reports Progress with Plasmoids 38

Fusion Torch Ready for Use in Industry by 1985 39

European Fusion News

Attempts to Stop European JET Program Backfire 40

Gas-Iodine Laser Advances 40

Swedish Plasma Physicist: "Don't Forget Fusion" 41

FEF NEWS HIGHLIGHTS

FEF National Campaign:
Repeal the National Environmental Policy Act of 1969! 42

Labor Party Circulating "Memorial on Energy Policy"
to State Legislators 42

Levitt Reviews Fusion Future for Washington Diplomats 43

Baltimore Conference Draws Industrialists, Scientists,
and Workers into Policy Discussion 44

FEF Testifies at ERDA Boston Hearings 44

European Labor Party Issues Program for Fusion Energy 45

A Crash Program for Fusion Now

The saga of the energy crisis during the 1976-77 winter makes it clear that a crash program for the development of fusion energy is not just a matter of opinion — it is an absolute necessity. The natural gas situation, now headline news across the country, is a case in point. Through sheer negligence, lack of capital investment, and political manipulation, we are faced with dwindling energy reserves — a man-made shortage, but one that is a reality nevertheless. A wishy-washy approach to fusion development, given these short-term shortages, won't work; we can't stretch out present resources and "wait" for future breakthroughs. The only sane solution to this dilemma is to immediately initiate a fusion research program on the scale of the Manhattan or Apollo Project. The alternative means destroying in the name of "conservation of energy" the capacity of our society to develop labor power and technology.

Despite the Ralph Nader movement's voluminous press coverage about the joys of conserving energy and returning to more "natural" anti-technological ways of life — wind-mills and fireplaces — most Americans worked hard to achieve their present standard of living and don't dream about a future in the Stone Age. They sweated to earn the money to get their children a better education, to get time-saving appliances in their homes. Their gut reaction to Nader's prescription for the future is *rage*: "If we could put people on the moon, dammit, we can find a way to keep industry going, to keep our homes heated, to keep our schools open!"

This revulsion at the antics of the Naderites (and the Carter energy policy) is absolutely correct scientifically. Fusion breakthroughs are within our scientific grasp. However, there is no way that we will be able to provide the qualitative standard of living and industrial development essential to be able to develop the scientific breakthroughs that will lead to fusion unless we rapidly *increase* our consumption of energy.

The idea of conserving energy in order to solve the energy crisis, in addition to being a profoundly anti-human idea, is pure hogwash. It's as if the Naders in our world would tell us that in order to conserve airplane fuel (so that our children can enjoy riding in airplanes) we must restrict the speed on the airport runways to 55 mph. Of course such prudent conservation means also that no airplane could ever take off: There is a law of gravity that prescribes a threshold of speed in the case of the airplane take-off. In the matter of energy and our society, there is also a threshold — conditions necessary for scientific development of "take-off."

Repeal NEPA

The Fusion Energy Foundation is tackling the energy question head on, attacking the major political and ideological roadblock to fusion power and scientific development in general — the National Environment Policy Act. Since it was voted into law in 1969, this anti-technological, zero-growth legislation has permitted the Naderites and assorted

environmentalists to stall, close down, and harass through court actions thousands of necessary industrial and development projects. Hundreds of thousands of Americans have lost jobs; worse, NEPA actions have prevented the growth of basic scientific research.

Let's look at one vivid example of NEPA's devastating influence — the steel industry. As this newsletter has publicized, about ten years ago a chemical engineer named Robert Jordan worked out a process for steel making that substituted oxygen for air in blast furnaces. Using existing equipment, the Jordan Process could immediately double steel production, producing valuable chemical by-products as well. The increased energy density which is the key to the Jordan process, offers as well a technology key to the transition to fusion.

Instead of investment in such advanced technologies, for the past seven years steel makers have sunk a total of \$7 billion into so-called pollution control — developing such gimmicks as smokestack "scrubbers" that have had a negligible impact on pollution.

If this \$7 billion had gone into converting just 35 per cent of the steel industry to the Jordan Process, pollution would have been drastically reduced and the world would have gained 40 million more tons of steel, 10 million more tons of ammonia (fertilizer) and 5 million more tons of methanol (a clean-burning fuel that could be adapted to automobile use). To use an even more striking measure of NEPA's incompetence, the 10 million tons of ammonia translates into 150 million tons of food — the difference of life or death by starvation in many parts of the world.

NEPA's record in other fields of science and industry is just as gruesome. Basic cancer research — on early diagnosis and cures — has been sacrificed for the search for carcinogens in the environment; innovations in automobile safety have not been developed because of airbags and the like. And, as this issue of the newsletter lays out in detail in two articles by FEF staff nuclear engineer Jon Gilbertson, the environmentalists have brought us the great plutonium hoax, preventing mankind from benefiting from nuclear energy. At the same time, this country's capacity for research and development — a capacity that traditionally has provided the basis for our society to grow — has been systematically gutted.

This issue of the newsletter should give readers a sense of where the FEF has come over the past year or so. The main feature by Steve Bardwell outlines the positive thrust for a research program in basic science — this has been, and remains, the most important area of FEF work.

That the FEF has achieved certain advances is clear; across the country there is now a coalition of legislators, industrialists, labor leaders, and scientists who are fighting for fusion development and who see the fusion battle as key in reindustrializing and advancing technology. But, the battle is far from won. In the political arena and in the laboratories the fight for progress remains central.

The Implications of Nonlinearity

Dr. Steven Bardwell

In the first two articles of this series, Bardwell reviewed the experimental evidence that points to an inherent nonlinear quality in plasmas. Evidence from strongly turbulent plasmas — where the energy in the plasma's collective motions is comparable to the energy in random motion — leads to the speculation that high energy-density plasmas can provide insight into previously inaccessible regimes of physical behavior.

Both laboratory and astrophysical plasmas show a marked tendency to generate self-ordered, large-scale structures: islands of self-generated magnetic field, circulation cells, vortices, and filaments are among the most remarkable of these. These self-ordered phenomena, Bardwell reports, challenge in a fundamental way the conceptual tools of physics as they are presently understood.

In part two of this series, Bardwell draws on the connection between linearity and entropy — a topic also examined in Levitt's companion piece in the September 1976 FEF Newsletter — to conclude that these difficulties in plasma physics stem from the invalid extension of contemporary physics, which is basically linear, to high-energy density regimes of a plasma: contemporary physics in these cases is inapplicable.

Readers without a background in mathematics should not be deterred by the mathematical formalism in the last section of the article; the text can be understood without a detailed mastery of the mathematical formulae.

The central concept of this series of three articles is nonlinearity — nonlinearity in a sense that extends the usual meaning of the term in mathematical physics. At this point in the development of physics, especially of plasma physics, it is necessary to specify the idea of a nonlinear system and to denote a series of qualities that, although included in the usual meaning of nonlinearity, elucidate the more fundamental basis for the concept. This is not a matter of redefinition, but an empirical question: Can we adequately deal with the phenomena of present-day plasma physics, both theoretical and experimental, using the conventional conceptual framework?

Such an elaboration of plasma physics is essential (See Tsytovich 1976). Experimental evidence in the last year, in particular, has shown with astounding regularity the occurrence of spontaneously ordered structures in plasmas. This tendency to form solitons, self-accelerating groups of particles, self-generated magnetic fields, and the like is especially characteristic of plasmas in the strongly turbulent regime.

Based on experimental and theoretical study of these "self-ordered" phenomena, it is now possible in fact to provide two steps in the development of the required concept of nonlinearity. First, we are able to delineate with at least qualitative rigor what a nonlinear concept of physics would entail and contrast it with present linear conceptions. Second, we can describe the initial directions that a research program on nonlinearity should take.

This second item is especially important and realizable in the context of a serious crash program for fusion development of the sort that the Fusion Energy Foundation has proposed in the Fusion Energy Research and Development Act of 1977, which calls for the establishment of ten National Basic Research Centers, each funded by an annual budget of \$300 million and equipped with large computer, laboratory, and educational facilities.

Nonlinearity Versus Linearity

The following section briefly lays out the central features of the fundamental basis of nonlinearity in contrast to those of linearity. (This material is also summarized in outline form in Table 1.)

Dynamics On an historical basis it is abundantly clear that the central specification of a physical system is that it have only one mode of operation or quality of interaction. A steam engine, an electric motor, and so forth, are characterized by their restriction to a single and fixed kind of possible behavior. The same quality is ascribed to the solar system, once it has come into being, and to a "perfect" gas, as long as it undergoes no phase changes, to give two other examples.

In contrast, a nonlinear system has the immediately obvious feature of self-developing modes of interaction. The work done by the group under David Montgomery at the University of Iowa on two-dimensional fluids and plasmas is an excellent case study in the characteristics of this new con-

Table 1

THE CONCEPT OF NONLINEARITY

Characteristic	Linear System	Nonlinear System
Dynamics	Unimodal, given by fixed laws	Self-developing (Cantorian)
Energy	Energy a property of each particle individually, $E_k \gg E_i$	$E_k \approx E_i$; concept dependent on direction of evolution
Accessible states	All states can be listed; causal and deterministic; statistics applicable	Infinite dimensional phase space; inherently dynamic; critical role of marginal effects; causal but not deterministic
Quality of evolution	Second Law of Thermodynamics holds; H-Theorem can be proven	Nested sets of incommensurable geometries, each of which is Riemannian

cept of nonlinearity. A remarkable feature of the time evolutions of the fields and flows in Montgomery's two-dimensional plasmas is the changes in interaction that occur as the plasma evolves. In these experiments, there is a sharp threshold in the behavior of the plasma (when the energy changes from negative to positive) as its evolution becomes nonthermodynamic, and large-scale ordered structures (vortices and closed magnetic fields) appear.

The most appropriate mathematical model for this feature is Georg Cantor's work on the structure of the number system. Both the number system and a nonlinear system have no fixed law that determines the kind of relations possible between the elements of the system; rather, their laws are hierarchical in nature and can change as the system develops. As Cantor pointed out in 1883, the only unchangeable laws are those that prescribe the possible forms of this evolution (Parpart 1976; Cantor 1883). The laws that describe any one stage in this process are then derived from the evolution leading up to that stage and from the "jump" or phase change that created the stage. The relationship in question here is the same that Cantor develops between his "two principles of generation of numbers," (corresponding to general law) and the rules that determine the algebra of

denumerable sets (Peano's axioms, for example), corresponding to the laws describing one stage.

It is at this point that V.N. Tsytovich's review paper on the interaction of relativistic electron beams and plasmas (1976) is valuable. Tsytovich points out clearly the evidence for a phase change occurring in the transition from weak to strong turbulence in a plasma, characterized by the onset of self-ordered phenomena. He also notes the resulting necessity for a new conceptual basis for the study of the strongly turbulent plasma.

Energy The dynamics of a system imply the acceptable concept of energy for that system. In a linear system, the energy is defined on the basis of kinetic energy, and the energy of the interaction of the particles in the system is defined deductively based on the conservation of energy. The qualitative idea of energy that results is primarily definable in terms of each particle in itself and, only secondarily, in the fields and coherent motions — and this only as a result of the motions of the particles.*

For a nonlinear system, the inequality $E_k \gg E_i$ where E_k is the random kinetic energy density of the plasma, and E_i is the collective mode energy, is no longer satisfied. In itself, this means that the linear conception of energy is not

* Prigogine (1968) neatly outlines the connection between energy and particles:

What is the relation between particles and fields? For free fields, this is trivial, but it is no longer so for interacting fields. If some canonical transformation could reduce the Hamiltonian to a sum of independent terms, there would be no problem, but that seems out of the question. Therefore, we have to involve other considerations to introduce the particles associated with the interacting fields. If we may realize a representation in which the entropy at equilibrium and out of equilibrium has a purely combinatorial meaning in terms of particles, we may consider

these particles as the "physical" particles associated with the initial Hamiltonian.

One could say that we use the classical argument about entropy in a reverse form: one proves usually that particles, when weakly (that is, in a linear system — ed.) coupled, have a combinatorial entropy. We put entropy in the combinatorial form and conclude that the particles are then well-defined, physical entities.

With nonlinear systems, even this expedient is unsatisfactory, because the representation of the energy function (Hamiltonian) required turns out in some cases, to change with time, in others to be multiple valued, and in still others to be nonexistent.

adequate. (Levitt 1976 shows this in detail.) In its place, we must supply an energy derived from the direction and quality of the evolution that the system is undergoing. One of the most striking phenomena in a nonlinear evolution of a plasma is the tendency for the energy to concentrate itself and to increase its density in such a way that further energy concentration becomes possible.

In the case of the plasma focus, for example, an initially diffuse, disordered energetic plasma is accelerated across a magnetic field and quickly develops a complex structure of filaments. By the time these filaments reach the end of the focus, the energy density of the filaments is approximately 100,000 times greater than that of the initial plasma. The concentration of energy, in turn, generates fields that accelerate deuterium ions to sufficient energies to initiate fusion reactions.

This kind of behavior is different from the usual statement about strong turbulence, for example, that E_k is comparable to E_t , in contrast to weak turbulence, where the linear approximation of $E_k \gg E_t$ is valid.

While this statement is formally correct, the energy in the strongly turbulent plasma is no longer close enough to the Maxwellian equilibrium to actually define a temperature. The empirical fact is that strong turbulence is usually less random than weak turbulence, that the instabilities characteristic of the onset of strong turbulence produce states of macroscopic order (like circulation cells, solitons, and so forth). Thus, a statement of the energy relations in a strongly turbulent plasma based on an analogy with thermal energy in a weakly turbulent plasma fails; the energy of a strongly turbulent plasma is in a qualitatively different form — large-scale coherent motion that is self-concentrating.

Accessible states The foundation of statistical mechanics is the calculus of phase space. This is a powerful technique for studying a linear system, but only because all the possible states of the system can be specified in advance. In a more rigorous sense, the phase space for a linear system is measurable, even though it may be infinite in extent. The ability to enumerate all the possible states of a system is a prerequisite for application of statistics to any situation.

In a nonlinear system, however, it is impossible to apply statistical mechanics with the same rigor. As Prigogine notes, systems governed by a nonlinear partial differential equation are characterized by an *infinite dimensional* phase space (1974). While this obviously does not exclude the application of statistical arguments to suitably restricted situations (to the mean values of the temperature, entropy, and so forth in the study of two-dimensional fluids, for example — although even here, the fluctuations about these mean values are arbitrarily large when the system is self-ordering), the system's dynamic and coherent features escape this treatment.

This difficulty reflects a fundamental feature of nonlinear systems: they are causal but not deterministic. There is little question that a linear system evolves according to cause and effect relations, and that these relations are deterministic. A nonlinear system, however, seems to separate the properties of causality and determinism. The initial conditions in a linear system specify not only the evolution of that set of conditions, but also a neighborhood of similar initial states that have neighboring final states.

In contrast, the evolution in a nonlinear system is governed by nucleation, phase change, and similar singular processes. Again we look at a two-dimensional plasma whose behavior raises very disturbing questions. How, for example, when the initial state is one of maximal disorder (that is, the initial distribution of turbulence is distributed with a Gaussian noise spectrum) does the plasma contrive to order all the collisions of fluid such that the final state is one in which the

motion of the plasma is in two large, counterrotating vortices and generates force-free fields?

These processes are causal, but they result in dynamics that allow grossly different final states to come out of very similar initial states (Prigogine 1974). For this and associated reasons, marginal effects play a critical role in nonlinear systems; the intuitive feeling that "big effects are due to big causes and little effects are due to little causes" is no longer true.

It should be stressed that the statistical approximation to this problem — based on the perception that since noise supplies the singularities, causality is somehow superseded — is fundamentally wrong (Prigogine 1974). Several examples discussed below present alternative approaches to this problem.

In this context the role of small, or marginal effects on nonlinear evolution makes the coexistence of discrete, particulate sources and continuous field quantities most problematic. This philosophic-mathematical question is one to which both Cantor and Bernhard Riemann devoted considerable attention, and it is at the core of the difficulties of any attempt at a unified field theory. The inadequacies of the statistical approach to this situation — the type that characterizes nucleation theories of phase change, for example — is well illustrated by the antinomies of quantum mechanics, where the relation between the discrete properties that a source introduces into an otherwise continuous field quantity can only be postulated.

At this point, quantum mechanics has left this essential nonlinearity as an a priori construct. The failure to deal with this built-in discreteness is the source of the manifold contradictions in quantum field theory. It is useful to contrast to this *indifferentism* (as Immanuel Kant called a similar avoidance of this same difficulty on the part of 18th century English philosophers) the alternative approach of Riemann in his construction of the geometries of functions of a complex variable, where the singularities *determine* the global characteristics of the function.

In a similar way, recent theories of phase changes and similar singular behavior have involved considerations of the symmetry properties of a system induced by a singularity in some state function of a system. The singularity and its global effects (symmetry breaking, and so forth) have given some initial guides to the study of the usually coherent state that the phase change introduces. (See Ruelle 1971, for example.) However, plasma physics has not followed even these initial directions.

Quality of evolution Ludwig Boltzmann's most profound contribution to physics was to demonstrate that a linear system, as defined above, is subject to the Second Law of Thermodynamics; he proved his H-Theorem only for linear systems as Levitt has shown (1976).

To define the central quality of evolution for a nonlinear system is considerably more problematic. At this point, the most advanced conception of that evolution is based on the analogy with the work of Cantor mentioned above. To begin with, Riemann's injunction about the inseparable connection between geometry and physics forms the basis for considering any given phase of nonlinear evolution; the geometry itself must be a dynamic quantity. In addition, we must be able to describe the almost discontinuous transitions in the evolution of nonlinear systems, and Cantor's work provides an analogy for this process. A mathematical description of nonlinear evolution is a nested set of incommensurable (Cantorian) manifolds (Riemannian) — manifolds whose internal dynamics are self-generated.

Again, this kind of process is well illustrated by Montgomery's two-dimensional plasma simulations. In these plasmas the initial state is isotropic, but the final state is

highly anisotropic, even though all the equations of evolution are themselves invariant under rotations. Furthermore, the physical interactions of the plasma, especially the long-range electromagnetic interactions, are responsible for the evolution from disorder to long-range order. It is remarkable that a two-dimensional fluid possesses this property of an inverse cascade of energy, but that a three-dimensional fluid does not. However, both a two-dimensional and three-dimensional plasma possess this property of supporting inverse cascades. According to recent work by Uwe Frisch, this property is due to the conservation of magnetic helicity, a specifically long-range, nonlinear interaction that is present in the plasma but not in the fluid. This is a clear-cut case where the nonlinear interaction results in a qualitative change in the geometry of the evolution, essentially forcing the three-dimensional plasma to behave like a two-dimensional fluid.

The Riemannian part of this conception has led to some new developments in the understanding of self-ordered phenomena in plasmas, reviewed below, but the Cantorian idea of the phase change representing a change in this Riemannian geometry of the system is as yet unelaborated.

An adequately developed concept of a nonlinear system along these lines should serve several purposes. Most important, it must provide a guide to a program for experimental research that can begin to probe the complexities of the high energy-density regime in a plasma. As part of this research program, moreover, the problem of assessing the state of contemporary physics can become experimental; a concentrated program of research into collective phenomena at high energies will quickly push present physics to the limits of its applicability, showing quantitatively where present conceptions are inadequate. Such a program oriented toward the frontiers of science will also raise, in a very pointed way, the pedagogical problems of physics, forcing a coming-to-terms with a truly transfinite physics.

A Successful Plasma Research Program

Cantor describes the context in which a successful research program can take place:

We can speak of the reality or the existence of the whole numbers, both the finite and the infinite ones, in two senses; however, these are the same two ways, to be sure, in which any concepts or ideas can be considered. On the one hand, we may regard the whole numbers as real insofar as they take up a very definite place in our mind on the basis of definitions, become clearly differentiated from all the other components of our thinking, stand in definite relations to them and modify the substance of our mind in a definite way. Let me call this type of reality of our numbers their intrasubjective or immanent reality. Then again we can ascribe reality to numbers insofar as they must be regarded as an expression or image of occurrences and relationships in the external world confronting the intellect, further, insofar as the different number classes, (I), (II), (III), and so on represent different powers, which in fact occur in corporeal and mental nature. This second type of reality I call the transsubjective or transient reality.

Given the thoroughly realist — simultaneously, however, no less idealist — foundation of my investigations, there is no doubt in my mind that these two types of reality will always be found together, in the sense that a concept to be regarded as existent in the first respect will always in certain, even in indefinitely many ways, possess a transient reality as well. Admittedly, the determination of this reality is generally among the most troublesome and difficult tasks of metaphysics and frequently it must be left to a time when the natural development of another science reveals the transient significance of the concept in question.

Plasma physics, I contend, is at the stage where its “natural development” uniquely suits it to provide the experimental elaboration of the concepts of self-development and self-organization — which are certainly “immanent” in plasmas and which characterize living systems and human thought — and demonstrate their application to a “transient” reality.

The essential task of a research program in basic science must be to develop specific attacks on the problem of nonlinearity that will illuminate the underlying transfinite nature of the problem. At this point, the clearest lead on the problem is the large and remarkable class of self-ordered structures that a plasma supports. In almost every high energy-density plasma the nonlinearity of the plasma exhibits itself in the formation of singular, coherent objects: solitons in electron-beam produced plasmas, self-generated magnetic fields in laser produced plasmas, circulation cells in multi-pole machines, filaments of various sorts in the plasma focus, force-free vortex structures from plasma guns, magnetic islands in Tokamak machines, and self-generated particle beams in astrophysical plasmas, to name some of the most spectacular instances.

These large scale, coherent phenomena constitute the most accessible (theoretically and experimentally) approach to studying nonlinearity. The structures not only provide the most outstanding consequences of the inherent nonlinearity of a plasma (in the sense that the nonlinearity is not derivable from any linear regime); more basically, they

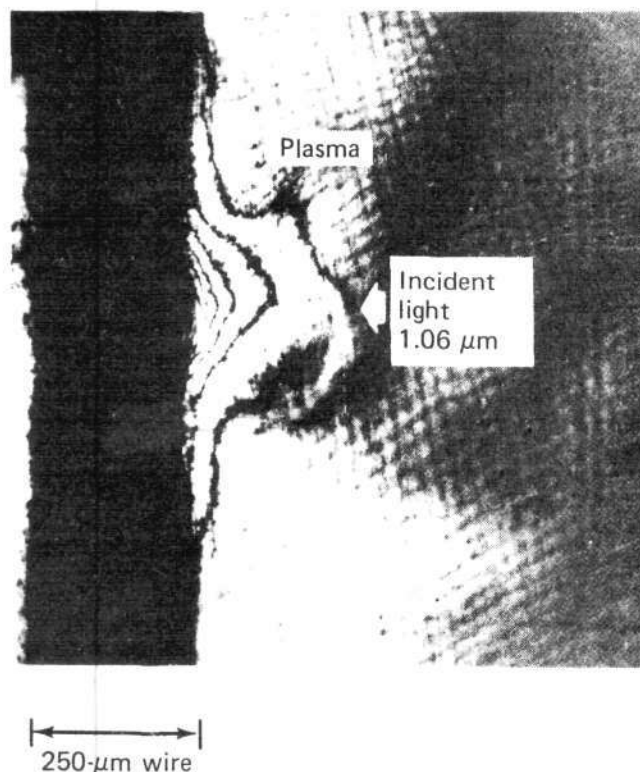

Figure 1

A plasma interferogram of a laser incident on a wire. This photograph was taken using a second laser with a wave length of 3547 Angstroms. The contours show increasing plasma density at one instant of the expansion of the exploding surface of the wire.

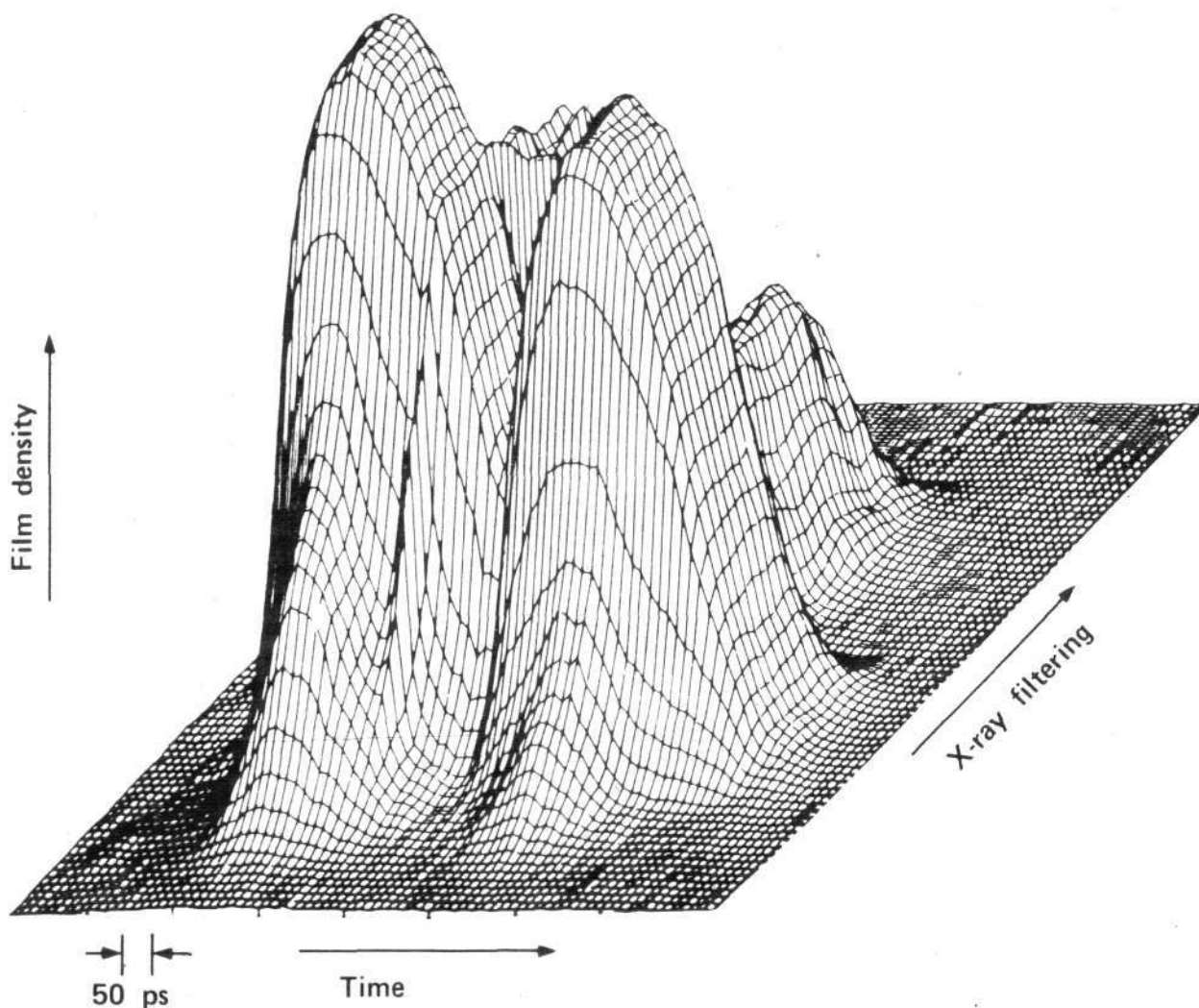

Figure 2

A three-dimensional representation of the information derived from an x-ray photograph of a laser-implosion of a pellet. The time axis shows a resolution of about 13 picoseconds. The axis labeled x-ray filtering is a measure of energy, and the axis labeled film density is a measure of intensity of x-radiation.

provide immediate implications concerning the microscopic basis of the phenomena.

It is remarkable that the gross, macroscopic behavior of a system should be looked to for insight into the microscopic, particle-based processes. This is the case for two reasons. First, as Prigogine points out in the paragraph above, what we mean by particles is actually a function of the macroscopic resultant motion that particles can support. The form of the Hamiltonian of a system, while made up of terms that reflect the particles, defines what are in actuality particle-like "degrees of freedom." Second, a nonlinear system is not really composed of either discrete particles or the continuous interactions between these particles. Rather, as Cantor points out, the mutual determination of these continuous and discrete aspects of the system is the key to understanding its

behavior. This implies that the usual division between micro and macroscopic regimes is untenable in any useful sense.

A Zoology of Plasma Phenomena

The central task of a research program on nonlinear behavior is to develop a zoology of these global, structured phenomena. The aspects of the phenomena that provide a basis for the zoology follow from Table 1. Especially important are the two following general categories of results:

Geometrical behavior The topology of the magnetic field lines provides a sensitive tool for studying the internal structure and dynamics of these self-ordered phenomena. This is especially clear in the almost universal appearance of closed field structures — magnetic islands, reversed fields,

magnetic braiding, formation of neutral layers, and self-generated magnetic fields. In every instance where these phenomena have been investigated with care, significant particle fluxes have been observed in association with the self-generation of new topologies of the magnetic field.

In addition, these closed field structures and particle fluxes frequently appear in a force-free configuration where the magnetic field and plasma velocity are everywhere parallel. Currently, these phenomena are poorly understood both theoretically and experimentally. I will outline more detailed results in this area below, but in general the topological behavior of the magnetic field and the associated particle motions are essential features of nonlinear processes in astrophysical and laboratory plasmas.

Dynamic behavior The dynamics of nonlinear, structured behavior are obviously complicated, but one feature is especially noteworthy and revealing of the underlying features of such behavior: specifically, the tendency for self-generated increases in the energy density of the plasma. This seems to be a very pervasive feature of nonlinear behavior. In the formation of solitons and filamentation in magnetized plasmas (in the plasma focus, for example), plasma processes take the initially disordered energy imposed on the plasma (or Langmuir turbulence in the case of an electron beam-created soliton) and create inhomogeneities in energy density on the order of 10^5 .

The spontaneous generation of such a remarkable difference in the spatial distribution of energy is a regular feature of nonlinear evolution, and its appearance in astrophysical, geophysical, and laboratory plasmas indicates a systematic connection between this and the underlying transfinite nature. It is worth noting that this tendency has an immediate practical consequence: The laser group at Los Alamos has just reported their latest reevaluation of experimental and theoretical work on laser interaction with a plasma. In contrast to previous estimations, they conclude that the wavelength of the laser radiation is not important in determining the efficiency of the coupling of the radiation with the plasma. Specifically, this is true once the laser intensity is sufficient to generate a radiation pressure comparable to the plasma pressure. If we recast this threshold into energy density terms, it is the same as the threshold for the transition from weak to strong turbulence (which occurs at the point that the energy density in coherent motion is comparable to the thermal energy density). *In effect, the plasma reshapes its density profile to maximize the absorption of energy.*

These guidelines indicate the following three experimental and theoretical lines of research, which are of approximately equal importance.

Development of Microdiagnostics

One of the most consistent barriers to developing the data necessary for the study of magnetic field topology, filaments, and so forth, is the fact that most present experiments have insufficient spatial and temporal resolution in their diagnostics to distinguish phenomena of this type.

The problem is most obviously acute in the case of laser-pellet interactions. To study the details of the exchange of energy in this interaction, a time and space history of the plasma and radiation are necessary, requiring particle (especially neutron) and radiation spectroscopy that has a time resolution measured in picoseconds and a spatial resolution in tenths of microns. In both time and space resolution, this is several orders of magnitude smaller than present techniques have achieved.

The problem, however, is by no means restricted to such spectacularly dynamic situations. As a number of researchers have pointed out (for example, C. Massonier and

William Bostick), the understanding of the plasma focus depends on the microprocesses of filament formation, self-generated magnetic fields, and rapid changes in the topology of the plasma. These require measurements of plasma densities, temperatures, currents, and magnetic fields with time resolution of one tenth of a nanosecond and spatial resolution on the order of a tenth of a millimeter. A list (not exhaustive) of specific diagnostic devices follow.

Visible light photography The perfection of subnanosecond exposures, of moving picture cameras, of holographic techniques, and image enhancement are the most obvious areas where work is needed.

Electromagnetic spectroscopy X-ray camera techniques are well established but have not achieved the spatial resolution of which they are capable. In addition, the soft, very soft (into ultra-violet) x-rays are an ignored part of the spectrum, primarily because of the difficulty of detection; yet they are known to play a key role in a number of plasma processes, especially with electron beam-plasma interaction. In astrophysical contexts, the same considerations of time and space resolution apply, but the EM radiation involved tends to be in the radio to low frequency range. Again, time-resolved spectroscopy, in particular, is essential in understanding the dynamics of striation formation in the ionosphere, resonant amplification of EM radiation, magnetic line topology, and particle acceleration. As discussed below, there is convincing evidence that these nonlinear processes involve the same kind of self-organized behavior that is clear in the higher-temperature laboratory plasmas. Especially crucial is the development of directional and highly space-resolved radiation measurements for use in satellite experiments.

Secondary EM diagnostics Perhaps even more important for understanding plasma dynamics is the use of secondary EM radiation to probe the density and velocity structure of the plasma. The classic methods of microwave and laser diagnostics both need to be enhanced with the development of very short pulse, repeated probes. The use of various first-order nonlinear (in the usual sense) interactions, like harmonic generation and Raman scattering, are important and have tended to receive considerable attention.

Emitted particle spectroscopy There are many techniques now used but, as in the techniques discussed above, the time, space, and energy resolution tends to be many orders of magnitude greater than required for a dissection of the phenomena that occur even on relatively gross spatial scales. To cite one example: in almost all experiments that generate a large number of fusion neutrons, there are non-simultaneous bursts of x-rays and neutrons. Both tend to be very sharp and localized, at least in the sense that they are smaller than the resolution of the instrument. The structure and mechanism involved in this interplay of the magnetic fields, particle acceleration, and radiation are largely unknown. But the same conjunction of high-energy effects occurs in the magnetosphere, the plasma focus, laser-irradiated pellets, and Tokamaks whenever magnetic field lines change topology.

We need highly resolved experimental data to understand these phenomena.

Field structure The problem again is of measuring short-lived and small structures, especially in the magnetic fields. The current interest in the so-called disruptive instability — which in a Tokamak accompanies a change in the small-scale structure of the magnetic field, with the onset of braiding, formation of circulation cells, and the like — is a clear instance where the lack of a microscopic Rogowski coil or a Faraday rotation diagnostic with greater spatial resolution that is able to withstand very hot plasmas makes it almost impossible to do more than hypothesize about these phenomena. This is a serious impediment to the development

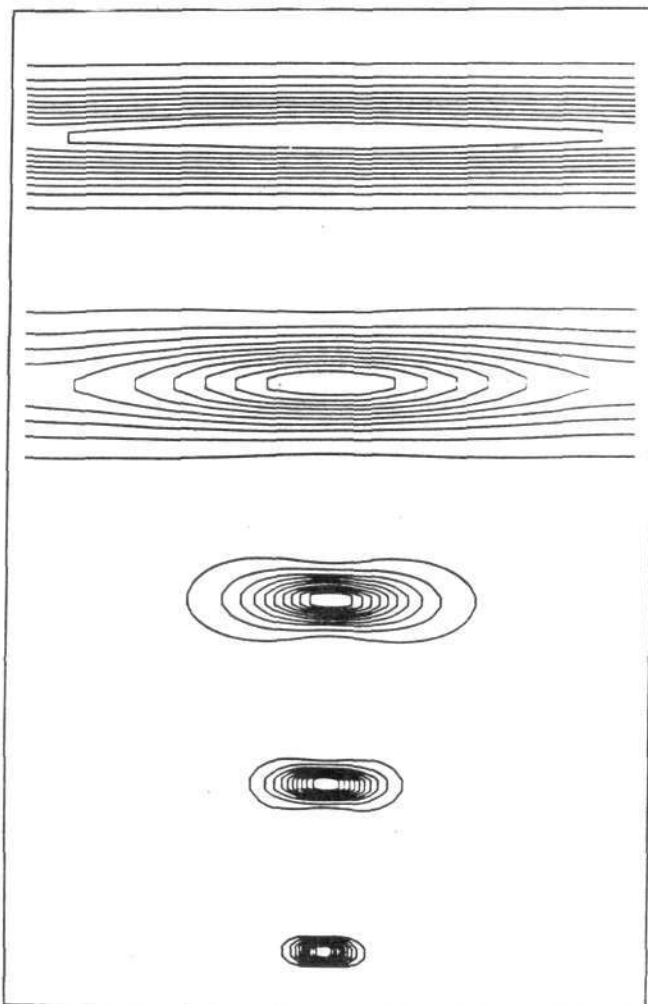

Figure 3

This example of a computer solution to plasma equations shows the collapse of an electric field (measured in terms of E^2 — the electric field energy density) into a soliton. Time increases as the pictures go down. In this solution, an electric field, initially almost uniform, collapses into a small ball.

of field-reversed configurations and their relatives (screw pinches, and so forth). Perhaps more than any other diagnostic, the field configuration conveys information about the nonlinear structure of the plasma, and the information that it contains concerning broken symmetries, onset of instabilities, and other phase change-like qualities is, for that reason, essential. A substantial effort to develop techniques for measuring these field topologies is of the utmost importance.

Theoretical Studies of Ordered Phenomena

In the past 25 years there has been a significant body of theoretical work in quantum mechanics and statistical mechanics that bears directly on plasma physics. If this is coupled with classical work on hydrodynamics, where ordered, intrinsically nonlinear behavior is the rule, some potentially fruitful lines of theoretical research emerge. One such research line, epitomizing a union of quantum field theoretic techniques applied to hydrodynamic conceptions, is

outlined below. In addition, the large body of work on cooperative phenomena in quantum fluids, solid state theory, and chemistry has an immediate relevance to the similarly cooperative behavior that occurs in plasmas. I have grouped this theoretical work into four, somewhat arbitrary categories.

Hydrodynamics The most important theoretical work in nonlinear, self-ordered behavior in plasmas has come out of the use of hydrodynamic conceptions of structure (vortices, most clearly; see Bardwell 1976 for a review of work by Wells and others). In the second section of this article, I discuss some very recent work by Lamb and Wells that has taken these ideas even further.

Statistical mechanics Since the development of a theory of nonlinear and nonequilibrium thermodynamics, a number of important concepts that have a statistical mechanics background have been used with considerable power in many-body theory: symmetry breaking, phase changes as singularities in state variables, renormalization theory, and stability theory.

Cooperative Phenomena As the review by J. Haken (1975) describes in considerable detail, the study of qualitative reorderings of macroscopic geometry is a feature of many systems, like lasers and superfluids, that have been amenable to a treatment involving the explicit use of these self-ordered structures. Plasma physics may be susceptible to similar treatment.

Numerical studies In the past, numerical studies have provided consistent inspiration into new effects (like solitons). This tool should be available on a broader scale. This means, generally, more money for large, fast computers.

In the concluding section, several areas of theoretical research are examined in detail providing a preview of the sort of theoretical research that must be undertaken. However, by its very nature, theoretical research cannot be prescribed in the sense that one can prescribe an experimental program. Thus, I have indicated some lines of possibly valuable attack; the actual theoretical work that underlies these areas of plasma physics must come out of the organic growth of the subject itself.

Experimental Investigations

In the context of the theoretical and diagnostic work considered above, a number of very important experiments become possible. Among the most important are the following five major experimental projects.

A large plasma focus The design and initial construction of a large (16 megaAmp, 4 megajoule) plasma focus equipped with the most sophisticated diagnostics must be a priority project. The nonlinear effects described in this article occur in abundance in such a machine but have been studied only in small machines.

Experiments on plasmoids The experiments on rings of plasma at Cornell University and the Naval Research Laboratory in Bethesda, Maryland and on similar plasmoids at the University of Miami are striking examples of the self-generated structures observed in plasmas in the laboratory. These experiments need to be adequately funded and combined with facilities that are capable of applying the higher energies necessary to understand the properties and stability of the structures. Especially important in this respect is the development of technologies for the compression of such structures. Magnetic fields and liquid liners have been considered, but these are marginal and as yet unfunded possibilities and must be pursued.

Diagnosis of the Tokamak Since the Tokamak is central at this point to the program for fusion development and already includes a tremendous amount of study, the dismal state of

understanding of even the experimental aspect of plasmas in this regime cannot continue. Although there is a relatively long time-scale of the phenomena involved, the diagnostic problems are large. As described above, the application of microdiagnostics to the particle and field configurations inside the Tokamak must get high priority.

Astrophysics Perhaps the most neglected laboratory for nonlinear phenomena in plasmas is the ionosphere, magnetosphere, and solar wind. In two areas specifically, recent results indicate tremendously important evidence for the primacy of self-structured nonlinear phenomena in these astrophysical contexts as well as for their relevance to the higher-density situations that occur in terrestrial laboratories. First, satellite data show a close connection between changes in the magnetic topology of the bow shock (the configuration of plasma and fields generated by the solar wind impinging on the earth's magnetic field) and acceleration of particle fluxes. However, as noted above, there are insufficient data to do more than speculate on the relationships that underlie this astronomic disruptive instability. More satellites are necessary, equipped with more sophisticated diagnostics for angular, temporal, and velocity resolution of these particle measurements and for the details

into hydrodynamics offers problems in nonlinear structure parallel to plasma phenomena in many respects. In addition, hydrodynamics research is amenable to experimental work in regimes where a plasma does not exist. Theoretically, for example, the role of vorticity is undeniable in classical and quantum fluids, but its importance in plasma physics is still misunderstood.

The impetus for conceptual cross-fertilization from a renewed research program in fluids must come from plasma physics. Perhaps most immediately relevant in achieving this interaction is the computer work going on in meteorology at the National Center for Atmospheric Research in Boulder, Colorado. Here, plasma physicists and fluid dynamicists have used models of two-dimensional fluids and large-scale numerical studies of actual atmospheric dynamics in weather prediction. Under the purview of a research program in nonlinearity this work must be expanded.

The research program for nonlinear phenomena outlined above is summarized in Table 2.

Theoretical Case Studies

There are two recent results in plasma physics that indi-

Table 2
SUMMARY OF RESEARCH PROGRAM FOR
NONLINEAR PHENOMENA

Title of Program	Approximate Expenditures fiscal year 1978 (in millions of dollars)		Approximate number of man years required
	Operating	Capital	
Microdiagnostics	7.0	4.5	100
Theoretical studies	5.0	—	100
Computer and Numerical work	4.0	30.0	60
Experimental research			
Large plasma focus	2.0	20.0	30
Rings and plasmoids	2.0	10.0	30
Tokamak diagnostics	1.5	1.0	20
Astrophysics	4.0	30.0	60
Total	\$25.5	\$95.5	400

of the magnetic fields. In addition, the details of the longitudinal electric fields are critical for determining the plasma processes, but as yet have been measured only rudimentarily. A great deal of money is required to launch such satellites and for their terrestrial support facilities.

Second, a series of experiments on plasma phenomena in the magnetosphere show amplification of very low frequency EM radiation by factors of 10^3 and energy that then precipitates particle fluxes with energies of 10^6 times the exciting signal. These experiments by the Stanford group at the Antarctica Siple Station must be supplemented by satellite data.

Fluids Finally, although the impact of the study of nonlinear phenomena in other fields has been minimal up to this point, it should not be ignored. To be specific, research

cate the directions and flavor for the kind of research program I have described here. The first is an article by G. Lamb on the connections between solitons and vortex phenomena which appeared in *Physical Review Letters* in August 1976. Qualitatively, these two types of structure in a plasma are the most remarkable of self-organized behavior. Lamb shows a profound connection between the geometry of vortex filaments and solitons.

The physical mechanisms between these two kinds of phenomena are entirely different. The magnetohydrodynamic structures like vortices come out of the motion of the heavy component of the plasma, the ions, and seem in fact to depend on electrons in an entirely unimportant way. The wave motion that is associated with these structures (ion acoustic waves and Alfvén waves) have a slow time variation, and the

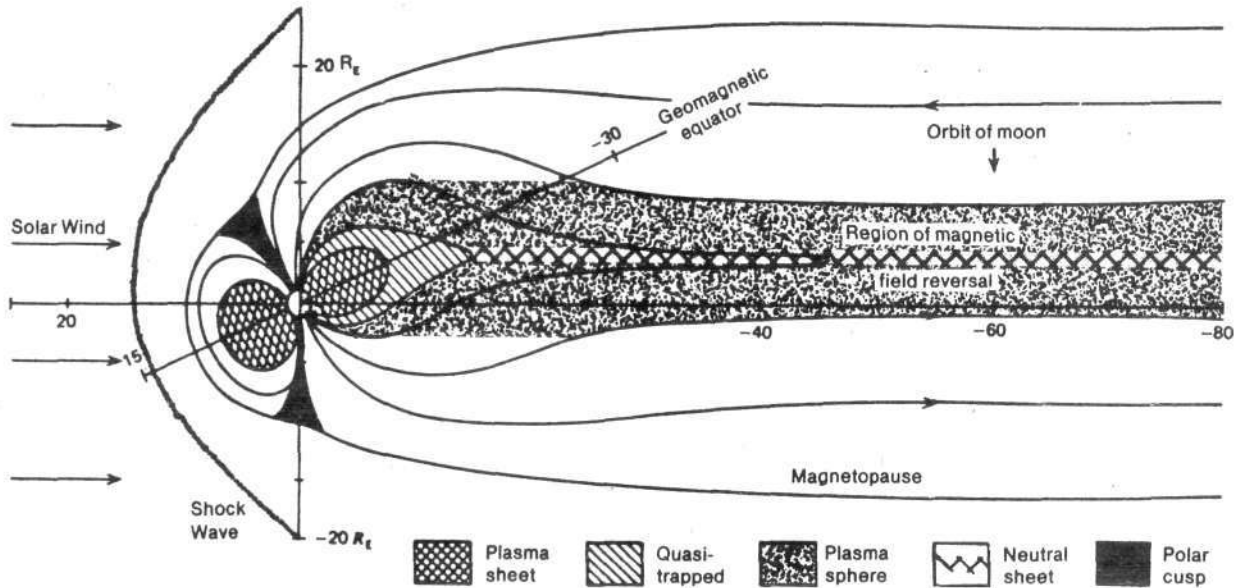

Figure 4

The plasma that surrounds the earth can be schematically drawn showing the divisions between the various plasma layers. The solar wind (the plasma expelled by the sun) is shown on the left, and the solid lines indicate the earth's magnetic field as it interacts with the plasma layers. Distances are marked on the diagram in units of the earth's radius.

time scale of the phenomena tends to be relatively long. In the case of the solitons, however, the ions can be thought of as stationary, and the important dynamics come from the much more rapid motion that the electrons, being much lighter, undergo; the waves and other collective modes of the plasma in this regime (Langmuir waves) are rapidly varying.

In spite of this deep physical difference, both kinds of plasma dynamics, the magnetohydrodynamic and electron regimes, give rise to self-organized structures in a hot plasma. This fact has been a persistent difficulty in understanding the significance of solitons, vortices, and their relatives: what could be the fundamental connection between phenomena which are qualitatively similar (in that they are both examples of self-generated structure that a plasma creates), but which have totally dissimilar physical origins? What kind of property of the plasma are they evidence of? Or perhaps, is it only accidental that both occur, and is it a kind of anthropomorphism that they would be thought similar at all?

Lamb's work makes an important first step in answering these questions, for he has shown that there is a systematic connection between vortices and solitons, at least in fluids, and, more important, he has identified the underlying feature of the fluid that creates this connection between solitons and vortices — the intrinsic geometry of the fluid motions.

The nonlinear Schrödinger equation (NLSE) describes the soliton-like behavior of the self-focusing instability in laser propagation and the modulational instability of Langmuir turbulence in plasmas for example. In standard form the NLSE for wave amplitude ψ is

$$i\psi_t + \psi_{ss} + 2|\psi|^2\psi = 0, \quad \psi_t \equiv \frac{\partial \psi}{\partial t}.$$

This one complex equation can be reduced using the transformation

$$\psi = \frac{1}{2}K e^{-i\phi}$$

to give two real equations

$$K_t + 2TK_s + K\tau_s = 0$$

$$\tau_t + 2T\tau_s = KK_s + \frac{1}{2}(K_{ss}/K)_s$$

where:

$$\tau = \phi_s$$

In nonlinear optics, there are two well-known solutions:

a plane wave K_0, τ_0 — constants

$$\psi = \frac{1}{2}K_0 \exp\{i[\tau_0 s - (\tau_0^2 - \frac{1}{2}K_0^2)l]\}$$

(this is unstable to self-focusing) and the formation of solitons, of the form

$$\psi = \frac{1}{2}K_0 \operatorname{sech}\left[\frac{1}{2}K_0(s - 2\tau_0 l)\right]$$

$$\exp\{i[\tau_0 s - (\tau_0^2 - \frac{1}{2}K_0^2)l]\}.$$

The most powerful method for attacking the soliton solutions of the NLSE and some other nonlinear partial differential equations is to use the inverse scattering method, which reduces the NLSE to a set of linear equations that were first written down by V. Zakharov and A. Shabat

$$i \begin{pmatrix} v_1 \\ v_2 \end{pmatrix} = \begin{pmatrix} -\tau_0 & -i\psi^* \\ i\psi & \tau_0 \end{pmatrix} \begin{pmatrix} v_1 \\ v_2 \end{pmatrix}$$

With this background, we want to show the following, and, in so doing, account for what has been up until now an almost accidental connection between the soliton and its inverse scattering problem (See Scott et al. for a description of the difficulty of getting from the NLSE to the Zakharov-Shabat equations, for example, and for the very obscure physical significance of the transformations that generate the Zakharov-Shabat):

Examine the dynamics of a vortex filament H. Hasimoto showed that the equation governing the time evolution of the curvature and torsion of a vortex filament is the NLSE. That is, a vortex filament, studied in terms of the intrinsic geometry of the filament as a space curve, obeys the NLSE. The plane-wave solution to the NLSE where the curvature is constant and the torsion zero, corresponds to a smoke ring. The soliton solution corresponds to a loop of helical motion (See Figure 6) which rotates with a constant angular velocity and propagates with a constant velocity.

Lamb's contribution is the derivation of a simple geometrical argument that results in the Zakharov-Shabat equation. It turns out that there is a trivial integral of the NLSE when expressed in the intrinsic coordinates of a space curve that reduces the NLSE to the two coupled linear equations.

The classical treatment of vorticity and the concept of a vortex filament is due to Helmholtz. If the vorticity ($\nabla \times \mathbf{v}$) of a fluid is parallel in some localized region of a fluid, and if it is continuous, then we can speak of a vortex filament. This corresponds to our usual idea of a vortex — a tornado, the swirl of draining water and so forth. The vortex filament is a space curve whose dynamics we want to follow.

Notice that we are using a singularly felicitous union of geometry and physics here — the evolution of a geometric entity is being studied, and the geometry to be used in studying the motion of the structure is determined by the motion itself (See Riemann). In the intrinsic geometry of the space curve (the vortex filament), the soliton-like solution becomes evident.

When we distinguish between the fluid velocity, \mathbf{v} , and the velocity of the vortex filament \mathbf{V} , Arm's equation from fluid mechanics says

$$\mathbf{V} = \frac{\partial \mathbf{x}}{\partial t} = \kappa \mathbf{b}$$

The vortex filament travels perpendicular to the vorticity, with a magnitude proportional to the curvature. Its motion will be nondeforming (that is, remain in a given plane) only if the curvature is constant along the filament. Thus, a smoke ring propagates without deformation perpendicular to its vorticity.

This equation supplies the dynamics of the filament. Now, following R. Betchov (1965) and Hasimoto, we want to write this equation in the intrinsic coordinates of the space curve defined by ω , namely the curvature, κ , and torsion. To do so,

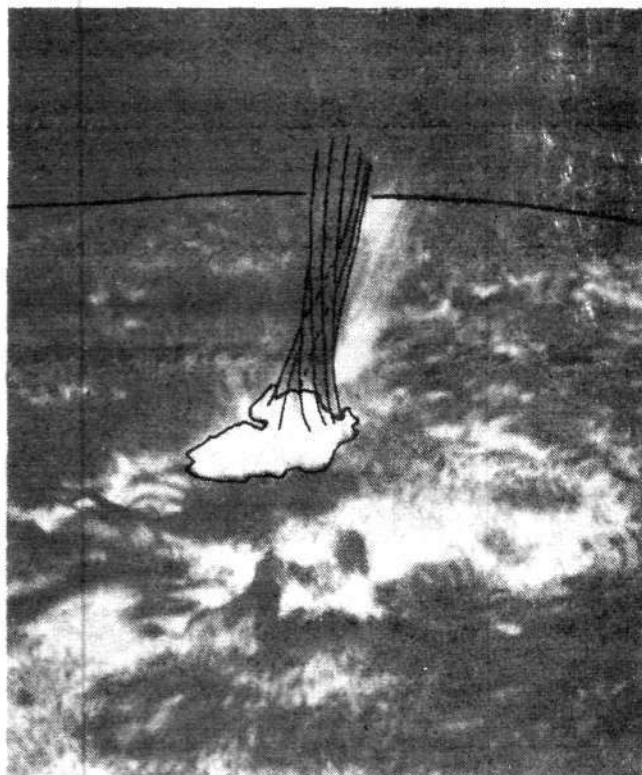

Figure 5

This line drawing emphasizes the vortex filament-type structure in a solar flare.

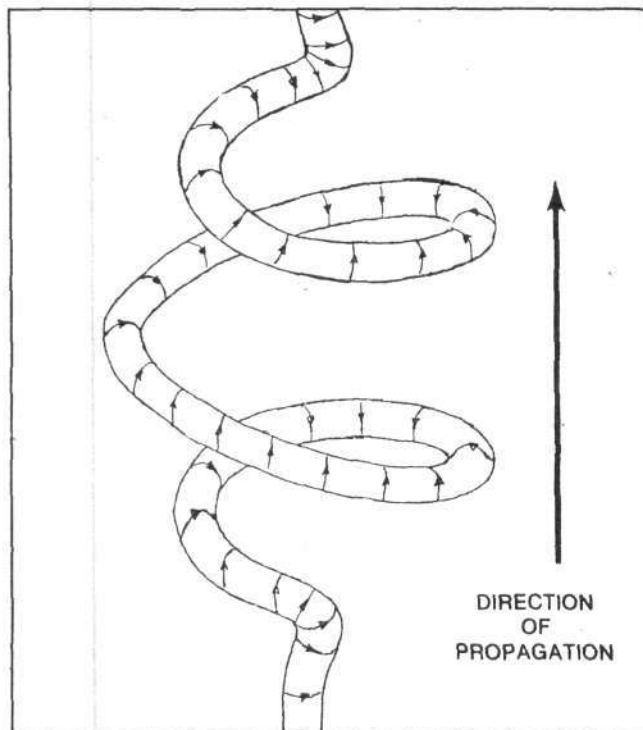

Figure 6

Artist's rendition of soliton propagating on vortex filament.

we use the standard vector analysis of a space curve, in the form of the Frenet-Serret equations

$$\mathbf{t}_s = \kappa \mathbf{n}$$

$$\mathbf{n}_s = -\kappa \mathbf{t} + \tau \mathbf{b},$$

$$\mathbf{b}_s = -\tau \mathbf{n}$$

where the definitions hold that

$$\kappa = \left| \mathbf{x}_{ss} \right|$$

$$\tau = \mathbf{x}_s \cdot \frac{(\mathbf{x}_{ss} \times \mathbf{x}_{sss})}{|\mathbf{x}_{ss}|^2}$$

There are now three steps in the solution:

(1) Write the Frenet-Serret equations in complex form, in analogy with a wavelike solution.

(2) Use Arm's equation to determine the dynamical behavior of this wave; this turns out to be the NLSE.

(3) Use a simple first integral of the Frenet-Serret equations, which follows from the geometry of three orthogonal unit vectors, to transform the NLSE into the Zakharov-Shabat equations. This transformation now has a simple geometrical significance. Multiplying and adding a suitable combination of the Frenet-Serret equations, we have

$$(\mathbf{n} + i\mathbf{b})_s = -\kappa \mathbf{t} + i\tau(\mathbf{n} + i\mathbf{b})$$

and with the definitions

$$\mathbf{N} = (\mathbf{n} + i\mathbf{b}) e^{i\varphi}, \quad \varphi_s = \tau$$

we have the following

$$\mathbf{N}_s = -\kappa \mathbf{t} e^{i\varphi} = -2\mathbf{t}\psi, \quad \text{where } \psi = \frac{1}{2}\kappa e^{i\varphi}$$

With this change of variables, the first of the Frenet-Serret equations becomes

$$\mathbf{t}_s = \psi^* \mathbf{N} + \psi \mathbf{N}^*$$

A straightforward manipulation of this equation and its counterparts for \mathbf{N}_s , \mathbf{N}_t , \mathbf{t}_t gives $i\psi_t + \psi_{ss} + 2|\psi|^2\psi = 0$.

* complex conjugate.

This is the nonlinear soliton equation, now expressed in terms of the intrinsic coordinates of the vortex filament

$$\psi = \frac{1}{2}\kappa e^{i\varphi}, \quad \varphi_s = \tau$$

The equations for \mathbf{N}_s , \mathbf{t}_s , \mathbf{N}_t , \mathbf{t}_t are

$$\mathbf{N}_s = 2\psi \mathbf{t}_t - 2i\tau_0 \mathbf{N} \quad (1)$$

$$\mathbf{t}_s = \psi^* \mathbf{N} + \psi \mathbf{N}^*$$

$$\mathbf{N}_t = 2i|\psi|^2 \mathbf{N} - 2\tau_0 \mathbf{N} + 2i\psi_s \mathbf{t} - 2\tau_0 \psi \mathbf{t}$$

$$\mathbf{t}_t = -i\mathbf{N}\psi_s^* + \tau_0 \mathbf{N}\psi + i\psi_s \mathbf{N}^* - \tau_0 \mathbf{N}^* \psi_s \quad (2)$$

These equations give the spatial and time dependence of \mathbf{t} and \mathbf{N} . We have 18 equations: three for the components of \mathbf{t}_s , three for the components of \mathbf{N}_s^* , three for the components of \mathbf{N}_s , and another nine for the time derivatives of \mathbf{t} , \mathbf{N} , and \mathbf{N}^* . Since \mathbf{n} , \mathbf{b} , and \mathbf{t} are unit vectors, the orthogonality and normality give an immediate integral of each component of equations (1) and (2). Note that the components decouple

$$\mathbf{N} \cdot \mathbf{N}^* + |\mathbf{t}|^2 = 1 \quad \text{or} \quad n_\alpha^2 + b_\alpha^2 + t_\alpha^2 = 1$$

This, geometrically, restricts motion according to the system (2) to the surface of a sphere of radius one in

$$n_\alpha - b_\alpha - t_\alpha$$

space. It is then natural to change the variables in (1) and (2) to take advantage of this. An inversion

$$\frac{N_\alpha}{1 - t_\alpha} \equiv \frac{1 + t_\alpha}{N_\alpha^*} \equiv q$$

for each scalar component (do not confuse v with \mathbf{v} , the fluid velocity, or this t with time) gives a Riccati equation for q

$$q_s = \psi + \psi^* q^2 - it_0 q$$

Similar equations follow from (2). The classic way of dealing with a Riccati equation is with the transform

$$q = v_1/v_2$$

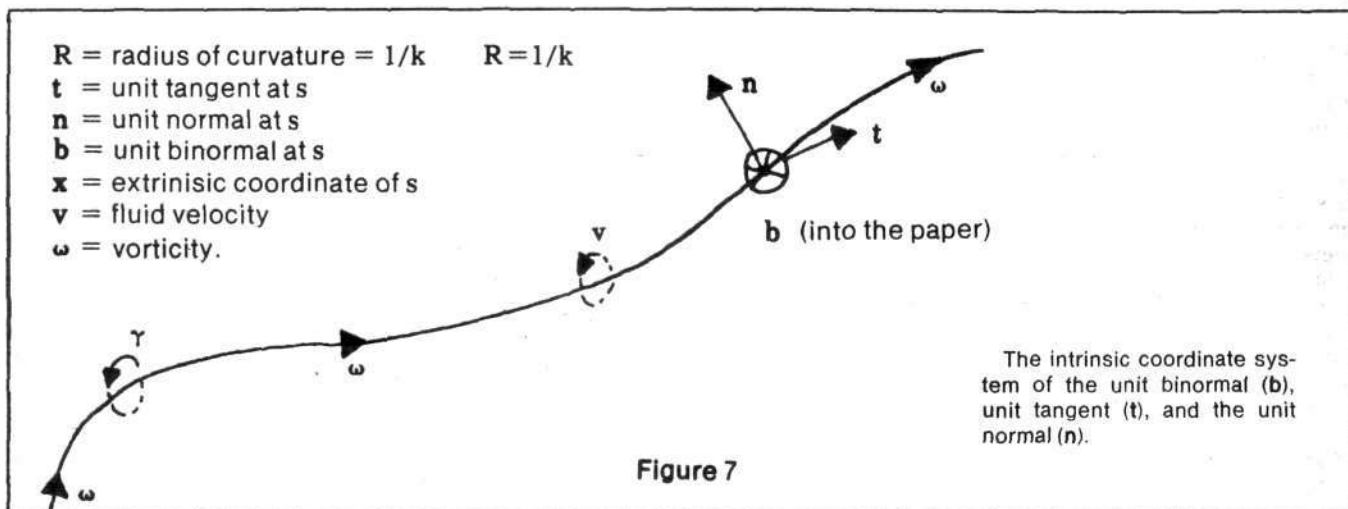

Table 3

SYMMETRIES OF MAGNETOHYDRODYNAMIC FLUID

Symmetry	Conserved Quantity	Lie Group Generator	Current Density
Geometric Lorentz space time	momentum energy	Λ H	— —
Dynamic Gauge	(flows with fluid)		
\mathbf{v}	$\int \mathbf{A} \cdot \mathbf{v}$	$\Lambda \cdot \nabla$	$\mathbf{E} \times \mathbf{A} + \phi \mathbf{B}$
\mathbf{B}	$\int \mathbf{A} \cdot \mathbf{B}$	(mag. helicity)	—
\mathbf{A}	$\int \mathbf{B} \cdot \mathbf{v}$	(cross helicity)	—

which, when applied to these Riccati equations gives the following two *linear* systems; that is, the above transformations change the nonlinear system into a linear system

$$i \begin{pmatrix} v_1 \\ v_2 \end{pmatrix}_s = \begin{pmatrix} -\tau_0 & -i\psi^* \\ i\psi & \tau_0 \end{pmatrix} \begin{pmatrix} v_1 \\ v_2 \end{pmatrix}$$

$$i \begin{pmatrix} v_1 \\ v_2 \end{pmatrix}_t = \begin{pmatrix} |\psi|^2 + \tau_0^2 & -\psi_s^* + i\tau_0\psi^* \\ -\psi_s - i\tau_0\psi & -|\psi|^2 - \tau_0^2 \end{pmatrix} \begin{pmatrix} v_1 \\ v_2 \end{pmatrix}$$

The first of these are the Zakharov-Shabat equations, well known from the inverse scattering theory of the nonlinear soliton equation; the second is the associated Lax formalism.

Lamb's contribution was the derivation of the above pairs of coupled linear equations from geometrical considerations that become evident in the intrinsic geometry of the vortex filament. This connection between the intrinsic geometry of a vortex filament and singular soliton phenomena seems key.

Lamb's work raises more questions than it answers: What happens when the filament is characterized by more complex dynamics than those of Arm's equations (like the magnetohydrodynamic equations). What is the relation between solitons and the physical vortex filaments in a plasma? What insight does this provide into the problems of the interaction of several solitons or the autodestruction of a pair of counterrotating vortex filaments? In any case, Lamb's work and work that it has inspired in others (Regge and Lund, for example) is the sort of insight into nonlinear structure that is critical for future development. So far, however, this work has dealt only with the Riemannian aspect of the concept of nonlinearity; the question of a Cantorian-like change in geometry is still unapproached.

Hydrodynamic Structures

The other line of theoretical work I will describe is on the dynamics of hydrodynamic structures in a plasma. The second in this three-part series on plasma physics included an analysis of the work of Dan Wells at the University of Miami concentrated on the experimental and theoretical work his group did on the steady state behavior of smoke rings of plasma and magnetic field produced by a plasma moving across a magnetic field. In the past several years, Wells's work on his theory has produced a formalism that describes the evolution of these structures and their dependence on the geometry of the boundaries. It is worth reviewing in outline the methodology that Wells used to arrive at an equation for the fields of the smoke ring, since he drew on a number of concepts from field theory and used the concepts of symmetry-breaking and global geometrical considerations in an essential way.

Wells begins with the magnetohydrodynamic equations describing the plasma and draws from this a classical Lagrangian density due to the Canadian physicist Calkin. This Lagrangian is important not because it recreates the equations of motion, but because it gives in explicit form the symmetries of the plasma motion in its full nonlinear generality. According to classical field theory, a specification of the Lagrangian allows four interconnected concepts to be laid out:

- 1) a *symmetry* (a transformation of either coordinates or field variables that does not change the equation of motion);
- 2) *Noether's Theorem* which states that there exists some quantity, associated with each of these symmetries, that is conserved by any motion that the system undergoes (classically, for example, the invariance of the equations of motion under translations in space assures that momentum is conserved);
- 3) a *Lie group* which generates this transformation (giving, essentially, the derivatives, in the geometric sense, of the symmetry);
- 4) and a *current density* (the conservation of the quantity

allows a conservation equation to be written down that relates the time rate of change of the conserved quantity to its sources. This equation must be satisfied at each point of the fluid).

These relations for a perfect magnetofluid are described schematically in Table 3.

The question of the completeness and uniqueness of this set is difficult, but the current density representation allows us to tackle it. For a perfect fluid, these are complete, but, more important, for a slightly imperfect fluid, these conserved quantities generate a complete set of functions that provide a description of the degree of nonconservation. Specifically, it is possible to write an equation of the following form for each symmetry

$$\frac{\partial}{\partial t} \int f(t) \mathbf{A} \cdot \mathbf{B} = \nabla \cdot$$

$$\int f(t) \{ \mathbf{E} \times \mathbf{A} + \phi \mathbf{B} \}$$

where $f(t)$ is determined by the boundary conditions and the degree to which they break the symmetry. Each new constraint on the system (for example the question of the conservation of angular momentum) specifies a form for $f(t)$ and thus determines the evolution and energy of the resulting structures.

For the class of collinear (\mathbf{v} and \mathbf{B}) structures which Wells observes in the laboratory, the generator projects out of all stable states those which are collinear as follows:

$$G | \mathbf{B} \rangle_{\text{all}} = | \mathbf{B} \rangle_{\text{collinear}},$$

$$G = - \frac{i}{\kappa} \frac{\Lambda \cdot \nabla}{f(t)},$$

$$| \mathbf{B} \rangle = (i + \beta) \begin{pmatrix} B_x \\ B_y \\ B_z \\ 0 \end{pmatrix}$$

where

$\Lambda =$ Lorenz matrices

$$\nabla \times \mathbf{B} = \kappa \mathbf{B}$$

$$\mathbf{V} = \pm \beta \mathbf{B}$$

Clearly, if $f(t)=1$, the structure either will exist forever or cannot decay. However, when $f(t)$ is different from 1, then evolution becomes possible, according to an equation reminiscent of those of quantum and classical field theory

$$| B(t) \rangle = \exp[\nu (\Lambda \cdot \nabla)^2 (t - t_0) / f^2(t)] | B(t_0) \rangle.$$

This is a striking result, for it allows a deterministic evolution of an ordered structure to be computed from the boundary conditions and broken symmetries of the experimental setup. As with Lamb's work described above, the welding of geometry and dynamics is very close here; in this sense, Wells has provided a Riemannian treatment of nonlinearity.

Although Wells's work has not been published, it provides the basis for both extensive theoretical work and numerical testing. The experimental evidence of these self-generated structures in a plasma more and more demands the use of the geometric connections developed by Lamb and Wells. A research program on nonlinearity makes this possible.

Suggested Readings

- Arms, R.J., Hama, F.R. 1965. *Phys Fl* 8: 553.
 Bardwell, S. 1976. *FEF Newsletter* 2: 19.
 Betchov, R. 1965. *J. Fl. Mech.* 22: 471.
 Calkin, M. 1963. *Canadian J. of Phys.* 41: 2241.
 Cantor, G. 1883. "Foundations of a General Theory of Manifolds." 1975), p. 69.
 Haken, H. 1975. *Rev. Mod. Phys.* 47: 67.
 Helliwell, R. 1975. *Phil. Trans. A.* 280: 137.
 Lamb, G.L. 1976. *Phys. Rev. Lett.* 37: 235.
 Levitt, M. 1976. *FEF Newsletter* 2: 3.
 Lund, F., Regee, T. 1976. *Phys. Rev. D.* 14: 1524.
 Montgomery, D., Joyce, G. 1974. *Phys. Fl.* 17: 1139.

- Parpart, U. 1975. "The Concept of the Transfinite." *The Campaigner* (January-February 1975), p. 6.
 Prigogine, I. "Introduction to Nonequilibrium Statistical Physics." *Topics in Nonlinear Physics* (New York: Springer-Verlag, 1968).
 ———. *Advances in Chemical Physics* 31 (New York: Academic Press, 1975).
 Riemann, G.F.B. 1853. "Fragments." *The Campaigner* (January-February 1975), p. 98.
 Ruelle, D. *Rigorous Results in Statistical Mechanics* (New York: W.A. Benjamin, 1969).
 Scott, A.C., Chu, F.U., and Mclaughlin, D.W. 1973. *Proc. IEEE* 61: 1443.
 Tsytovitch, V.N. 1976. *Physica* 82C: 141.
 Wells, D. 1974. "The Current Algebra of Global MHD Stability." Unpublished report, University of Miami, MIAPH-PP-70.13.
 Zakharov, V., Shabat, A. 1972. *Sov. Phys. JETP* 34: 62.

About the Authors



Dr. Steven Bardwell heads the plasma physics section of the Fusion Energy Foundation. A 1971 graduate of Swarthmore College, Bardwell received a PhD in plasma physics from the University of Colorado at Boulder in 1976.

Bardwell's thesis research was on the theoretical treatment of the interaction between intense electric fields and plasmas. He has produced several papers based on this research. Four of these papers were delivered at meetings of the American Physical Society, one at the last meeting of the International Geophysical Society, and one was recently published in the *Journal of Astrophysics* (Three-Dimensional Langmuir Wave Instability in Type Three Solar Radio Bursts).

In the past month, Bardwell has lectured extensively throughout the Midwest to university and industrial audiences on fusion power. He is currently continuing research on the self-organizing phenomena that appear in plasmas and the implications of this research for contemporary physics.

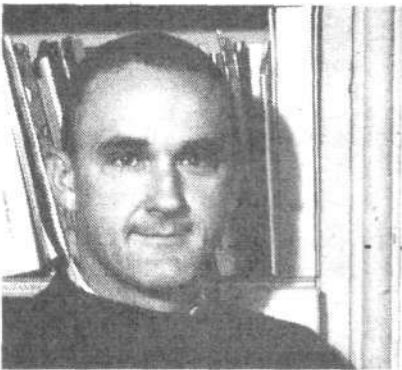

Jon Gilbertson is a nuclear engineer and one of the top nuclear plant safety analysts in the United States. He has over 15 years experience in nuclear safety and design, primarily on liquid metal fast breeder reactors and on pressurized water-cooled reactors. Reactors fueled with plutonium were a central feature in many of the design studies that Gilbertson either participated in or managed. He also holds a patent on a tested nuclear reactor safety shutdown system.

Since he received his master's degree in nuclear engineering from the University of Wisconsin in 1962, Gilbertson has authored a number of technical reports for the U.S. government and industry, and has published in the journal *Nuclear Technology*.

He is now working on a long range study for the Fusion Energy Foundation on the retooling requirements of U.S. industry in the transition to a fusion-based economy.

Human Survival Depends On Nuclear Power

Jon Gilbertson

Both the *Wall Street Journal* and the *New York Times* published feature articles Dec. 1 advertising a report by the U.S. government's General Accounting Office as evidence that the breeder reactor component of this nation's nuclear energy program was properly on its way to the scrap heap. "GAO Says Ford Plutonium View Perils Future of Breeder Reactor," headlined the *Times*, referring to an Oct. 28 decision by the president to delay commercial use of plutonium in nuclear reactors. (1) The *Wall Street Journal* added, "although the GAO report didn't say so, the breeder's future also is made uncertain by the election of Jimmy Carter. The President-elect, during his campaign, criticized the breeder program and also had views similar to Mr. Ford's in questioning the use of plutonium by the nuclear industry. It is probable Mr. Carter will propose that Congress drastically reduce the funding for the breeder program, or perhaps even kill it." (2)

These and similar press accounts are intended to further legitimize the widely believed (and totally false) notion that increased plutonium use and nuclear fission generally represent a danger to humanity. Purposefully ignored in such accounts is the evidence that the elimination of plutonium as a nuclear fuel will mean the demise of the entire U.S. nuclear power industry and ultimately the human race itself. At stake in the short term, in addition to the breeder reactor program, is the well established use of light water reactors for generating electricity, since these must, within a matter of years, be fueled with plutonium as the limited reserves of their current fuel, uranium, run out.

The attack on nuclear fission programs is also directed at the more advanced, more capital-intensive nuclear fusion technology, since the elimination of fission programs will wipe out the trained cadre force of engineers, scientists, technicians, and skilled workers needed to develop fusion power.

The growth of fission power over the next two decades is absolutely necessary for the transition to a full fusion-based economy. Only nuclear fusion has the inherent capability of transforming industry to the necessary higher mode of production and output, as well as providing a limitless source of usable power in several forms, that is, thermal, electrical, radiative, and charged particles, thus insuring the survival of the human race beyond this century. Fission power and conventional fossil power must be expanded and possibly even exhausted during this transition in order to guarantee the achievement of this goal.

Current predictions of available world uranium reserves used as fission fuel (excluding the Soviet Union and the socialist bloc) indicate that economically viable ore (at less than \$20 per pound of U_3O_8) will run out within approximately 15 years at even current rates of energy growth, while inclusion of the less certain reserves of more expensive ore (\$40 to \$40 per pound of U_3O_8) probably won't last until the end of the century. This means that nuclear reactors being built now will run out of uranium fuel long before their design lifetime of 30 years is completed. This fact is well known by those in the nuclear industry as well as the bankers who control capital investment.

Plutonium must be available in the near-term to fuel light water reactors and to insure that they are an economically viable energy source; otherwise the most technologically advanced industry in the U.S. will disintegrate, and with it, the potential for human survival.

Why Attack Plutonium

The campaign against plutonium is being carried out for two major interrelated reasons. The first involves the commitment of the principle New York financial institutions backing Carter to a public works labor-intensive "pick and shovel" economy typified by such Carter programs as the Humphrey-Hawkins jobs bill and proposals for a regional "Big MAC" in the northeastern U.S., both of which envision such relatively primitive operations as coal gasification, shale oil and wood-burning as major "alternate energy" programs. Nuclear energy, requiring high capital investment and a highly skilled workforce, is, from this standpoint, a dangerous interference with the monetarist financiers' plan to collect their debt. The anti-fission activities of Ralph Nader, various environmentalist groupings, and the public watchdogs of the Eastern press — in short, the entire Carter coalition — should be understood in that light.

Second, to the extent that nuclear power is still seen as operative in the short term, these same financiers want to establish total control over the nuclear fuel market as a means of procuring additional temporary liquidity with which to prop up the dollar debt system. At present a massive joint effort by the two leading financial powers, the Rockefellers and the Rothschilds, is underway to buy up controlling interests in the entire world's supply of uranium ore. Their essential goal is to be able to fix the uranium ore price at any arbitrary high level, creating "uranium hoaxes"

1. *New York Times*, 1 December 1976, p. A 18.

2. *Wall Street Journal*, 1 December 1976, p. 18.

What you should know about the hazards of nuclear power



US UNION OF CONCERNED SCIENTISTS

AFTER YOU READ THIS LETTER, PLEASE TAKE A MOMENT TO INDICATE YOUR RESPONSES ON THE ENCLOSED SURVEY FORM AND RETURN IT IN THE POSTAGE-FREE ENVELOPE PROVIDED. THERE IS NO OBLIGATION WHEN YOU DO. YOUR OPINIONS ARE IMPORTANT TO US.

Dear Fellow Citizen,

This is to advise you of the grave risk you and other Americans face from nuclear radiation accidents.

... call to hysteria. It's a sober warning from scientists, engineers, biologists, chemists, and other concerned scientists who volunteered their time for this program.

Nader's anti-nuclear raiders and their thousands of environmentalist lawsuits are responsible for increasing the construction time necessary to get nuclear plants on line 130 percent from 1970 to 1976 — from about 4 years to 9 years. In the past two years, there has been a 65 percent reduction in the number of nuclear plant operating licenses and an 85 percent reduction in the number of new plant contracts issued.

similar to the 1973 "oil hoax." Like the petrodollars, these paper profits will be allocated for debt rollover rather than productive investment. (3)

Plutonium is a monkey wrench in the way of such monetarist schemes. Expanded use of plutonium would actually reduce the price of nuclear fuel, since the expensive enriching process for U-235 can be eliminated. Furthermore, the Rockefellers and their ilk would effectively lose their ability to corner the nuclear fuel supply, since plutonium fuel could be generated within the reactors themselves.

Nuclear Power Compared to Conventional

The cost of electricity generated by the established light water reactor power plants compares favorably with that produced by conventional oil and coal fire plants in most parts of the United States and in many countries throughout

the world. In fact, given the currently inflated world price of oil (\$11 per barrel), electrical power from nuclear reactors is much cheaper than oil and also generally somewhat cheaper than coal at the current \$20 per ton rate. A recent economic analysis by Dr. Seymour Baron of Burns and Roe, published in the June 1976 issue of *Mechanical Engineering*, and based on a complete net energy balance, best clarifies the current electrical power cost situation (4). (See Table 1.) In addition to standard capital costs, his analysis takes into account the cost of all energy, both electrical and thermal, required to mine and process fuel, produce materials of construction, and construct and operate the power plant, as well as the energy efficiencies and net energy output.

Results of this study show that even based on noninflated, real production fuel costs — oil at \$1.35 a barrel, coal at \$3.00 per ton and uranium at \$8.00 per pound of U_3O_8 — all three means of producing electricity are economically comparable

3. U.S. Westinghouse Corp. has filed an antitrust suit against 29 U.S. and foreign uranium producers charging that they have illegally fixed prices in order to control the world market and edge Westinghouse out. These producers are connected to Rockefeller and Rothschild banking concerns and there is evidence that they deliberately set up the situation to speed the demise of nuclear power. See *Nuclear Engineering*

International, November 1976, p. 16 for a report on the Westinghouse suit and the New Solidarity International Press Service *Executive Intelligence Review*, Jan. 25, 1977, pp. 13-14 for an analysis of how and why the situation was set up.

4. "Energy Cycles: Their Cost Interrelationships for Power Generation," pp. 22-30.

Table 1
COMPARISON OF COST AND PRICE OF DELIVERED ELECTRIC POWER

	Total Energy Costs (mills per kw hr) (1)	Total Energy Price (mills per kw hr) (2)	Approximate 1975 Fuel Prices (3)	Capital Investment (billions of dollars)	Energy Pay off Time (years)	Net Cycle Efficiency (percent)
Oil	25.1	45.7	11	0.94	0.2	26.6
Coal	24.2	31.7	20	0.97	0.2	32.4
Coal Gas	41.7	55.7	20	1.67	0.4	17.5
Coal Liquid	46.3	58.8	20	1.87	0.5	19.4
Light Water Reactor	27.8	28.5	20	1.16	0.4	24.9
Liquid Metal Fast Breeder Reactor	33.7	33.9	20	1.43	0.4	34.7
Fusion	45.2	45.2	0	1.92	0.4	24.6
Solar Collectors	490.0	490.0	0	20.9	8.3	2.6
Solar Cells	680.0	680.0	0	28.9	48.0	3.9

(1) Real, non-inflated fuel costs
 (2) Fuel costs based on 1975 fuel prices
 (3) Prices are per barrel (oil), per ton (coal, coal gas, coal liquid), and per pound (uranium)
 (4) In 1985 dollars, less fuel costs.

This analysis was done on the basis of a complete net energy balance with all systems producing 1000 megawatts electric. The results represent a useful procedure for comparing electrical energy costs; however a much more in-depth analysis would be needed to accurately compare fusion energy in such a table since its eventual contribution to an industrial society is far greater than that of electricity.

and the choice among them will generally be based on nearness to and availability of the fuel supply. For example, in the New England region of the United States, nuclear power is the clear choice since easy access to either cheap coal or oil is very difficult. In many regions of India, on the other hand, both coal and nuclear power can be considered, since large reserves of both coal and fission fuel are available. Of course, when plutonium becomes readily available, the nuclear option will become cheaper and the relationship between the three resources may change.

Potential near-term advance systems employing the liquid metal fast breeder reactor, and even fusion (which in this analysis was based on a very conservative first cut power plant design — the UMAK-I, Tokamak), look promising even though costs estimates were based on current state-of-the-art technology which, for fusion reactors, would represent gross overestimates.

Although all nine of the alternatives considered by Dr. Baron were calculated based on current state-of-the-art technology, only oil, coal and nuclear power (Light Water Reactors) are in significant use today and, therefore, represent true operating systems based on current technology. A breakdown of current United States energy consumption shows approximately 45 per cent coming from coal, 15 per cent from oil, 10 per cent from nuclear power, and the last 30 per cent split between hydroelectric and natural gas.

Dr. Baron's work on net energy comparisons also exposes the joke foisted on the public concerning the "advantages" of alternate energy schemes such as coal gasification and solar power as major contributions to world energy needs. These results show these schemes' energy costs exceed even the very conservative estimates for fusion power. Gas or liquid fuel produced from coal will result in energy costs al-

most double that of direct use of coal and will wastefully use up coal resources at twice the rate while generating only the same power. Solar power is not even in the same league since energy costs are a factor of 10 to 140 times higher and it requires between 8 and 50 years to simply recover the energy expended in building and operating solar plants.

Nuclear Safety

The great danger of plutonium to the human population has been manufactured by those forces pushing austerity and zero growth. Past and current studies of the real hazards of plutonium have shown that it is not "the most toxic substance known to man," and that in total, it is considerably less of a hazard than the large quantities of many chemicals which are processed and used every day in industry. Although this view is well documented and supported by competent researchers worldwide, it continues to be well hidden from the general public. A recent article by Bernard L. Cohen from the University of Pittsburgh, entitled "Plutonium Toxicity: An Evaluation Indicates It Is Relatively Harmless," provides an excellent review of this issue (5).

Since plutonium is dangerous principally as an inhalent, it is compared in Table 2 with quantities of a few other poisonous inhalents produced in the United States. It should be noted that plutonium is not easily dispersed whereas the others are gases and hence, readily dispersable. Although plutonium will last far longer than these gases, which will decompose chemically, it is also true that nearly all damage done in plutonium dispersal is from the initial cloud of dust and very little from later resuspension by wind or during the years it is buried in the soil. It is clear that plutonium rates low on the danger scale in this comparison.

5. *Nuclear Engineering International*, November 1976, pp. 35-38.

More important is the actual history of the effect on people who have been exposed to plutonium. During the period from World War II through 1974, there have been 1155 cases in the U.S. where people have received significant doses of plutonium. So far, there have been no known deaths attributable to plutonium poisoning, nor have there been any cases of cancer. Included in these statistics are 25 men, some of whom received doses far beyond the current Energy Research Development Administration "maximum permissible body burden," when they worked at Los Alamos scientific laboratory during the war when safety precautions were less stringent. According to the "hot particle" theory which the Naderites and other zero-growth advocates use against nuclear power, each of these men should have experienced an average of 400 cases of lung cancer by now. Instead, they are almost all normally healthy individuals 30 years later; one has died of a heart attack. In 1965, another 25 workers were exposed to large amounts of plutonium in a fire that occurred at the Rocky Flats Colorado Weapons Plant. None has experienced any ill effects. Other cases could also be cited with similar results. (6).

This is not to say that plutonium is not hazardous. On the contrary, it is potentially hazardous as are many other materials; it is currently treated with overwhelming precautions in its handling and use. Because of its well recognized potential danger — it is a long-lived, low-energy, alpha particle-emitter which, if ingested into the human body, has the potential of causing cancer — more is known today about plutonium and its effects than is known about most other substances that we face routinely. Extensive safety procedures and precautions have been developed in handling the material and in preventing its release during fuel processing or following a hypothetical accident in a nuclear power plant. Such precautions are more than sufficient to deal with the potential problems of plutonium.

Nuclear Waste Disposal

Similar to the question of plutonium toxicity, the question of nuclear disposal is a legitimate one, but it is primarily an issue of providing the appropriate engineering design measures in processing, handling, transporting, and storing radioactive material in order to insure that proper safety precautions are met. Contrary to current general public belief, the problem of waste disposal is not related to the quantity of waste; it is simply to insure the isolation of waste from the human environment for long periods of time — hundreds of thousands of years. This makes it a rather straightforward engineering and materials problem which for all practical purposes is already solved.

Table 3 illustrates the amount of consumption and waste from a 1000 MWe nuclear plant compared to that of a coal plant. The tremendous magnitude of difference is obvious. It is clear that the amount of waste from the nuclear plant is very small compared to the energy obtained. Putting it another way, it is estimated that all the nuclear waste that will be generated in the United States by the year 2000 could fit into a cube about 250 feet on a side, and of that, the "high level wastes" would occupy a cube about 50 feet on each edge.

6. See W.J. Blair, C.R. Richmond, and B.W. Wachholz, "A Radiobiological Assessment of the Spatial Distribution of Radiation Dose from Inhaled Plutonium," WASH-1320, U.S. Atomic Energy Commission (September 1974).

Isolation of this waste from the environment is done now and for the foreseeable future by underground storage in leak-proof tanks. For the first few months the waste is stored within the spent fuel inside the reactor building. It is then processed where reusable fuel, U-235 and Pu-239, is separated from the fission product waste, and the waste is stored as a concentrated liquid in underground tanks for five years. These tanks are now constructed with double-walled, impervious stainless steel and encased in concrete. Included are foolproof leak detection equipment, heat removal capacity and readily available spare tanks to which any filled tank could be emptied should a leak between the first and second wall occur. Simple engineering!

All older single wall design tanks such as those that were built after the war at Hanford, Washington are being replaced with modern equipment. Some of these older tanks started leaking in the early 1970s and although the nuclear critics howled and predicted the "end of the world" there was no danger to the public nor is any expected. The waste material was trapped in the surrounding rock and hardpan layers and did not enter the ground water table, a major consideration in locating the tanks there in the first place.

Finally, after five years of storage in these tanks, the decay heat levels are low enough so the waste can be concentrated even further, solidified by recently developed processes and stored essentially forever in underground vaults that are permanently removed from the human environment. To falsely assume that man has not advanced technologically since the 1940s and cannot today design and build a storage system that will completely contain safely and per-

Table 3

LETHAL INHALATION DOSES PRODUCED ANNUALLY IN THE UNITED STATES (10^{12})

Chlorine	400
Phosgene	18
Ammonia	6
Hydrogen Cyanide	6
Plutonium	1

(This assumes all U.S. power is from fast breeder reactors)

FUEL CONSUMPTION AND WASTE — 1000-MEGAWATT POWER PLANT*

	Hourly	Daily	Annual
FUEL CONSUMPTION			
Coal	690,000 lbs.	8,300 tons ^a	2,300,000 tons
Uranium	0.3 lbs.	7.4 lbs.	about 1 ton
WASTE PRODUCTION			
Coal (ashes)	69,000 lbs.	830 tons ^b	230,000 tons
Uranium (total)	2.7 lbs.	64 lbs.	11.6 tons
High-level fission product waste	0.26 lbs.	6.1 lbs.	1.1 tons
Other waste	2.4 lbs.	58 lbs.	10.5 tons

*1000 megawatts is enough electricity for a city of about 1 million people

^a Equivalent to a 100-car trainload every day

^b Equivalent to a 33-car trainload every day (not including airborne wastes)

The three nuclear power plant systems shown schematically here illustrate not only a progression in technical complexity but, more important, a continual increase in energy density, and thus of energy throughput for society as a whole. Although not shown here, coal- or oil-fueled power plants would fall well below the pressurized water reactor in this progression.

Each nuclear plant in this illustration produces the same amount of electricity — 1,000 megawatts electric (MWe) — but the higher technology systems contain inherent advantages over their simpler counterparts.

The **pressurized water reactor** is one of several systems classified as light water reactors, which are the primary type of nuclear plant currently operating or being built in the U.S. and elsewhere in the world. Nuclear energy in the form of heat is transferred from the fuel in the reactor, via a pressurized circulating water loop, to a steam generator-turbine system. Electricity supplied to a utilities transmission grid is the end product. However, over the three- to four-year life of the fuel elements, some fission fuel is produced in the reactor in the form of plutonium, as uranium-238 undergoes nuclear reaction with the neutrons generated out of the fission reaction. This plutonium-239, along with new unburned uranium-235, can be reprocessed and fabricated into new fuel. But thanks to the "great plutonium hoax," this is now being done on a commercial basis.

The **liquid metal fast breeder reactor** operates with much higher-energy neutrons than does the light water reactor and its nuclear energy is transferred to a steam generator-turbine system by a much more efficient coolant, liquid sodium. In addition to a much higher energy density as well as thermal efficiency (40 per cent compared to 30 per cent for the light water reactors), this system is also a much more efficient producer ("breeder") of fission fuel — plutonium. In fact, it produces more fuel than it burns, and therefore over its lifetime can provide enough fuel for itself plus at least one additional reactor. Here high-energy neutrons are absorbed in a uranium-238 "blanket" which is placed around the fuel region specifically for the purpose of breeding plutonium.

The **fusion-fission hybrid reactor** combines the advantages of the liquid metal fast breeder reactor with those a near-term fusion reactor and achieves a potentially even more efficient nuclear power system. The advantages of high energy density and thermal efficiency are inherent. In addition, however, the reactor efficiently employs its dense high-energy neutrons (from the deuterium-tritium fusion reaction) to produce large quantities of both fusion and fission fuel as well as nuclear energy. Fusion fuel — tritium — and fission fuel — plutonium — are produced as neutrons and react with the lithium coolant and uranium blanket respectively. The tritium is continuously used to fuel the fusion reaction of the hybrid reactor while enough plutonium is produced to fuel at least six large fission reactors.

(It should be noted that other factors besides those raised in this brief treatment would determine the overall mix of fission and fossil fuels in the transition to a completely fusion-based economy.)

THE PRESSURIZED WATER-COOLED REACTOR

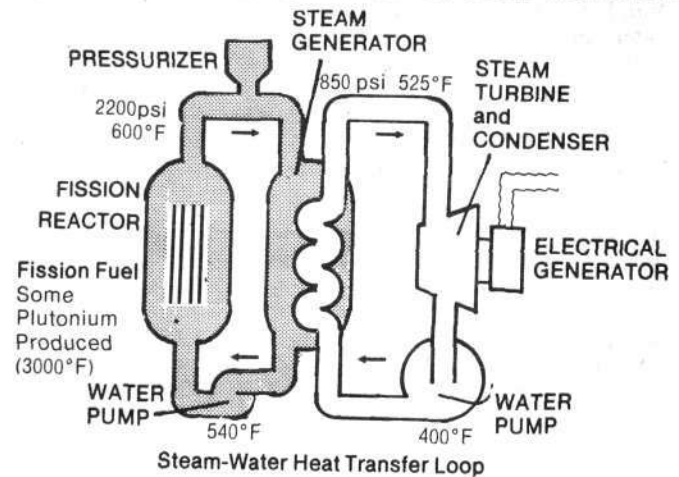

THE LIQUID-METAL-COOLED FAST-BREEDER REACTOR

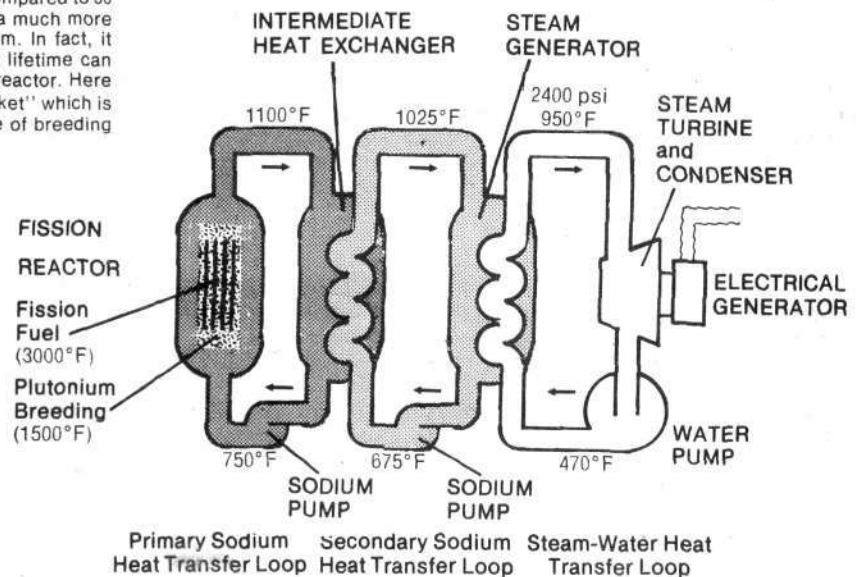

THE FUSION-FISSION HYBRID REACTOR

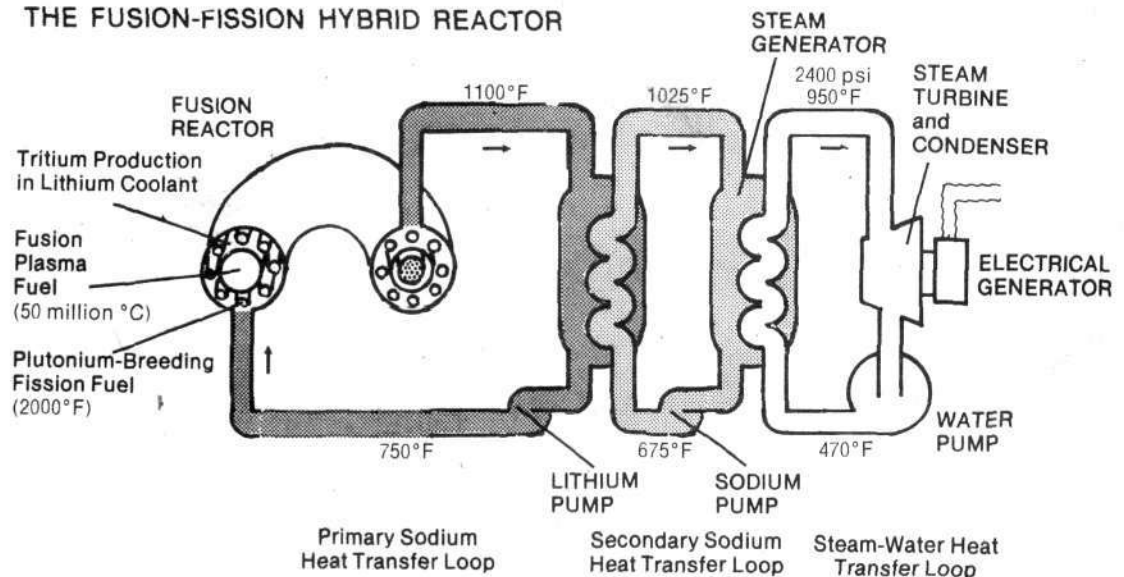

mantly this nuclear waste material is to deny the reality of human progress.

The "Nuclear Reactor is an Atom Bomb" Fairy Tale

A nuclear power reactor cannot explode like an atomic bomb, no matter what Ralph Nader and his crowd preach. Although both may use uranium or plutonium as fuel, there is absolutely no similarity between reactors and bombs. Bombs require the fuel material to be highly enriched and concentrated (50 per cent to 90 per cent) and fabricated as metal into precise, close fitting geometries, while reactor fuel is very dilute (3 per cent), fabricated usually as pellets of uranium oxide stacked in wide-spaced arrays of tubes with cooling water circulating around them. This reactor fuel cannot create an atomic explosion unless it were to be removed from the reactor, reprocessed in a separation plant, concentrated or enriched, changed to metal and machined into parts to an atom bomb. So-called reactor explosions are merely versions of an extremely low probability accident scenario. None has ever occurred nor has there ever been a hint of one occurring. For a Light Water Reactor, this postulated event assumes that somehow a main primary coolant pipe carrying high-pressure water completely ruptures, the water is flashed to steam and all the reactor coolant blows out the containment building. Although the reactor has several built-in emergency core cooling systems which would continue to inject cooling water into the reactor if such an event occurred, it is further postulated that none of these emergency systems works or if they do, water does not enter the reactor core.

Finally, after stripping away as useless all equipment and safety devices that have been designed and built into the plant to prevent any of these failures, these nuclear critics ask, "So now what would you do if?" At this point the reactor core will sit there at shutdown decay heat levels, the fuel rods will melt, maybe into a molten puddle, then perhaps through the reactor vessel, then maybe through the two or three containment barriers and dispersal mechanisms, possibly through several feet of concrete floor and then on through to China! This has historically been referred to by professionals as the "China Syndrome."

Literally thousands of analyses have been performed on currently operating as well as proposed nuclear power plants by all four major reactor manufacturers — General Electric,

Westinghouse, Combustion Engineering, and Babcock and Wilcox — as well as several national labs. All have consistently confirmed that none of the accident scenarios will actually occur. Tests simulating such accidents are already scheduled, and will further demonstrate their impossibility.

Such accident scenarios are like postulating that for some unknown reason, all four engines on a filled-to-capacity Boeing 747 jetliner fail while it is traveling on a non-authorized course and the jet crashed in the Rose Bowl at half-time of the New Year's Day football game.

Nuclear Proliferation and Terrorism

As has been pointed out frequently elsewhere, nuclear terrorism à la "five Palestinians and a shoebox filled with plutonium" is a hoax, as are all "backyard atom bomb" schemes. (7) Nuclear terrorism could in reality in occur if a government handed over a nuclear device, ready made to a so-called "terrorist group." Nuclear terrorism is a political question and must be dealt with on that level.

The question of nuclear proliferation — the distribution of nuclear power plants to other countries and therefore the potential for manufacturing nuclear weapons — is simply a choice between world development for the future or nuclear war sometime in 1977. The Carter "solution," in an article most recently promoted by a Dec. 5 *New York Times Magazine* titled "How Atoms for Peace Became Bombs for Sale," is to withhold nuclear power from other advanced countries and all developing countries and cut back its use across the board everywhere else (8). That is, completely deprive most of the world's population of energy for development, and use solar energy and other equally bad alternatives elsewhere.

Interestingly enough, Carter, the renowned opponent of nuclear proliferation takes a position 180 degrees opposite to his stand against commercial nuclear power by backing "proliferation" of nuclear weapons, specifically "utopian" militarist Admiral Hyman Rickover's plans for a nuclear navy. Nor should it be forgotten that Carter's one-time commander Rickover is now giving Carter frequent briefings on Soviet military and strategic weakness which do not exist, steeling him for a nuclear confrontation with the USSR.

The alternative to such insanity is full and rapid development of nuclear power for world progress.

7. See American Nuclear Society, "Questions and Answers — Nuclear Power and the Environment," April 1976 for the best treatment of this question. See also the suggested reading list.

8. *New York Times Magazine*, pp. 39 and ff.

Suggested Readings

American Nuclear Society, "Questions and Answers — Nuclear Power and the Environment," April 1976.

Cohen, B.L. "The Hazards of Plutonium Dispersal." *Nuclear News* 18: 8, pp. 44-45 (June 1975).

Medical Research Council. "The Toxicity of Plutonium." Medical Research Council Committee on Protection Against Ionizing Radiations, Her Majesty's Stationery Office, London (1975).

Healy, J.W., Richmond, C.R., and E.C. Anderson. "A Review of the Natural Resources Defense Council Position Concerning Limits for

Insoluble Alpha Emitters," LA-5810-MS, U.S. Atomic Energy Commission (November 1974).

"Plutonium and Other Transuranium Elements: Sources, Environmental Distribution and Biomedical Effects," WASH-1359, U.S. Atomic Energy Commission (December 1974).

Regulation Operations Investigation Report 74-09, Directorate of Regulatory Operations, U.S. Atomic Energy Commission (Nov. 8 to Dec. 4, 1974).

Spinrad, B.I. "Panel on Nuclear Safeguards — What's Reasonable." Presented at a meeting of the American Nuclear Society, November 16-21, 1975.

Salisbury, D.F. "How Modern Science Prevents Nuclear Theft." *Christian Science Monitor* (July 14, 1975).

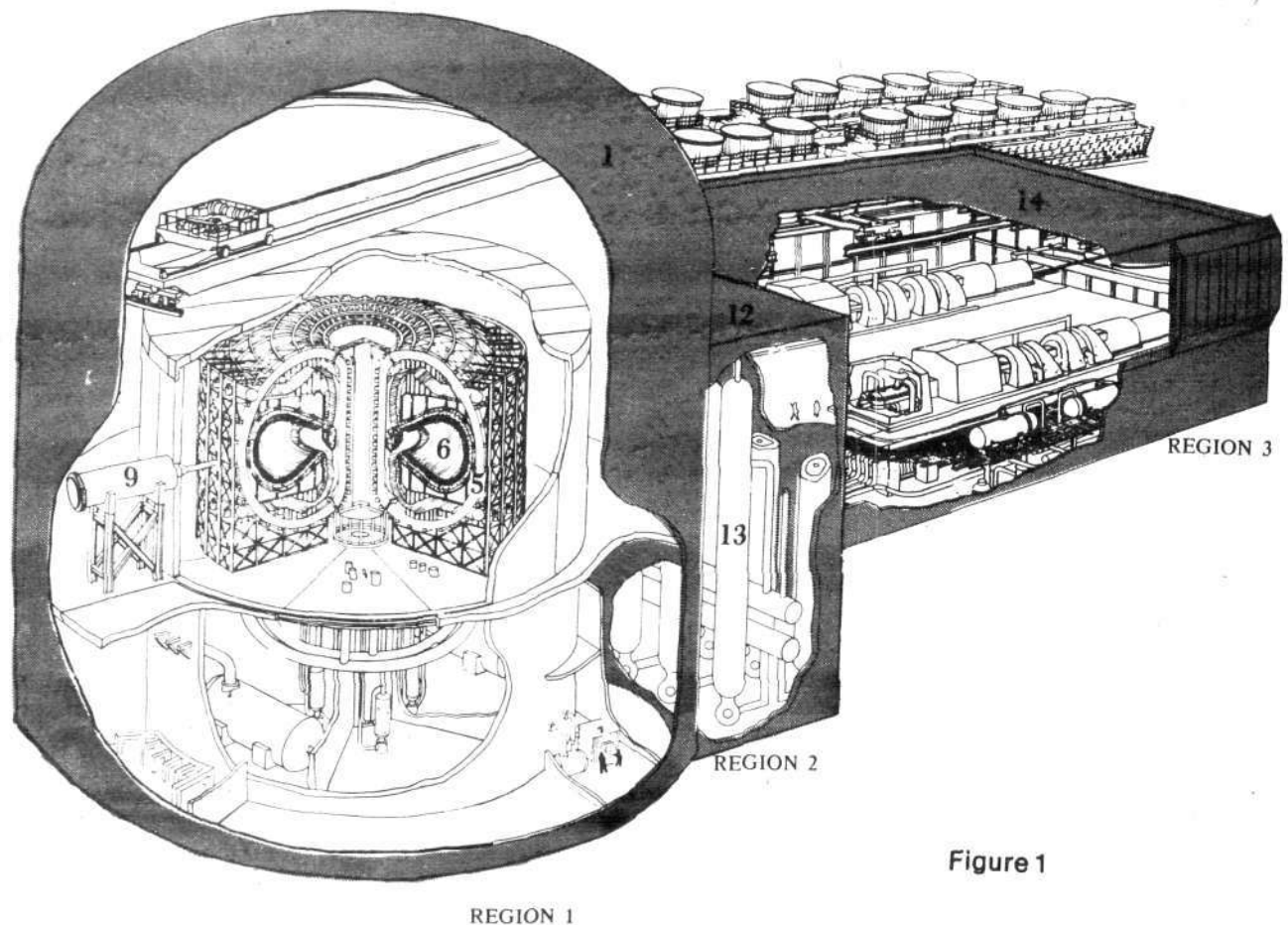

Figure 1

U.S. Aerospace — The Keystone to Fusion Development

Jon Gilbertson

Aerospace is the most technologically advanced industry in the United States, with crucial immediate potential to help bring the world into the fusion energy era. Yet it is being ground down between the military utopians' hell-for-leather war drive and the attempts by their inept traditionalist opponents to maintain "porkbarrels as usual." To counter a situation which by any sane criteria represents a severe setback for this country's national security, I present here a program for redeployment of U.S. aerospace capabilities necessary to maintain America's position as the world's leading industrial power in an expanding world economy.

The bind in which aerospace (in particular) finds itself was underscored by the recent Rudakov affair (see page 30). Leading Soviet scientist L.I. Rudakov on tour here this summer accompanied his dramatic unilateral

declassification of aspects of recent Soviet fusion research breakthroughs with an offer for U.S.-Soviet collaboration on future research. The Soviets have previously made several such offers for joint work, stressing the mutual advantages of combining the Soviet Union's pioneering scientific efforts with the United States' tremendous technological capabilities — epitomized by the aerospace sector. The U.S.'s de facto official response was to impound the university blackboard on which Rudakov's presentation had been made and to escalate press attacks and smear campaigns against traditionalist advocates of increased East-West cooperation.

Those who looked to the "Carter team" in hopes of a war-fueled boom for the gutted aerospace sector have instead been confronted with grim evidence of a go-

for-broke policy of deindustrialization. In the last few weeks aerospace industries in the Connecticut Valley announced that they were slashing their operations amid press predictions of the collapse of the entire industry; layoffs of thousands of workers have been reported by firms like Pratt and Whitney and Sikorsky Aircraft.

The latest crunch comes on top of a long-running process of collapse. From 1968 to 1974 employment in the aerospace industry — the greatest concentration of skilled manpower anywhere in the world — dropped by 35 per cent, with even greater reductions since. Aerospace and related sectors are now estimated to be operating at 60 per cent of total capacity or less.

What is being destroyed is an industry whose research and development budget still makes up a whopping 50 per cent of all U.S. industrial R and D. In fact, the 1976 Defense Department budget for the critical area of materials research and development in the aerospace industry alone is larger than the Energy Research and Development Administration's total fusion development budget!

This research and development capability, and the quality of technology and manpower that accompany it, pinpoint aerospace as the keystone of the development effort necessary to bring a fusion economy into being — solving the scientific problems that still stand in the way of constructing working fusion reactors and providing the level of productive capacity necessary to produce such reactors to power the world. Based on the Fusion Energy Foundation and the U.S. Labor Party's proposed fusion development budget estimates, reaching a \$25 billion-per-year level by the fifth year, a program for fusion development would catapult aerospace out of its present collapse into growth of 40 per cent within that five-year span, while employment in aerospace and the related electronics industry would increase by at least a half million workers, scientists, engineers, and technicians. During the same time other parts of the industry will be deployed to vital projects in transportation development, space exploration, communications, and certain consumer goods, creating additional hundreds of thousands of jobs.

Simultaneously basic research will receive a massive influx of funds and qualified scientists through the establishment of ten National Fundamental Research Centers and a large expansion of funding to universities for training and research. The ten centers will be constructed, equipped and staffed in areas of the country (see map) where institutions, industry, and individuals with significant competence and experience in the science and technology of fusion are already located. All scientists in each center's region will have access to its facilities.

The Tools at Hand

The aerospace and electronics industries, spread across the United States and concentrated in the nation's most important industrial centers, represent a strategically located pool of manpower and capacity for hugely expanded U.S. fusion effort.

The majority of workers in electronics manufacturing are located in California, on the West Coast; New York, New

Jersey, Pennsylvania, and Massachusetts on the East Coast, and Illinois and Indiana in the Midwest. Likewise aerospace has 41 per cent of its plants on the East Coast, 34 per cent on the West, with the remaining 25 per cent split between the Midwest and the central Southwest. The proposed crash fusion-power development program, and the concomitant upgrading and expansion of these industry centers, will therefore have an immediate effect — through tremendously increased employment, industrial activity, etc. — on cities such as Boston, Los Angeles, Seattle, Dallas-Fort Worth, Hartford, and New York.

The total sales for both industries, \$61.7 billion in 1974 (the last year for which comprehensive figures are available), amounted to roughly 6 per cent of all U.S. manufacturing sales. Of that, over 35 per cent are related to Defense Department contracts — roughly 50 per cent of all production for aerospace, 25 per cent for electronics. The remainder involves such diverse fields as consumer goods, communications equipment, industrial products, and space exploration.

The combined research and development capabilities of aerospace and electronics are huge, with investment in 1974 totaling over \$11.4 billion. Just as this investment amounts to 50 per cent of such activity in U.S. industry as a whole, the number of scientists and engineers employed in R and D in aerospace-electronics, over 165,000, is close to half of the total of 360,000 for all U.S. industry.

This margin is being destroyed by an unemployment rate in the research and development area that had already hit 30 per cent between the peak year of 1968 and 1974, in part reflecting the 10 per cent collapse in all U.S. R and D over the same period. The destructive pattern is similar for the two industries' overall employment. This concentration of the country's highest-skilled workers, most closely approximating the worker-scientists of the future, was bled of more than half a million workers in the period 1968-74, reduced from 2.5 to 2 million.

Because of their importance to the economic life of several regions of the United States, the redeployment of these industries to the development of fusion power will have dramatic repercussions. With manpower requirements increasing by as much as 40 per cent for aerospace and 15 per cent for electronics over the first five years of the program — approximately 400,000 jobs in the former and 150,000 in the latter — and a massive influx of capital spreading out to other area industries, each of these regions will experience the greatest economic-industrial boom in their history. Of course, in the context of worldwide International Development Bank-type credit and trade arrangements such patterns of rapid growth will be the norm for the entire spectrum of U.S. industry.*

The development of fusion power, while promising a virtually limitless supply of energy, is the greatest technological challenge that man has ever faced. Only the Manhattan Project, with its simultaneous broad-based scientific probing of all promising concepts, or the Apollo space program, with its massive funding of high technology, engineering development, and task orientation, even comes close to the kind of program needed to develop fusion.

The benchmark of fusion "breakeven" (i.e., the point at

* The original U.S. Labor Party proposal for an International Development Bank is available in pamphlet form from Campaigner Publications, Box 1972, GPO, New York, N.Y. 10001 for \$1.50 postpaid. In recent weeks there have been an increasing number of three-way trade arrangements

between Western Europe, the socialist sector, and Third World nations — particularly the oil-producing states — along the lines described in the IDB.

Location and Density of U.S. Aerospace Industry

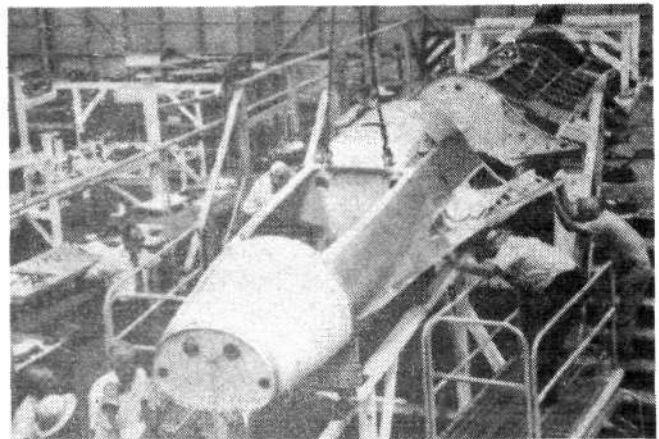

Figure 2

which energy out of the fusion reactions equals the energy input needed to produce the reactions) has not even been experimentally achieved yet, but the results of several recent tests show that this result can be expected within one to two years under present research arrangements from the next generation of scaled-up fusion machines — probably first in the Soviet Union, then in the United States (in spite of abysmally low-level funding on the U.S. side). But the step from these experimental reactors to full fusion power plants generating electricity and, further down the line, providing energy for techniques such as the fusion torch, is a giant one, involving the solution of both the most fundamental problems of physics theory and many formidable engineering problems. The U.S. aerospace sector is unique in the world for the level of technology and skill it offers toward finding these solutions.

To describe the aerospace industry's role in developing fusion, we sketch here the fundamentals of a fusion reactor, taking the Tokamak magnetic confinement device (as of now the design on which the most advanced research has been done) as the model. The first-generation Tokamak fusion plant, shown in Figure 1, can be generally described by reference to three regions.

The first is the fusion reactor itself, which is enclosed within the dome-like containment building. Central to the reactor is the toroidal (doughnut-shaped) vacuum chamber which contains the fusion plasma. This chamber is surrounded by a lithium blanket for the "breeding" of lithium fuel, a radiation shield, a helium or lithium cooling system for transferring the super-intense heat of the plasma and blanket to the steam generators, and large superconducting magnets and other magnet systems to hold the plasma in place. The plasma is brought up to ignition tem-



The combined research and development capabilities of aerospace and electronics are huge — \$11.4 billion in 1974 — and the number of scientists and engineers in aerospace-electronics is close to half the total for all of U.S. industry.

peratures by neutral beam heaters, while still other systems are required to bring the deuterium-tritium fuel mixture into the vacuum chamber and recover any unburned fuel.

The second region is the heat exchanger and steam generation building. Here heat is transferred from the fusion reactor and cooled to usable temperatures via piping containing helium or lithium coolant, and through heat exchanger-steam generator systems to a water-steam mixture.

The system generated in these heat exchangers drives the steam turbines in the third region, which also includes steam condensers and electrical generators, as well as the fusion reactor power supply and storage system.

The development of special materials will be required for several areas throughout the reactor, but the most challenging materials difficulty will be that of the vacuum

vessel that contains the fusion plasma. There a vacuum must be maintained under extreme conditions: not only does the vessel's wall serve as a transfer surface, from which some portion of the plant's total power must be drawn at an extremely high temperature, but it is subjected to high levels of radiation. The development of a material than can withstand these conditions for relatively long periods of time will require a major research and development program.

The containment and processing of the tritium fuel in the reactor blanket regions poses a similar need for entirely new types of materials, as do the related problems of fueling the plasma with deuterium and tritium and recovering the unburned fuel. Since tritium will be produced as part of the operation of the reactor, whether in the form of lithium metal or its compounds, a method of processing must be discovered which can rapidly extract the tritium from the lithium medium, convert it to a usable fuel form (e.g. pellets), and get it into the fuel chamber together with the deuterium, the other half of the reactor's fuel cycle. Tritium is a low-energy radioactive material, and although it is far, far less hazar-

dous than the products of fission reactors, it still must be properly contained and released into the atmosphere in only limited and carefully controlled amounts. This engineering problem is made all the more difficult by the fact that tritium, like any other isotope of hydrogen, is able to diffuse through all known construction materials at temperatures over 300 degrees Centigrade, the order of magnitude involved in a fusion reactor. Therefore, other new materials or coatings are required here.

Further developmental effort will be required for the construction of the very large "superconducting" magnets that confine and compress the plasma, and their associated electrical power supply, power storage, and electronic systems. While the superconductors require a very low temperature (cryogenic) environment, this environment is directly adjacent to the lithium blanket and heat transfer area of the machine, which is extremely hot, meaning that insulating materials that can act as a barrier between these two drastically different environments must also be high on the materials development agenda.

Probable Industry Involved

Heavy Industry
Nuclear Industry
Aerospace
Electronics
Utilities, architectural engineering
Mining, metals
Chemical
Power Plant supplier
Petroleum

Industries Required for Tokamak Fusion Power Plant Development and Construction

Power Plan Systems and Supplies								Similar Industry Existing for Fission Reactors	New Industry Required
REGION I									
x									
	x						x		
	x						x		
	x		x				x		
x		x	x					x	
x		x						x	
		x						x	
		x	x					x	
		x						x	
	x	x				x		x	
	x	x						x	
REGION II									
x									
	x						x		
	x						x		
REGION III									
x									
		x	x				x		
			x					x	
ALL REGIONS									
x			x						
							x		
							x		
			x				x		
	x	x						x	
		x						x	
		x						x	
	x	x							
							x		

Building the Future

To build the fusion power plants and fusion-run industries of the future will require an unprecedented development of existing industries as well as the creation of many new ones (see Table), an industrial and technological transformation historically comparable to the industrial revolution of the 1800s but several orders of magnitude greater in both production capacities and the range of scientific and technological innovations.

The aerospace-electronics sector has a crucial role to play in two critical aspects of this program for fusion development. First, its immense research capability must be turned to the research projects (other than the more specialized basic plasma physics research effort) in, for example, special materials, superconducting technology, and the switching and power storage techniques demanded by the high-pulse energy requirements of fusion reactors. Second, these industries can immediately take on the main task of building the large-scale test reactors needed to further our knowledge of fusion plasma processes.

As in the space program, fusion work requires the rapid construction of complex, one-of-a-kind machines and the equally rapid modification of such machines on the basis of test results and theoretical work. At present such devices are being literally built by hand at tiny plasma physics laboratories with virtually no equipment for high-technology parts production. Aerospace and electronics manufacturers, on the other hand, with their modern, flexible machine tools and other automated equipment, and their top engineering and technical manpower, are perfectly suited to efficient and rapid production of test models. Three such machines — a 100-meter theta pinch, a 40-meter scyllac, and an enlarged version of the Massachusetts Institute of Technology's Alcator — could be producing valuable results within a year if initiated now using aerospace capabilities.

As for materials research, the aerospace sector is already the leader in the field of developing materials with resistance to extreme environments, expertise which has obvious applicability. A tremendous amount could be accomplished if even a relatively small portion of the industry's materials research budget — which is larger than the United States' entire fusion development program! — were turned to the above-indicated problems posed by fusion reactors. Research already in progress in areas such as insulation technology, high-temperature seals, and composite struc-

tural materials will find immediate application in a mass-scale fusion effort. For example, the development of the space shuttle, with its immediate goals of manufacturing extremely high quality, completely homogeneous materials in the zero-gravity conditions of outer space, is sure to have direct or indirect applications to fusion reactor materials development. In any of these areas, the question is primarily that of simply focusing a portion of the scientific and technical expertise that already exists onto the immediate requirements of developing working fusion reactors.

As fusion progresses toward the implementation stage, the aerospace and electronics industries, together with other related sectors of production, will develop mass-production, automated manufacturing techniques for the large-scale production of components for operating reactors. The scale of this effort is indicated by the fact that between 1980 and 1985 perhaps 20 to 30 different types of prototype fusion reactor systems will have to be constructed on a crash basis.

The Role of Other Industries

Of course the aerospace sector will not be able to carry out such an assignment without the assistance of other industries. Many existing high-technology industries involved in the construction and manufacture of both fossil- and nuclear-fueled power plants and equipment will have to be expanded and to some degree modified to meet this demand. Since electrical and other power utility companies will have the responsibility of purchasing and building many of these plants, they will also have to play a key role, while many new industries will come into being to mass-produce much of the specialized fusion reactor equipment that currently must be hand-crafted in laboratories.

The construction of fusion reactor plants will readily incorporate the manufacturers of fossil-fueled boilers, fission reactors, heat exchangers, steam and turbine generators, and other related equipment. Some of these industries will also develop new technologies for manufacturing magnet and vacuum systems, nuclear waste disposal systems, and other operations which will only come into mass production with the advent of a fusion development program. Likewise the chemical extraction, and mining industries will be involved in the areas of reactor fueling and fuel supply, on-site fuel processing, and production of special alloys and other specialized construction materials.

INTERNATIONAL JOURNAL OF FUSION ENERGY

MANAGING EDITORS

Dr. Steven Bardwell
Dr. Morris Levitt

INITIATING EDITORIAL BOARD

Dr. Winston Bostick
*Professor of Physics
Stevens Institute
of Technology*

Dr. Robert Moon
*Professor-at-large
University of Chicago*

Dr. Lloyd Motz
*Professor of
Astronomy
Columbia University*

Dr. Daniel Wells
*Professor of Physics
University of
Miami, Florida*

The **International Journal of Fusion Energy** is sponsored by the Fusion Energy Foundation for the advancement of theoretical and experimental conceptions necessary for the realization of fusion power. The Journal aims to stimulate investigations of plasma dynamics from the standpoint of fundamental theoretical problems of physics, as well as to promote development of the revolutionary technologies and production techniques that are intrinsic to fusion processes.

Whatever the significant, hard-won progress and breakthroughs in fusion to date, it can still all mean nothing — unless there is a political commitment to carry it through to fruition and a climate supportive of wide-ranging research.

The **IJFE** will be one of the few journals designed to be read from cover to cover because it provides what fusion scientists and non-specialists need in addition to updates on more technical developments: an ongoing **synthesis** of fusion research. To get efficient fusion reactors there must be continuous mutual interaction of improvements of theory and of devices — not simply improvements in the theory of existing devices. And to justify support for a growing research effort before payoff, there must be an understanding in Congress and elsewhere of the process of converging on various solutions that repay the original investments many times over.

The **IJFE** will fulfill this vital function by publishing articles of three basic types

- * historical reports on important lines of development
- * studies on the convergence (or divergence) and possible resynthesis of various approaches and
- * totally new conceptions

The **IJFE** will be a focal point for stimulating the conceptual developments and pro-scientific climate without which fusion will not reach its goal.

Directly related to the **IJFE's** function are the more general activities of the Fusion Energy Foundation, which has been the most important institution — aside from the front-line researchers — for the survival and development of fusion research. Subscribing to the **IJFE** helps to finance and extend the influence of the FEF and this gives fusion scientists a social potency they are otherwise lacking individually.

IJFE SUBSCRIPTION FORM

Enclosed is my check for:

IJFE subscription (four issues) — \$35

FEF annual membership plus IJFE subscription — \$50

There are four issues per volume, and subscriptions are on a volume basis only. All subscriptions must be prepaid in U.S. dollars drawn on a U.S. bank. Add \$5.00 for postage per subscription outside U.S. and Canada. All back volumes are available.

Name _____

Title _____

Street _____

City _____

State _____

Please make all checks payable to **Fusion Energy Foundation**. Send check and completed form to IJFE, Subscription Dept., GPO Box 1943, New York, N.Y.

FUSION RESEARCH NEWS

The Rudakov Affair

U.S. Fusion Is in Second Place

One of the most important scandals of military-scientific incompetence to hit the United States in the post-war period was triggered by a stunning set of disclosures on Soviet fusion and weapons-related capabilities made by Soviet physicist Leonid I. Rudakov during a July visit here.

Rudakov's disclosures demonstrated that Soviet laser fusion research is embarrassingly ahead of U.S. efforts, and during the discussion Rudakov unilaterally declassified Soviet experimental results. This declassification now makes it politically prohibitive for the U.S. government to continue to use "top secret" labels to downgrade American research into inertial confinement, the most fruitful line of fusion research.

The Energy Research and Development Administration compounded the scandal by ineptly trying to cover it up. Immediately after Rudakov's visit, ERDA ordered U.S. fusion scientists to claim that Rudakov did not say what he actually had said.

Two and one-half months after the Rudakov visit, the only public disclosure of the scandal to make it into print were July 20 and Sept. 22 FEF reports exclusive to *New Solidarity* (See section below on Soviet Developments for the content of the July FEF report on Rudakov) and a report in the September issue of the prestigious joint Soviet-American journal *Laser Focus*.

According to that journal, the revelations made by Dr. Rudakov on Soviet electron beam fusion research represent "the first major innovation in design to be reported since the wide disclosures in 1972" by U.S. fusion scientists.

The Facts

The larger story, by now well known to many members of the fusion community, is, however, far more lurid and



Leonid I. Rudakov

directly implicates top ERDA and other governmental officials in the gross mismanagement of U.S. energy research as well as strategic weapons systems development — their supposed specialty.

Here are the facts: In the first two weeks of July, Dr. Rudakov, on a U.S. tour, attended the Gordon Plasma Physics Conference and then visited three major fusion laboratories: Livermore, Sandia, and the Naval Research Lab. It was at Livermore that Rudakov dropped his bombshell. In response to a snide comment attacking Rudakov's work by Dr. John Nuckolls, Rudakov proceeded to fill a blackboard with a detailed analysis of how the Soviets have mastered the conversion of electron-beam energy into forms suitable for efficient compression of target pellets of fusionable material. (It is reported

that intelligence experts later pored over the now-classified blackboard in a manner reminiscent of the deciphering of the Rosetta Stone.)

Rudakov's presentation was so shocking in its implications that the ERDA Laser Fusion Division immediately put out telegrams to all major laboratories instructing them to "play dumb" and admit that Rudakov had made some disclosures, but to cover up the significant material. However, as word spread and pressure built up in the U.S. fusion community for full disclosure and taking up of Rudakov's offer of full research collaboration, ERDA was forced to authorize the *Laser Focus* article.

Rudakov's timely lecture had revealed that the Soviet Union is far ahead in both controlled fusion and fusion weapons development, and that they had gotten there by putting at the center of their research program precisely the nonlinear interactions which ERDA claimed were merely incidental features to be smoothed over in the strictly classified weapons program. Nuckolls had announced at the Amsterdam Quantum Electronics Conference June 16 that the U.S. laser fusion effort would have to be effectively scuttled since "anomalous" effects in laser-plasma interactions precluded the use of all but those approaches classified top secret under hydrogen bomb weapons designs.

Rudakov's Disclosure

At the heart of Rudakov's work lies the following principles: in order to achieve the maximum net release of fusion energy, negentropic, or at least isentropic (no increase in entropy) processes are required. In both H-bombs and laser, ion, and electron beam pellet fusion, maximum release of fusion energy is obtained by achieving the maximum compression of fusion fuel prior to its being heated to thermonuclear ignition temperatures. This, broadly speaking, is isentropic compression. The problem is that the direct application of most forms of energy for compressing fusion fuel tends to preheat all of the fuel, preventing maximum, isentropic compression from being obtained.

For example, an ideal hydrogen bomb would use the vast energy of the

fission bomb trigger for preignition compression of the fusion fuel. But the neutrons, hard x-rays (high energies of over 1,000 electron volts) and other forms in which the fission energy is produced penetrate and preheat the fusion fuel.

One of the specific points that Dr. Rudakov disclosed was the fact that if the laser, electron beam, or hard x-rays could be transformed into soft x-rays (low energies of 100 or 200 electron volts for example), then in this form the energy would be ideal for efficient isentropic compression of fusion fuel.

For example, consider an electron beam pellet system. Instead of being used to ablate an outside layer of material off of a pellet to drive an implosion, the fast electrons are "anomalously" slowed down by a high-Z (Z being the atomic number) metal outer shell. In this way the energy is transformed into soft x-rays. An inner shell of fusion fuel is therefore irradiated with soft x-rays producing an ablating, plasma blow-off which compresses, effectively, only this shell.

The soft x-rays are ideal for efficiently penetrating the ablating

plasma blow-off to reach the surface of the nonionized, remaining fusion fuel, because soft x-rays are the perfect energy range for photoionization, they ionize a very thin layer of fusion fuel, driving the compression further while not preheating the remaining fusion fuel. The integrity of the outer metal shell is maintained so that it acts to reflect the compression shock waves back on the fusion fuel to multiply their effect.

Common Knowledge

The Rudakov scandal — and the fact that the U.S. fusion development program was in second place — became common knowledge in the scientific community when *Science* magazine, the official weekly journal of the largest U.S. scientific organization, the American Association for the Advancement of Science, featured an Oct. 8 article entitled "Thermonuclear Fusion: U.S. Puts Wraps on Latest Soviet Work."

Science recounted visiting Soviet physicist L.I. Rudakov's disclosure of

Soviet research breakthrough in producing fusion through electron-beam bombardment of small fuel pellets. The article also noted that Rudakov's declassification caused "a number of mouths to drop open" at the three government labs where he spoke.

In addition to confirming the scandal as FEF had outlined it, the *Science* article confirmed as well that ERDA officials had called the labs Rudakov had visited, instructing them to keep his public talks "quiet." As William D. Metz, author of the *Science* article, notes, "It seemed as if the system designed to keep American secrets from getting out was being applied to keep Soviet secrets from being broadcast."

Under the bizarre security system inherited from the wartime Manhattan Project, U.S. scientists refused to comment to *Science* on what the magazine termed Rudakov's "apparently brilliant idea" for fusion pellet design, and according to Metz, "no American researcher says for attribution whether Rudakov's ideas are classified because the classification guidelines themselves are classified."

Soviets on the Verge of a Strategic Weapons Breakthrough

The following news analysis, written by Uwe Parpart, Director of Research and Development for the U.S. Labor Party, appeared in New Solidarity Oct. 15, 1976.

In a prominent place in his Sept. 28, 1976 address to the United Nations General Assembly Soviet Foreign Minister Andrei A. Gromyko warns that "It is not only the already stockpiled means of mass destruction which pose a threat. Potentially, **weapons based on qualitatively new operating principles** in terms of methods of use, targets or effect could become no less formidable. Today they may exist only as blueprints, mock-ups or ideas, but experience shows that their appearance may not be too far away."

These are no idle threats and, in particular, the emphasis on qualitatively new operating principles is most relevant.

Disclosures by the Soviet electron beam fusion researcher Dr. L.I. Rudakov, first reported earlier this month and now known in greater detail, leave no reasonable doubt that Soviet scientists have mastered scientific

technological capabilities which at a minimum would permit them to improve the efficiency of their thermonuclear weapons in the short run to the extent of increasing their payload capability with existing delivery systems by a factor of between 2 and 10. On the intermediate level (one quite possibly already achieved) the Rudakov results, exploiting nonlinear plasma effects, imply the construction of gigaton (one gigaton equals 1000 megatons equals one billion tons) TNT equivalent H-bombs.

Clearly, both of these potential military applications of the Rudakov disclosures — a tenfold or higher increase of Soviet throw-weight mounted on existing delivery systems, and the availability of gigaton bombs — have major implications effecting qualitative changes in existing nuclear war-fighting capabilities. In the longer term, the work of Soviet researchers on high-energy, dense plasmas, as indicated by the general nature of Rudakov's researches, points toward the development of the scientific-technological means for the efficient pro-

duction and confinement of anti-matter. While it is unlikely, given the great difficulties in handling anti-matter — which is totally annihilated when it comes into contact with ordinary matter, producing electromagnetic radiation — that anti-matter would be used as bomb material itself, it does provide an ideal trigger, even in minute quantities, for setting off H-bombs of any desired size.

The Strategic Context

As developed in the LaRouche presidential campaign statement of Oct. 10, "The Men Behind Carter's Bid for Thermonuclear War," the summer of 1977 defines a "point of no return" for thermomuclear confrontation between the U.S. and the USSR, if in the case of the election of James Earl Carter the U.S. were to attempt to maintain existing financial structures through deindustrialization measures and the worldwide imposition of Schachtian forms of looting of economies, natural resources and populations. At least in part the mid-1977 deadline is established by the

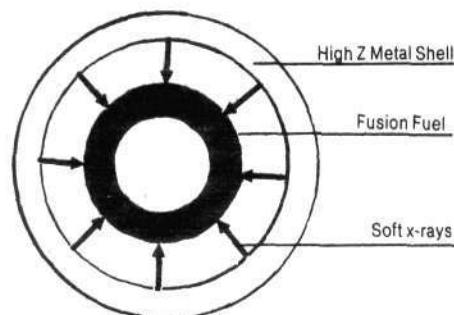
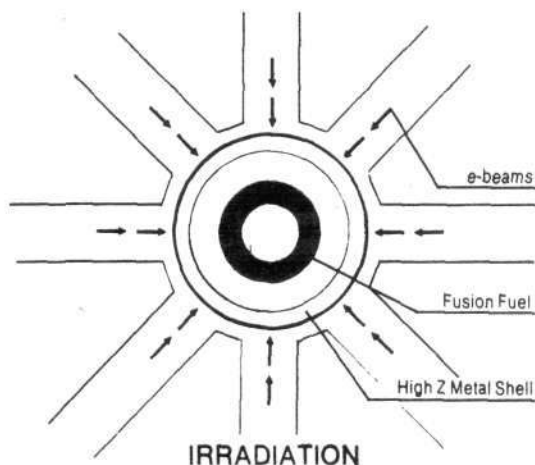

This diagram shows step-by-step the results of Soviet scientist Rudakov's disclosures at the Livermore Laboratory

fact, admitted by most specialists (cf. Paul Nitze in *Foreign Affairs*, January 1976), that from that point on the Warsaw Pact will begin to enjoy a decisive margin of strategic war-fighting superiority over NATO. Predictions of such post-mid-1977 marginal Warsaw Pact strategic superiority are based on the evaluation of significant divergent tendencies in U.S. and Soviet strategic military deployments and weapons development policies.

As acknowledged in both the Defense Department's and the U.S. Military Research and Development Division's budget reports, the U.S. is going primarily for development "in width," i.e., mere *quantitative* expansion in production and deployment of existing weapons systems. In coherence with the utterly ill-conceived "fine-tuning" of war-fighting envisaged by "flexible response" strategies, exploitation of qualitatively new technologies is in evidence only in the development of "precision-guided munitions" etc. reminiscent of the Nazi "Wunderwaffen" craze. The Soviet Union, on the other hand, has consistently pushed for maximum feasible expansion of its basic scientific research capabilities and the most rapid "brute force" development of weapons systems based on fundamental scientific breakthroughs.

The Rudakov disclosures and their military applications mark the culmination point to date of these efforts.

Western Schizophrenia

Not surprisingly, the growing awareness of the magnitude of the soon-to-be-realized qualitative technological ad-

vantage of the Soviet side has induced a state of acute schizophrenia among Western military analysts. Thus on Oct. 10 the *New York Times's* Drew Middleton confidently writes from West Germany that, through the use of new tactics tailored to the employment of precision anti-tank weapons, U.S. and West German forces will be able to repel "Soviet invaders."

The very next day in a dispatch from London, reality sufficiently impresses itself upon him and he now reports acute fears by himself and "intelligence analysts in North Atlantic alliance governments" that the Soviet Union may be well on its way toward developing a strategic war-winning capability. Simultaneously, there are reports (*Atlantic News*, Brussels, Oct. 8) that "a team of American specialists at the scientific laboratory in Los Alamos" has reached the conclusion that the "the official American 'flexible response' strategy should be abandoned as dangerous and out of date and replaced by a new 'forward strategy' based on the almost immediate use of tactical nuclear weapons."

Finally, there are reports that severe policy disagreements have broken out in the highest command structure of West Germany's Bundeswehr. All these signs of strategic uncertainty are precisely the kind of signs that would generally be associated with an impending major shift in the strategic balance. Ironically, such a shift can give little comfort even to the Soviet Union; it may very well already have moved up the time-table for nuclear

confrontation of the madmen behind Carter's bid for the presidency.

H-Bombs

The first known concept of an H-bomb was put forward by Enrico Fermi in 1941. He proposed to wrap the projected fission bomb with deuterium-tritium (D-T) fusion fuel in the expectation that the fission explosion would heat the fuel to ignition temperatures and thus lead to greater overall energy output. The problem with this idea is the relatively slow rise time of the fission reaction. It does not, in general, give sufficient heating fast enough to produce a sufficiently fast thermonuclear burn rate. Thus, most of the fusion fuel will explode before significant amounts of fusion energy have been produced.

The solution lies with isentropic compression, i.e., the compression of the fusion fuel to maximum density before the occurrence of any significant heating. Since the rate of the fusion reaction increases with increasing density, once ignition takes place a sufficient amount of fusion will occur before the fuel blows apart. This leaves the question of how the isentropic compression of the fusion fuel mass is to be achieved. Leaving all technical details aside, the compression process can be conceptualized as follows: Surround the fusion fuel, which in turn surrounds the fission core, with a chemical explosive. The shock waves generated by the explosion of the chemical will then compress the fusion fuel; the fusion fuel compresses the fission core, which finally sets off the fusion reaction. The

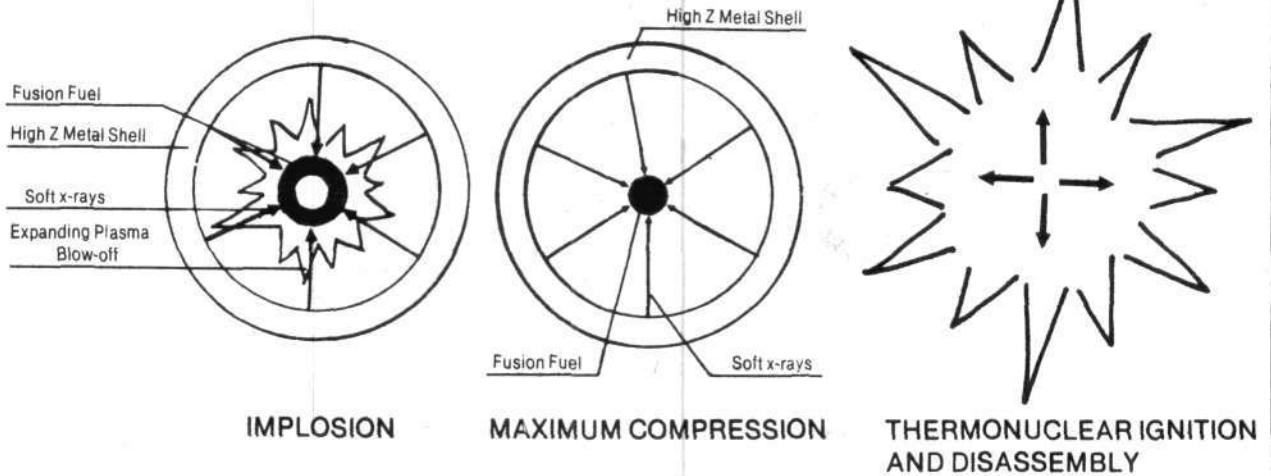

on how an electron beam pellet system can achieve maximum net release of fusion energy.

principal limitation of this approach is defined by the maximum force of the chemical explosion.

Ideally, one would want to use a fission explosion instead for compression purposes and greatest burn efficiencies. This is barred by the fact that a fission reaction produces an initial wave of hard x-ray radiation, which would preheat the fusion fuel and prevent significant compression.

It is at this point that the results of Rudakov's electron-beam fusion experiments can be brought into play. Rudakov has demonstrated that an electron-beam directed against a metal foil, which shields a pellet of fusible material, produces a highly nonlinear plasma configuration beneath the shield. Through interaction with that

plasma, hard x-rays are converted into soft x-rays, which in turn are capable of producing isentropic compression of the pellet of fusion fuel.

In general terms at least, the application of this process to bomb construction is straightforward (see illustration) and minimally should lead to significantly improved burn efficiencies which in present H-bombs lie, at best, at 10 per cent of the fusible material. Equally important, bomb sizes, which at present are limited by compression forces which chemical explosives can achieve, will be capable of major increases.

Of course, the possible use of a fission reaction for isentropic compression is not in itself a big secret; the question is how to do it, and the Rudakov results

demonstrate that to a large extent the involved, most advanced theoretical questions of nonlinear electromagnetic energy-plasma and matter interactions have at least empirically been mastered by the Soviet plasma physics research program.

Anti-Matter

It is the final irony of these developments that it was probably J. Robert Oppenheimer who, in his day, had the most advanced and acute perception both of the substance and the general significance of nonlinear radiation-plasma-particle interactions. He was hounded to death by the miserable Edward Teller, who in more than one way is directly responsible for the wretched state of the U.S. fusion program. One might call that treason.

H-BOMB

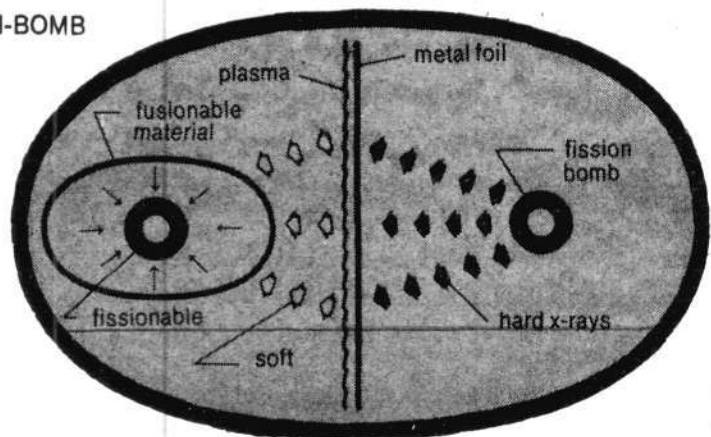

The Rudakov results, exploiting the nonlinear effects of plasma, imply a tenfold or more increase of Soviet throw-weight in nuclear war-fighting capabilities.

Soviets Propose to Close Fusion Gap, Offer Cooperation to U.S.

The following article was first issued by the FEF July 20, shortly after Rudakov's visit to the U.S.

During his whirlwind tour of the U.S. research labs in July, leading Soviet fusion researcher Dr. Leonid Rudakov proposed to close the "fusion gap" and combine U.S. technology with Soviet science by having key components for a prototype fusion reactor built in the United States.

Rudakov, in talks with groups of U.S. scientists, had detailed how his research team at the Kurchatov Institute in Moscow achieved the release of controlled thermonuclear fusion energy via electron beam-induced fusion for the first time anywhere in the world. The Soviets plan to construct a prototype fusion reactor based on this approach by 1980.

The Soviet daily *Pravda* had reported in March 1976 that Kurchatov researchers had "opened the road for development of an all fusion energy system" with their successful experiments on electron beam pellet fusion systems. This approach to the release of controlled thermonuclear fusion energy is similar to that of laser beam pellet fusion: an intense beam of high-energy electrons is used to compress and heat a small pellet of fusion fuel. Just as in the case of the internal combustion engine, the resulting microexplosion would provide energy for generating electricity or other industrial applications.

Electron beams have several advantages over laser beams since high-energy, efficient systems can be constructed with existing technology. But in the past the electron beam has had a disadvantage in that the high-energy electrons (electrons of several million volts) tended to penetrate the outer shell of the pellet, preheating the fusion fuel and therefore making it thermodynamically impossible to obtain the necessary high compressions of the fusion fuel.

Work by Soviet scientists, such as that of V.N. Tsytovich on high energy plasma turbulence, (see FEF Newsletter June 1976) may provide the means to achieve "anomalous" absorption of high-energy electrons in a properly prepared plasma — and the

details given by Dr. Rudakov tend to confirm that this is how he succeeded.

Rudakov identified the critical question which must be answered in any theoretical understanding of how the electrons interact with the pellet: what kind of behavior exists in the plasma which causes it to react with the formation of extremely high, self-generated magnetic fields, so that it can then absorb many times more energy than would otherwise be predicted. Rudakov implicitly demanded problems in the nonlinear, nonequilibrium behavior of plasmas be placed at the forefront of plasma physics research. In effect, Rudakov, like Galileo, is saying: "Here is the telescope — look!"

The Rudakov Experiments

The Soviet electron beam-induced fusion experiments were carried out on a relatively small machine, the Triton. Only 600 joules of absorbed energy from the electron beam produced the thousandfold compression and heating to over 11 million degrees centigrade of the fusion fuel. Several million fusion neutrons were observed in the all-deuterium gas, both with energy and time of flight (that is, velocity) measurements.

Only a section of a pellet was used in the experiments; a cone of 60 degrees solid angle was bored out of a flat slab of lead. Deuterium gas was injected into the cone and a gold foil of 5 to 10 microns thick was pasted over the top

of the cone. Dr. Rudakov did not completely detail how he was able to get the electrons absorbed into the thin gold foil. U.S. scientists have speculated that either a prepulse of laser light, or low-energy electrons may have been utilized to transform the gold foil into a hot plasma which could then absorb the high energy electrons. Further details will be made available in a forthcoming article by Dr. Rudakov.

Experiments on the much larger Soviet electron beam, Angara I, and calculations at Sandia Lab based on Soviet data, confirm the Rudakov success. The next experiment will utilize a cone of 120 degrees solid angle.

Fusion by 1980

Rudakov reported that the construction of an electron beam pellet fusion power reactor had already been put into the next Soviet five-year plan and will be completed by 1980. The design consists of 48 Angara modules which surround a spherical chamber 6 meters in diameter. The 48 electron beams are directed onto a pellet 2 centimeters in diameter through the use of a cusp-shaped magnetic field. The total energy of the electron beam would be on the order of 5 million joules per pulse, while each pellet microexplosion will release 100 million joules. Following this scientific demonstration of feasibility, the technological steps to actual power reactors would be no more difficult than that of a space program mission. Dr. Velikhov, director of the Kurchatov fusion program has already outlined the design of such an electron beam fusion power reactor which would utilize direct magnetohydrodynamic generation of electricity.

Because the system is based on the existing Angara I module, the 48 electron beam guns can be constructed on an industrial production line bases.

Soviets Plan Fusion Reactor by 1980

Edward Kintner, head of the fusion program of the Energy Research and Development Administration announced to a startled audience of fusion scientists meeting July 28 at Princeton University that the Soviet Union has taken another bold step forward in its brute force program to develop fusion power by the 1980s.

The Soviets, Kintner reported, informed a visiting ERDA-sponsored delegation in June that they have scrapped their earlier plans to follow up the now-operating T-10 Tokamak (a

toroidal, or doughnut-shaped machine which magnetically confines a similarly shaped plasma) with another experimental device, the T-20. Instead the Soviets will proceed directly to the construction of the T-10M Tokamak which, for the first time in a scientific experiment, will produce plasma conditions equivalent to those in a full-scale power-producing fusion reactor by 1980. Successful operation of the T-10M would set the stage for the onset of fusion reactors providing the energy for global economic and technological

development well within the 1980s.

Kintner issued his report on Soviet fusion efforts to scientists representing all major U.S. fusion research installations, at the annual ERDA Fusion Power Coordinating Committee review of research progress and planning. Princeton is the site of the Princeton Plasma Physics Laboratory, housing the U.S. equivalent of the Soviet T-10, the PLT.

The Scientific Justification

The scientific justification for moving as rapidly as possible to see if the Tokamak can serve as the first generation fusion reactor was summarized at Princeton by John Clarke, director of fusion research at Oak Ridge National Laboratory. Clarke reported that there is strong, if not yet conclusive, evidence that the two most serious limitations of Tokamak devices as reactors — low plasma energy density compared to magnetic field energy density (low "beta") and rapid deterioration of the "first wall" of the plasma chamber which is directly irradiated with high energy (14 MeV) fusion produced neutrons — could be overcome.

According to Clarke, there are now good reasons on theoretical grounds and by extrapolation of results on West German belt pinch machines to believe that with proper control of the magnetic field geometry and intensity, and plasma shaping, particularly at the plasma boundary (where a high Q, roughly the number of transits around the torus required to close a helical magnetic field line, is required), beta values many times greater than the presently expected several per cent can be achieved. Experimental and computational work at Oak Ridge has shown that available stainless steel-based first wall materials could bear a load of 20 Megawatt-years per square meter, permitting operation for several years rather than months. Finally, compilation of all existing Tokamak data and careful measurements at Oak Ridge appear to verify that the density-confinement time product scales with magnetic field strength and Tokamak geometry in a universal, and therefore predictable, way.

Putting all the Oak Ridge findings together in a preliminary design, Clarke conjectured that an economically viable reactor could be constructed within flexible design criteria to produce one Gigawatt from a plasma with 12 per cent beta on the order of a meter in cross section. The Oak Ridge group will cite these results in a forthcoming letter to *Science*.

rebutting the magazine's recent lies about the impossible problems of fusion technology.

The Soviet T-10M is designed to reach reactor conditions by simply using the most straightforward prescriptions to be had from previous results: to increase the crucial product of density times confinement time, increase the cross section of the plasma and of the doughnut "hole" (the former step increases the time for particles to drift out of the plasma, the latter helps confinement by making the field curvature small), and maximize the ratio, A, of cross-sectional radius, r, to average torus radius, R. It is also necessary to use the largest possible toroidal magnetic field, B, consistent with gross plasma hot enough to ignite fusion dump in as much energy as possible in the form of beams of high velocity neutral atoms of the fusion fuel, deuterium. The T-10M will therefore have an overall size of several meters, a toroidal magnetic field of 35 kiloGauss — using superconducting titanium coils for the first time in any major experiment — and be heated by a 10 Megawatt neutral beam source.

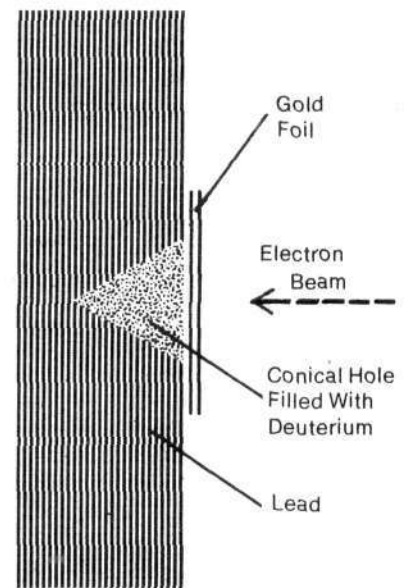

The Rudakov experiments: Only 600 joules of absorbed energy from the electron beam produced a thousandfold compression and a heating of the fusion fuel to over 11 million degrees centigrade.

Soviets Emphasize Broad Based Approach to Fusion

The Soviet magazine Sovetskaya Rossiya published a general review of the Soviet fusion power development program in August in the form of an interview with one of the leaders of the program. Excerpts from this interview with Dr. Boris Kadomtsev appear below:

"There was even a time when not a few atomic specialists were proposing

to shut down the CTR research program. But the pessimism of the 1960s is not forgotten, due largely, as is known, to the collective of scientists from the I.V. Kurchatov Institute of Atomic Energy, who...began the work on "Tokamaks," began Kadomtsev.

When asked if the successes of the Soviet experiments with Tokamak machines mean that CRT programs will be developed only along the Tokamak line, Kadomtsev answered: "Not at all..."

"A collective of scientists under the leadership of Doctor of Mathematical Physics L.I. Rudakov has just obtained very encouraging results on an e-beam installation at the Institute of Atomic Energy."

Kadomtsev describes the Rudakov experiment obtaining over a million neutrons through heating deuterium fuel in a lead cone to 10 million degrees.

"Scientists are now developing a special electron accelerator...to hit the target with many electron beams at once, compress and heat it to the necessary parameters, as is done with the laser. Unlike the laser program, the fast electrons make it possible to use both significantly larger explosion chambers, and high-power volleys. The energy released in this process will be the equivalent of the energy of the

Kosygin Urges Int'l Cooperation on Fusion

The Soviet daily *Pravda* gave front-page coverage Sept. 23 to Soviet Prime Minister Kosygin's message to the Twentieth Session of the General Conference of the International Atomic Energy Agency (IAEA) calling for increased international cooperation in the development of peaceful uses of atomic energy — and in particular "the mastery of thermonuclear fusion power."

The day before Kosygin's official statement to this United Nations-associated agency was printed, an article by leading Soviet laser fusion researcher Dr. O. Krokhin, in the daily *Izvestia*, reported that the USSR plans to build prototype laser fusion reactors by at least the mid-1980s.

explosion of over a ton of TNT.

"The facts indicate that a stable reaction is not far off. But how can this reaction be put on an industrial basis...In a word, what will the first 'solar' electric power station on the planet look like?"

"First of all, work on creating an industrial reactor must be distinguished from the so-called demonstration reactor. A draft plan for the latter, on the basis of the Tokamaks, has already been drawn up...to test the behavior of the plasma, when the output of useful energy is significantly increased.

"Aside from scientific problems, we still have a large number of unsolved purely engineering and construction problems. But none of the above-mentioned lines of scientific research should be left out of account. On the contrary, it is necessary to develop them as broadly as possible, since in the final analysis it is still unknown which will finally be the most acceptable for mankind. The problem of the century has yet to be solved."

Soviets Advance Fusion As Alternative to War

The Soviet chief of fusion research for the State Committee on Atomic Energy, E.P. Velikhov, continued the Soviet scientific offensive for international cooperation to develop fusion reactors by the 1980s as an alternative to nuclear war, in a November visit to the U.S.

Velikhov, who is also the assistant director of the Kurchatov Institute in Moscow, was the featured speaker in the November meeting in Washington, D.C. of the American and European Nuclear Societies and the Atomic Industrial Forum. During his initial presentation on the "The World Fusion Situation," Velikhov summarized the ground-breaking Soviet electron beam results that stunned the U.S. fusion establishment in July and reiterated the Soviet call for greater cooperation in e-beam and other lines of fusion development.

Simultaneous with Velikhov's initiative, Italian Science Minister Pedini, acting in the context of Soviet-Italian exchanges, called for full European cooperation in fusion development.

In The U.S.

Teller Endorses Soviet Drive For Fusion Power by 1980

Edward Teller, the man Nelson Rockefeller called "my scientist," admitted at a Nov. 18 press conference that working fusion reactors are possible within a decade, thus reversing his long-held position that fusion power must be put off until well into the next century. Teller's retreat under fire came in direct response to a detailed report by Soviet Academician E.P. Velikhov, director of the Soviet fusion research program, to the American and European Nuclear Societies' joint meeting in Washington, D.C.

Velikhov's representation demonstrated beyond doubt that the Soviet Union was aiming for fusion by the mid-1980s, whether or not the U.S. went along, and was fully capable of achieving this goal. At the joint press conference with Velikhov, Teller bowed to the inevitable and commented, "I join with Dr. Velikhov's prediction, that based on his excellent and complete overview it is shown, in fact demonstrated, that

within ten years fusion reactors will be working: reactors which produce more electricity than they consume."

The surrender by Teller, the leading scientific spokesman for Rockefeller's energy policies, of the key argument used by Rockefeller to justify those policies — "fusion is not practicable until the year 2000" — constitutes a singular victory for the converging global attack on the Rockefeller-energy empire. Faced with the public demonstration of qualitative Soviet superiority in the fusion field, which has been increasingly evident since mid-summer, the developing split of Western European governments from the U.S. on energy policy, and fusion in particular, and the growing hegemony of the ideas of the Fusion Energy Foundation in the U.S. scientific community, Teller had little choice but to abandon a position which has now become untenable. Teller and his right-wing lunatic allies in the environs of the Hoover Institute realize that to continue their "fusion can't work" line today is to merely make themselves laughing stocks.

The FEF Role

The breakthrough in the credibility of the Fusion Energy Foundation's authority among physicists in the U.S., a major factor in Teller's retreat, was dramatically demonstrated across the country at the American Physical Society plasma physics section meeting in San Francisco. An FEF team led by Dr. Steven Bardwell and backed up by U.S. Labor Party organizers sold to the 1,000 scientists attending no less than \$125 worth of literature, including the *Campaigner* issue featuring the first published translation of Georg Cantor's Foundations of a General Theory of Manifolds, the latest FEF newsletter, and the recent series of *New Solidarity* articles on the strategic implications of Soviet plasma physics breakthroughs. The scientists were not only excitedly discussing the FEF's crucial epistemological contributions to the study of nonlinear and self-organizing plasma phenomena, but the political and economic conceptions



Edward Teller.

of the Labor Party as well. Some were beginning to see that the same method lay behind Labor Party and FEF hegemony in both physics and politics.

At the American Physical Society meeting, Velikhov drummed home the enormous advances of the Soviet program and the necessity for international cooperation if fusion is to be achieved in the shortest possible time. He outlined Soviet progress in the construction of a working reactor based on the Rudakov discoveries in electron beam compression, a reactor the Soviets expect to finish by 1980. He also detailed Soviet research into the Stellarator magnetic confinement device, and the imploding magnetic field, LINUS machine, all of which showed major progress.

Velikhov's calls for expanded international cooperation on fusion were backed up in presentations by Dr. Andre Giraud of the French Atomic Energy Commission, who outlined the necessity for technology intensive development of the Third World and stated that Europe would proceed with nuclear development regardless of U.S. attitudes. The same policy commitment was repeated by Dr. R. Imai of Japan and G. Greenhalph of the European nuclear industry association.

Faced with this evidence of global motion to break the Rockefeller energy stranglehold, Teller backed down across the board. In addition to his admission that fusion could be developed by the mid-1980s, Teller dropped as well his equally long-standing opposition to free and open international fusion collaboration. In answer to a question, Teller said, "I am for cooperation in all aspects of this research. It should not be hampered in any way. There has been some limitation of cooperation, especially in inertial confinement research (lasers). This I do not endorse, I am for full declassification."

In reply to the strong thrust of world development, Teller stated that "failure to develop nuclear power will give rise to the causes of war — misery and starvation."

"Failure to develop nuclear power will give rise to the causes of war — misery and starvation." -Edward Teller

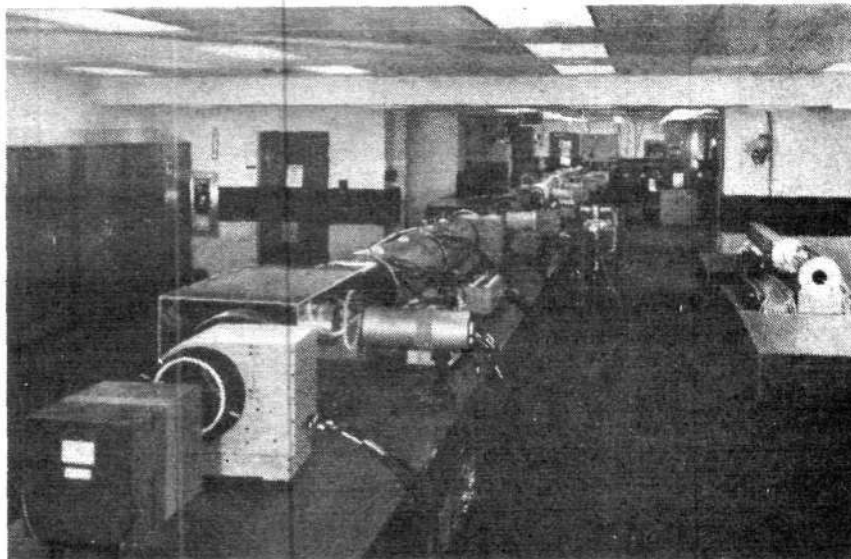

Two views of the laser hardware at Lawrence Livermore Laboratory. On the left, the target chamber; on the right, a chain of laser amplifiers.

New Fusion Breakthroughs at Lawrence Livermore

Fusion scientists from two groups at the Lawrence Livermore Laboratory (LLL) in California unofficially announced breakthroughs in both laser-induced and magnetic confinement fusion experiments the last week in October.

At the October European Conference on Laser Matter Interaction, the LLL group working on laser-induced fusion reported that their double beam laser system, the "Argus," had produced a plasma out of fusion fuel which released 2 billion neutrons per bombardment by the laser. These neutrons are almost conclusive evidence of fusion reactions taking place in the highly heated and compressed hydrogen plasma. The 2 billion fusion reactions are about 100 times more than the most successful previous laser-induced fusion reaction.

Even more important, the LLL experimenters were able to compute both the average energy of the neutrons and measure the collapse of the fusion fuel pellet, providing a detailed picture of a laser-matter interaction that takes place in only one 100-millionth of a second. Most significantly, their measurements were found to agree in detail with the theoretical predictions of a computer model, called LASNEX, which was constructed prior to the actual experiment.

Triple Mirror Machine

In the field of magnetic con-

finement, scientists from the group working on the mirror machine, the 2xIIB, this week proposed a new modification of the mirror machine which will be able to overcome the present inability of the mirror machine to support a high energy throughput. The proposed machine, which has also been contemplated by Soviet scientists is called the TANDEM or triple mirror and overcomes the problems of a low Q (that is, a large amount of energy stored in the plasma relative to the energy produced) by using two mirror machines at either end of a long cylindrical magnet. By using the cylindrical, or solenoidal, chamber for the actual fusion fuel, it becomes possible not only to use a low magnetic field for the actual power production cycle, but also to confine the destructive effects of the fusion reactions to the cheap and easily produced solenoidal structure rather than the more complex mirror machines.

Extrapolations from recent results from the mirror experiments at both LLL and Novosibirsk in the Soviet Union, predict that a 100 megawatt fusion device would require a chamber only 5 meters long and 1.5 meters in diameter. This sort of device is essential for the study of reactor condition plasmas and needs immediate funding in a larger brute force fusion program. The government's present funding, on the contrary, continues to put off even the simple scale-up of the 2xIIB itself.

ERPI Report Confirms Sabotage of U.S. Laser Development

A report released in November by a team of leading U.S. scientists presents a scathing description of the sabotage of the nation's laser fusion development program. The report, issued by the Electric Power Research Institute (EPRI), corroborates the FEF's charges that the vital program has been systematically undermined.

Coming on the heels of the Soviet international offensive for the development of fusion energy as a cheap and abundant source of power for world development, the EPRI document is a political bombshell.

Security classification of vital data has hogtied the program, the report charges, and "means that the flow of information and hence the rate of scientific innovation is significantly retarded." It also scores U.S. refusal to permit, let alone encourage, active scientific collaboration with other countries. Unless the obstacles of classification and underfunding are removed, the EPRI report concludes, "demonstration of scientific feasibility is doubtful."

The significance of the EPRI report,

titled "Assessment of Laser-Driven Fusion," was underlined by the U.S. Energy Research and Development Administration's attempt to prevent its publication, using "security" as the pretext. The report was completed last March, but had been sat on by ERDA until mid-November. Even after its release to the public, the only press coverage given the report until now was a mention in a recent issue of *Business Week*.

Political Coverup

FEF first learned of the report's existence last March when Dr. Ray Kidder, a leading laser fusion theoretician at ERDA's Lawrence Livermore Laboratory, was asked whether he had received the questionnaire on the status of fusion research which was then being circulated by Senators Tunney and Metcalfe. The questionnaire had been written in collaboration with members of the FEF research and development staff. "Yes indeed," Dr. Kidder said, "and it came just at the right time; I've just helped complete a report for EPRI

on laser fusion." Later FEF learned that ERDA was delaying release of the EPRI report due to "security considerations." (Meanwhile the results of the Tunney-Metcalfe questionnaire have never been made public.)

It is believed that the release of the report now was forced by the eruption of the so-called "Rudakov scandal" throughout the U.S. scientific community. When this summer a leading Soviet fusion scientist on tour in the U.S., L.I. Rudakov, unilaterally declassified important material on the USSR's electron beam fusion research, which also directly applies to laser fusion, to a group of U.S. researchers, ERDA responded by impounding the blackboard on which Rudakov had explained his disclosures and attempting to forcibly prevent any publication or even discussion of Rudakov's revelations. The Fusion Energy Foundation and the U.S. Labor Party exposé of ERDA's Gestapo tactics of suppression sparked outrage among U.S. scientists, which ERDA now apparently has decided not to intensify by covering up the EPRI report any longer.

EPRI is a West Coast-based institute which is a leading representative of pro-growth industrialists from the aerospace, nuclear, and public utilities sectors. It is the major source of private grants for U.S. fusion research, and is currently working with the Soviet Union on the development of the Soviet T-20 Tokamak prototype fusion reactor. Among the top scientists who worked on the EPRI report are Keith A. Brueckner, former director of laser fusion theory for KMS Fusion, Rolf W. Gross of the Aerospace Corporation, and James H. McNally, the former head of the ERDA laser office.

U. of Miami Reports Progress with Plasmoids

Plasma physicists from the University of Miami reported in a paper prepared for the November meeting of the Plasma Physics section of the American Physical Society that they have achieved experimental results in the containment of plasmoids. The results portend the use of these plasma structures in nuclear fusion devices.

These results are the first important experimental advance in three years in a line of research into plasmas which attempts to take advantage of the self-generated stable structures which a plasma produces, and represent a significant advance toward the creation of fusion as the energy source for world economic development in the immediate period ahead.

The small plasma physics laboratory under the direction of Dr. Daniel Wells at the University of Miami has been experimenting for almost a decade on a smoke-ring-like structure which is created in a plasma gun, a plasmoid, whose remarkable properties of

stability and internal ordering of fields and plasma have made it important from a scientific point of view.

Until several years ago the plasma escaped from the compressional magnetic fields which were to be used to transfer energy, thereby heating the plasmoid structure. The most recent results show that these plasmoids can be heated to temperatures of 2 kilo electron volts (about 20 million degrees) at a density of 100 trillion particles per cubic centimeter — this is ten times hotter than the experiment has been able to achieve before and shows very clearly that these plasmoids are stable to external heating.

At this point, the plasmoids have as long a lifetime as the magnetic field that supports them, and Wells plans experiments that will increase by a factor of eight the time that his magnetic fields can be maintained. The experiment is just on the verge of the point where large amounts of fusion reactions will take place, and already, a few fusion-produced neutrons have been detected.

Searing Critique

The introduction of the report describes it as "the most complete, concise, and accurate statement on laser fusion available." After a thorough review FEF fully concurs.

The report begins by noting that "as of this time, production of net power (from laser pellet fusion) with unclassified target designs does not seem likely." It then reviews the history of fusion research: "The controlled ther-

monuclear research (CTR) program of the U.S. was maintained at a relatively low funding level...." until "This situation changed markedly in 1968-69 with the demonstration in the U.S.S.R. with the Tokamak device..."

The report goes on to searingly criticize the major failures of the laser fusion program — the classification of results and the lack of scientific focus and cooperation. Especially critical is the secrecy imposed on the design of the pellet targets of fusion fuel on which laser beams are focused to ignite a fusion reaction. Says the report, "we estimate a low probability of early achievement (CY 76 or 77) of significant thermonuclear burn and believe that demonstration of scientific feasibility is doubtful with the planned laser developments.... The development of laser-fusion has in several instances been retarded by excessive fragmentation, inadequate communication, and poor cooperation among the laboratories."

"There is a definite handicap in the laser-fusion program which is not associated with the CTR (that is, magnetic confinement—ed.) program: classification...means that the flow of information, and hence the rate of scientific innovation, is significantly retarded," the report says. "For example, the academic community is largely unaware of the problems or the information needed in the laser program. The classification of pellet design inhibits engineering analysis of potential reactor designs....The lack of full interchange of ideas with foreign governments will eventually reduce the rate of progress toward laser-fusion reactors in every country."

After reviewing in some detail why laser pellet fusion involves crucial, fundamental physics questions of non-linear effects, the report states, "No laboratory has yet made the measurements required to resolve the present uncertainties in these phenomena....The present experiments on neutron production by implosion of D-T-filled glass shells...are now generally felt to have little relevance to the ultimate goals of laser-driven fusion."

No Contest

The rebuttals by the ERDA managers of the laser fusion research program, printed as an appendix to the EPRI report, serve only to confirm the report's analysis. "We have reviewed the EPRI report and find it to be a fair and constructive report overall," writes Keith Boyer of the Los Alamos Scientific Lab. "There are several statements to the effect that inadequate

funding has held back KMS, NRL (Naval Research Lab), and...Rochester...(See pp. 2-8, 2-14, and 4-9.) To meet all the milestones being projected, funding is inadequate in the entire ERDA Fusion Program and the situation affects all laboratories equally. In fact, Headquarters tries very hard to equalize the pain," confesses J.J. Emmett, the Associate Director for Lasers of Lawrence Livermore.

The EPRI report concludes that if an open laser fusion effort, with full international cooperation, is established, the prognosis for developing laser fusion energy is good, but a definitive judgment is precluded by the present classification of crucial pellet designs. And it strongly recommends that "test reactors must be build in the 1985 period to provide information for the power reactors in the late 1990s."

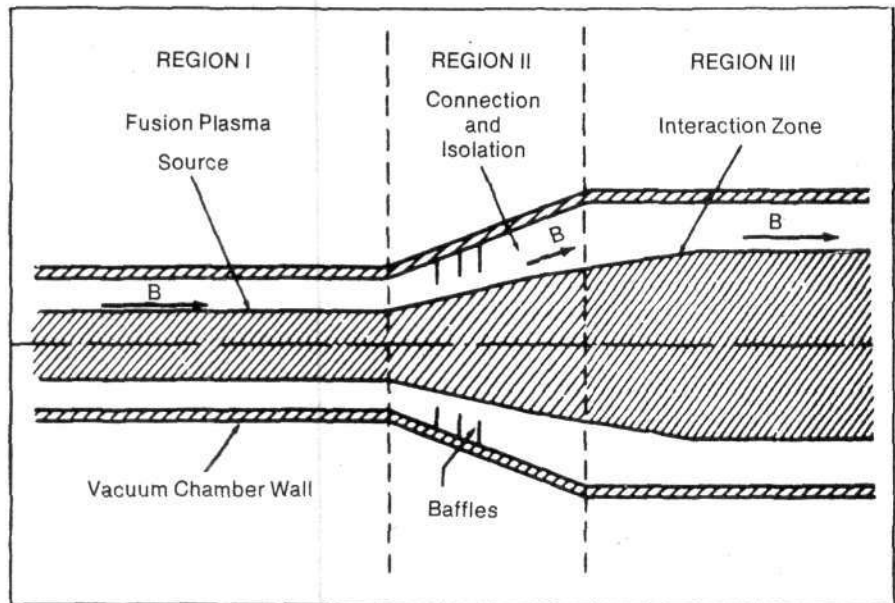

The fusion torch, shown in the above diagram, would permit an advanced utilization of energy to produce finished materials like iron and steel in one-step processing of raw materials.

Fusion Torch Ready For Use in Industry by 1985

The Electric Power Research Institute (EPRI) published a detailed study in December showing that fusion torch industrial applications of thermonuclear energy can be demonstrated by the mid-1980s — 15 years ahead of the Energy Research and Development Administration's schedule for electric power production through fusion reactors. The new EPRI report follows up the release of their earlier report on laser-driven fusion, which conclusively proved that ERDA was undermining and retarding progress in inertial confinement fusion research.

The new report, entitled "Enhanced Energy Utilization from a Controlled Thermonuclear Fusion Reactor," was written by Bernard J. Eastlund, who is currently the director of the Fusion Systems Corporation. Eastlund developed the fusion torch conception in 1968 with William C. Gough who is

currently the director of the EPRI fusion division.

The report concludes that "small reactors based on present physics and technology concepts tend to be inefficient. Synthetic fuels production could significantly enhance the output of such reactors...." It emphasizes that "a pathway to controlled fusion is possible that would have a goal of a small demonstration gas-electricity producer on line in 1988."

Both in a preliminary report issued last winter and in the final EPRI report, Eastlund points out that the kind of research needed for developing the fusion torch is not currently going on. Eastlund concludes that "What is required is a commitment by a responsible funding agency to put some solid underpinning to the physics, chemistry and technology" of fusion torch application.

Attempts to Stop European JET Program Backfire

The European Parliament passed an all-party resolution Jan. 11 reaffirming its commitment to the immediate implementation of Western Europe's thermonuclear fusion research program, the Joint European Torus (JET). The implementation of JET, the prototype tokamak reactor project scheduled for operation in 1980, is the only way to secure the long-term energy needs of the European Economic Community, the Parliament stressed.

The resolution condemned the EEC Council of Foreign Ministers for not having chosen a site for the \$200 million JET research project and urged that the council do so at its upcoming January meeting "to show that the EEC is capable of taking action...in the general interests even if national egoism suffers in the process."

The pressure directed on the EEC occurs as more European nations are openly identifying the U.S. as the benefactor of any sabotage of the European fusion effort. "European patience has a limit and Europe does not intend to sit by and witness the liquidation of the European effort," said Guido Brunner, EEC Energy Commissioner.

Just a month earlier, Brunner's

Gas - Iodine Laser Advances

A West German group of plasma physicists reported a tripling in the power output from their economical gas-iodine laser, making it an attractive energy source for laser-induced fusion, one of the most promising lines of fusion research. In a report at the October International Conference on Laser-Matter Interaction, a group from the Max Planck laboratory announced that the gas-iodine laser is now operating at three times the previous power (about 500 joules within one-half a billionth of a second) and at about 1 percent of efficiency — about three times better than previous iodine lasers.

remarks at a press conference on its "death bed" has sparked a flurry of articles in the world press that JET's impending death would lead to the demise of Europe's overall fusion research effort and that European fusion researchers would have to emigrate to the U.S. to find continued employment. The reports indicated that the Giscard government in France was responsible for the moribund state of JET, since France would not permit a majority vote of the EEC members to decide the location for the project.

But like Mark Twain's celebrated comment, "Reports of my recent death are grossly exaggerated," it turned out that JET is not only alive but that the exaggerated death notices had sparked its supporters into a pro-fusion campaign.

JET in the News

The *London Times* reported Dec. 22 that in what would have been a normally low-keyed parliamentary debate on the future of nuclear power in Britain, there was an explosion on the JET question. The *Times* reported that Tom King, the Opposition spokesman on energy, questioned the government on the status of JET, and Mr. Eadie, Undersecretary for Energy, replied that Brunner's statement at the EEC press conference was an exaggeration.

Prime Minister Callaghan added that "These proposals go through a number of phases and I do not regard that project as dead. I go further and say I believe Britain in the form of its facilities at Culham, the team that is assembled there and the industrial and scientific backup that could be found for it, undoubtedly provides a suitable venue for the development of what could be a valuable scientific innovation in nuclear fusion as distinct from fission." According to the *Times*' report, Callaghan's speech at the mundane parliamentary session was followed by boisterous cheering from the entire gathering.

Next day the *Times* carried an editorial called "the Torus controversy" that pointed out that the whole future of European civilization

"depended on the development of this source of energy." The government and Britain must rise to its "historic responsibility" in developing fusion power, the *Times* said.

Others joined the cry that JET was not only alive but necessarily had to grow. In the Italian Parliament, Minister of Scientific Research Pedini pointed out the necessity of fusion power development in a discussion of JET.

Lord Sherfield located the political aspects of the JET in a speech made in the House of Lords and reported by the *London Times*: "Nuclear energy had become a whipping boy for those in revolt against the consequences of high technology in general and those who wished to or set limits to growth....The government should make Britain's commitment to nuclear power unequivocal...so that expertise build up could be retained, planning and development could proceed and Britain's lead in this field, which it was in grave danger of losing, could once more be regained."

In a subsequent *Financial Times* dispatch on the JET, that newspaper reported that bilateral agreements to advance fusion research would emerge even if the JET program was sabotaged. Reliable sources have indicated that the British and Italians are already cooperating behind-the-scenes to maximize the pace of European fusion development.

Europe as yet lacks the means to fund such fusion projects. But the more successful the Rockefeller crowd is in sabotaging the present fusion program, the more Europeans will be compelled to consider their only alternate source of funds — the USSR.

The Fusion Energy Foundation

is pleased to announce
the formation of a
Life Sciences Division

For information contact

Fusion Energy Foundation
Box 1943, GPO
New York, N.Y. 10001

Coming Soon —
Special Report
on the Life Sciences

Swedish Plasma Physicist: 'Don't Forget Fusion'

The following letter by Europe's leading plasma physicist Bo Lehnert appeared in the Aug. 3 issue of *Dagens Industri*, the biweekly business and industrial news magazine of the Swedish Bonnier publishing house family.

Dagens Industri stepped up its campaign for East-West trade and fusion power with a full page article the same week entitled "European Fusion Research Gives Sales Chances for Swedish Industries." The article specifically shows how Swedish industry fits into the international picture of fusion development. *Dagens Industri* also published a defense of East-West trade, counterattacking those Swedish shipping companies that criticized a transport agency for "treason" because it was cooperating with the Soviet Union.

Lehnert is a professor of plasma physics at the Royal Swedish Institute of Technology in Stockholm. He wrote his letter in reply to the wind and solar energy program being pushed by Palme scientist Hannes Alfvén and entitled it, "Don't Forget Fusion Power: It Can Solve Our Energy Problem — Wind and Solar Cannot."

"In an interview in *Dagens Industri*, No. 22, my friend and colleague, Hannes Alfvén has among other things said that fusion power should be dropped from the ongoing energy debate, first because it is not feasible for a very long time and further because it is not safe from the standpoint of environment and security. Instead, Alfvén makes himself a spokesman for a better utilization of present energy forms as well as a push for solar and wind-power.

"In looking into these questions more closely, it should first be clarified what the basic possibilities every energy source must meet in order to have a practical effect on the overall energy supply. First, a large amount of energy must be available in an economical way to be extracted in a usable form (electricity, heat, etc.) Secondly, security risks and environmental effects must be at an acceptable low level. Third, the state of research and development must allow a practical use of other energy sources during this development period.

The Advantage With Fusion Energy

"A look at the present and future energy resources shows that the long term global energy need could be met only through one or several of the alternatives of fossil fuels, fission (in breeder reactors that convert fuel), fusion power, solar, and geothermal energy.

"Regarding security and environmental problems, the breeder reactor requires further investigations. The fusion reactor has several inherent advantages, since the fuel does not give off radioactive "dust," in the container material can be chosen in order to maintain radioactivity on a low level, plutonium is not needed in the process, uncontrolled chain reactions are impossible, the reactor can be momentarily stopped and emergency cooling will probably not be needed. Solar energy from an environmental standpoint has obvious advantages, however solar power's extremely large collecting area is no trivial problem.

"The state of research and development for fusion is less advanced than for the breeder reactor, but despite certain remaining problems, it is significantly more advanced than for power stations based on solar and geothermal energy. Large scale and economical production of electric power from sunbeams is a debatable possibility which seems to have to be put into the indefinite future.

"With its more or less unlimited energy supply and its advantage from the security and environmental standpoints, fusion power can well turn out to be the ultimate solution for the global energy supply. Therefore, you cannot push aside this important alternative from the current debate while at the same time emphasizing the importance of solar and wind power. Wind power is not sufficient as a global energy source. When it concerns energy production on a large scale, solar energy is much further from the solution than fusion power. Further, fusion is important because it makes possible energy production without producing plutonium."

Dagens Industri

Redaktionsledning
Chefredaktör och ansvarig utgivare
Boris Torsvall
Sektionschef: Eva Nordqvist
Andra redaktörer: Håkan Hedberg
Ekonominstitutets huvudredaktör
Arne Larsson
Säkrhetschef: Lars Hultman, Hans Westin
Redaktion: Birger Isaksson, Irene Ohlsson



Swedish plasma physicist
Bo Lehnert: "Fusion
power can well turn out
to be the ultimate
solution for the global
energy supply."

**Bo Lehnert till angrepp mot Hannes Alfvéns energi-linje:
Glöm inte bort fusionskraften:
Den kan lösa våra energiproblem
— det gör inte solen och vinden**

FEF NEWS HIGHLIGHTS

FEF National Campaign:

Repeal the National Environmental Policy Act of 1969!

The Fusion Energy Foundation has opened a nationwide campaign to repeal the anti-technology National Environment Policy Act of 1969 (NEPA), working in cooperation with the U.S. Labor Party and the Labor Organizers Defense Fund. The campaign was announced in a joint statement issued Jan. 15 by the heads of the three organizations.

"NEPA has probably done more to undermine this country's fundamental commitment to technological progress than any other piece of legislation," a spokesman for the three groups said. "Under NEPA and related procedures, every important energy project and infrastructural development has been subject to years of sabotage and delays. The lead time for the construction and operation of nuclear power plants has been extended by at least four years, if such plants get built at all. Industrial development, energy production, and transportation have all been decimated by NEPA."

The subversive nature of NEPA was freely admitted by one of its authors, Professor Lynton Caldwell. According to Caldwell: "NEPA implies a major modification and even a reversal of

long-established priorities in the political economy of the nation. The disruptive effects of the business-as-usual economy do not appear to have been foreseen by the Congress....The values of NEPA correspond to those advocated by proponents of planned or restricted growth."

The Labor Organizers Defense Fund is now drafting a bill for the repeal of NEPA which will be presented to the U.S. Congress (and to state legislatures for memorialization) as a companion piece to the proposed Fusion Energy Research and Development Act of 1977.

The FEF - Labor Party - LODF alliance is also mapping out a number of critical legal battles to crush the Ralph Nader movement, an artificial creation of the Rockefeller family and their foundations and legal fronts.

"NEPA has already done irreparable damage to the U.S. economy by giving these Naderites free rein to sabotage technology under the guise of protecting rocks and clams," a spokesman for the three groups said. "By repealing NEPA and coalescing a pro-growth, multipartisan energy coalition we will be taking a major step toward restoring those values upon which this country was originally founded."



FEF physicist Steven Bardwell speaking to a Stockholm audience during his fall 1976 European tour. Bardwell's tour took him in Belgium, France, Italy, Sweden and West Germany, where his fusion forums in seven major cities drew crowds of more than 100 participants. Bardwell also attended the IAEA conference as an official U.S. representative.

Labor Party Circulating 'Memorial on Energy Policy' to State Legislators

The U.S. Labor Party is circulating the following "Memorial to Congress on Energy Policy" to state legislators across the country. At this writing, the memorial, which calls for the rapid development of fusion power, has been submitted by legislators to the drafting committee of the state legislature in Wisconsin and Colorado and to the energy committee in Washington state. In addition, lawmakers in Maine, Maryland, Massachusetts, New Jersey, Oregon, Pennsylvania, and Vermont are now considering introducing the memorial. For up-to-date information on your state, contact the FEF.

"The United States has a unique role to play in the world as a leading force for scientific and technological innova-

tion and advanced agricultural and industrial production. The rights and responsibilities this involves were secured through hard-fought battles in the American Revolution up through the Civil War.

"Yet, at this time, there are policy-makers, especially those grouped around the Brookings Institution, the Rockefeller Foundation, the Trilateral Commission, and similar agencies, who, through their adherence to zero-growth and other form of austerity on behalf of what are known as monetarist policies, would act to subvert the historic American economy by implementing programs of retrogressive energy forms, employment of skilled labor and youth on "public works" at

below subsistence wage levels, and the dilution of education into "sensitivity" and sub-literary training.

"Threatened in particular by the onset of such de-industrialization policies are the technical abilities that define us as a modern, industrial nation — the aerospace, electronics, and related sectors. If the workforce, research and development capacity, and industrial infrastructure of these sectors are permitted to deteriorate either through a deliberate dismantling policy or through defense expenditure vicissitudes, then all lower levels of technology including metalwork, industrial chemicals, and the rest, will be in jeopardy because the nation's capability for the most advanced re-



Left: FEF Director Dr. Morris Levitt addressed 400 California business leaders at the Comstock Club in Sacramento Feb. 14. Levitt called for industry to stop being "intimidated by the lower species of zero-growthers who love the clam and the lousewort better than man and "have the courage to forcefully assert" a policy of expanded energy output and industrial progress.



Dr. Morris Levitt at Colorado's regional FEF conference in October with, from right to left, Clarke Watson, chairman of the Colorado Black Political Caucus; Don Shaputis, president of the International Brotherhood of Electrical Workers local 111, and Tony Richter, the mayor of Thornton, Colorado.

tooling and design will be lost.

Therefore, we call on Congress to prevent such a course of action inimical to the nation's future and to mankind by implementing policies of industrial research and development and the development of the advanced energy form — controlled nuclear fusion power.

1) Energy: Congress will undertake the necessary enabling measures to accelerate and broaden the research and development of controlled fusion reactions.

2) Congress will enact complementary enabling measures to develop fossil fuel usage and nuclear energy expansion under existing technologies to bridge the period between now and the target period of the mid-1980s when controlled fusion energy can come on line.

Advanced Technology

1) Congress undertakes to foster the expansion and development of the aerospace, electronics, computer and related sectors by measures including the following:

a) Development of the scientific and engineering knowledge essential for bringing on line controlled fusion reactors.

b) Development of this sector in connection with revitalizing the machine tool industry to in turn tool up outmoded American industry in all lines of basic manufacture, transporta-

tion technology, agricultural production, and food and fiber processing.

2) Congress will enact measures required to strengthen basic scientific education for the population in the fields of physics, chemistry, biological research and agronomy, as well as engineering and related professional skills.

Levitt Reviews Fusion Future for Washington Diplomats

A broad cross-section of the Washington, D.C. scientific attaché corps turned out Dec. 7 for a special review of the status and prospects for fusion power development presented by Dr. Morris Levitt, FEF Director. The governments of France, Japan, Australia, and Romania from the advanced and Comecon sectors, and Indonesia, Egypt, Zambia, and Argentina from the non-aligned and developing sectors were officially represented at the seminar.

Levitt stressed that recent fusion research results, which placed magnetic and inertial confinement

devices at the threshold of net energy production, were the direct result of the increase in resources and international cooperation applied to the scientific and technological problems in the last decade. He called for intensification of the trend to funding levels of at least \$10 to \$20 billion yearly. Special provisions for participation of the Third World, particularly in basic research, Levitt concluded, are now absolutely essential for basing the new world economic order on a development program geared to the transition to an international fusion-based economy.

Baltimore Conference Draws Industrialists, Scientists, and Workers into Policy Discussion

The high turnout at two lively September conferences in Baltimore and in Washington, D.C. underscored the failure of the recent coordinated efforts by Edward Teller, the Hoover Institute's Stepan Possonyi, and officials at the Energy Research and Development Administration and Defense Department to contain the political impact of the FEF on the U.S. scientific and industrial community.

Business and technical participants at the Baltimore conference included engineers from Baltimore Gas and Electric, the Institute of Electrical Engineers, the Maryland Drydock Shipping Company, Black and Decker, and the Society of Manufacturing Engineers, as well as an architectural engineer. More than \$350 was raised in contributions.

The conference was keyed by Alan Daneahan, vice president of the city's Economic Development Corporation and the mayor's official representative to the conference: "Despite the differences in the political and philosophical views...none of this is of interest to the city of Baltimore. What is of interest to us is the impact that fusion energy, near or remote, may have for the technological and industrial development of this city....Will it work," Daneahan questioned, citing the city's initially successful pyrolysis plant project for garbage recycling which was scaled up to a full-scale unworkable model.

with the epidemiological consequences of failure to pursue the necessary

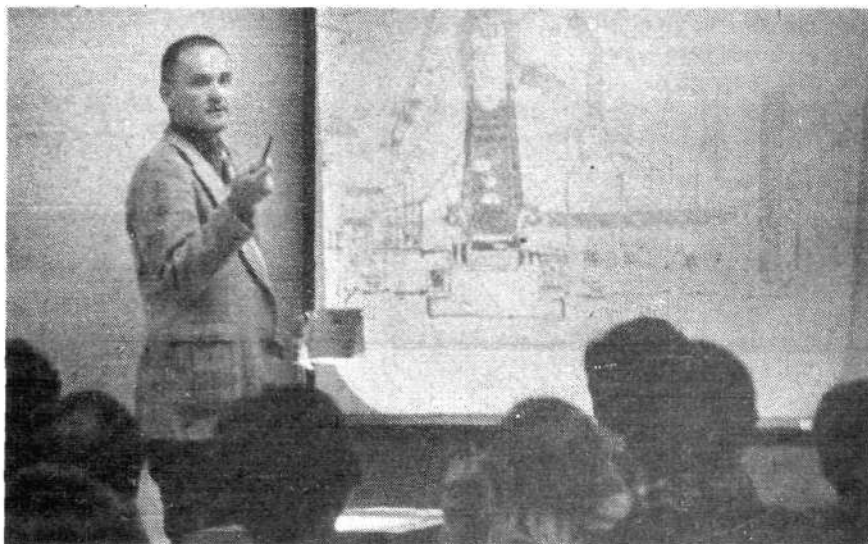

Nuclear engineer Jon Gilbertson explains the role of the Jordan Steel Process in the expansion of U.S. industry toward a fusion-based economy at the FEF Baltimore conference.

development policies, stressing that 1976 is a key branch point for growth and development or ecological devolution. His detailed outline of the Ganges-Brahmaputra regional development project under International Development Bank agreements prompted the question: "How can we convince these peasants?" "We will turn the Third World into one big farm and into one big school at the same time," said Lerner.

FEF nuclear engineer Jon Gilbertson presented the industrial development projects for the advanced sector, fo-

cus on the conversion of conventional blast furnaces to the Jordan process which paves the way for the transition to a fusion-based economy. "In ten years hence," Gilbertson said, "the fusion torch will allow for the direct reduction of iron, and industrial complexes will be established using integrated production processes with fusion as their energy source."

Presenting the theoretical bases for fusion in his talk of nonlinear plasma phenomenon, FEF Director Dr. Morris Levitt discussed the joint FEF-U.S. Labor Party Fusion Energy Research and Development program for educating scientists and building the R and D facilities for the development of all conceptual designs for commercial fusion energy production. He opened the dialogue on politics versus science with an analysis of the ERDA-Teller harassment of collaborators of the FEF's *International Journal of Fusion Energy*.

Why Politics?

"Why not just a concern for fusion energy without getting into politics," one engineer asked. "Aren't you concerned that close association with the Labor Party won't help the FEF?" "Our objective is to get the world in shape," said Dr. Levitt.

The debate was carried through the presentation by Labor Party executive

FEF Testifies at ERDA Boston Hearings

Testimony by FEF Director Morris Levitt injected some reality into the staged hearings in Boston of the Energy Research and Development Administration on its National Energy Plan. The Nov. 29-Dec. 1 hearings were set up as a pseudodebate between ERDA's "big energy" bureaucrats and the manipulated proponents of regional energy self sufficiency and labor-intensive

The ERDA energy plan in essence calls for regressive shale oil and coal gasification schemes.

Levitt's testimony followed panel discussions on two of the most distorted issues at the hearings — nuclear energy and advanced energy systems. The first was set up to feature anti nuclear

countergangs accusing ERDA of forcing fission power onto pure, little New England. Levitt exposed ERDA's complicity in sabotaging nuclear power as well as the "environmental" opposition. He then proposed that fission be properly viewed as part of a one-to-two-decade transition to fusion through economical use of light water fission reactors and the fusion-fission hybrid breeder reactor.

On the final day of the ERDA meeting, Levitt presented an invited review of fusion development to one of the major sessions of the Systems Engineering Conference of the American Institute of Industrial Engineering meeting in Boston.

Uwe Parpart: "There has been no significant period in history when those men who developed key scientific and philosophical ideas did not also actively participate in formulating key political ideas" like Thomas Gresham in Tudor England and Ben Franklin during the American Revolution, Parpart said.

"Progress of the human race was the conscious policy of those governments....The gap between science and politics is only of recent origin. Why don't you know anything about the leading scientific questions? How can you make serious policy decisions without this knowledge?" The USLP proposed debt moratorium, "a time — honored tradition," Parpart continued. "Debt moratoria now by leading Third World countries will have the same significance as other momentous occasions in history."

"But what does a debt moratorium have to do with financing a worldwide program for fusion power," asked the Baltimore Gas and Electric engineer. "How do we know that we will be paid back?" "Through the provision of credits for the development of industrial infrastructure and trade, after the debts have first been written off..." So

Chase Manhattan is only piling good money after bad," the engineer interrupted.

The Washington, D.C. conference the next day began with a press conference by Dr. Levitt to several major professional journals, including *Nucleonics*, *Public Energy Fortnight*, *Professional Engineering Magazine*, *BNA Publications*, Observer Publishing Co. and the Congressional Information Bureau and *Energy Newsletter* of the U.S. Information Agency. In addition to press representatives, the FEF conference included government and health officials representing the the American Association of Medical Colleges, Walter Reed Research Center, the University of Michigan Public Health School, the Health, Education and Welfare's Office of International Health, the Grange Society, Pan American Health Organization, and Naval Oceanic and Atmospheric Administration.

Discussion after Levitt's presentation ranged from how the Soviet Union gained its present mastery in science over the U.S. to the problems of introducing the high technology of a fusion-based economy into peasant societies.

European Labor Party Issues Program for Fusion Energy

The European Labor Party announced Dec. 1 from its headquarters in Wiesbaden, West Germany the release of a comprehensive proposal for an aggressive European fusion research and development effort. The document was developed in cooperation with the FEF. As the first part of the Labor Party's overall energy platform, it presents the core of the party's program for European energy development.

The European Labor Party will use its fusion proposal to focus the fight now raging in Europe over the new world economic order onto the issue of long-term economic program. The mass circulation document is being issued in English, German, French, and Italian, and will also be distributed in scientific and political circles throughout Europe and the Third World.

The Newsletter is a bimonthly publication of the Fusion Energy Foundation featuring news and analysis of major developments in the fusion field. It is the only periodical on fusion geared to keeping both laymen and specialists abreast of international fusion news.

Fusion Energy Foundation Newsletter

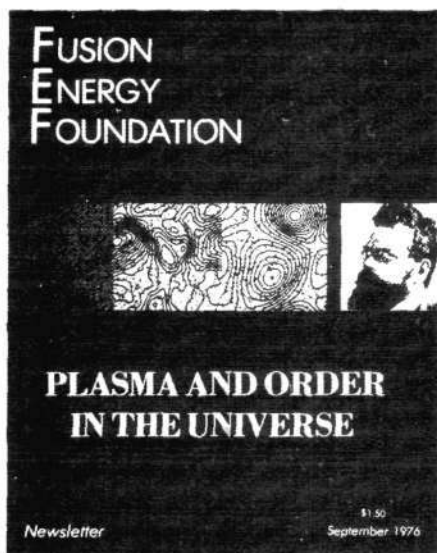

The September 1976 issue of the Newsletter features two essays that definitively remove the basis for reliance on plasma "equilibrium" criteria for fusion research: **Linearity and Entropy — Ludwig Boltzmann and the Second Law of Thermodynamics** by Dr. Morris Levitt and **The History of the Theory and Observation of Ordered Phenomena in Magnetized Plasmas** by Dr. Steven Bardwell.

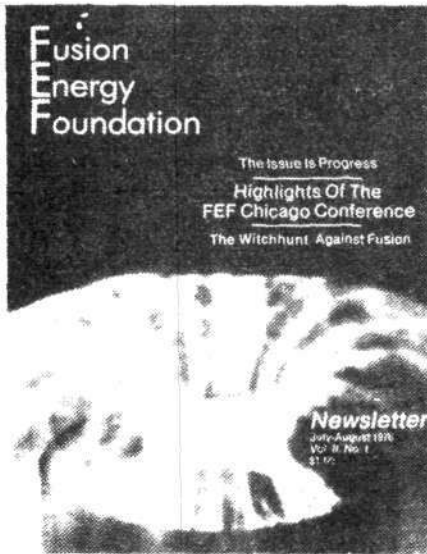

"The Issue Is Progress" is the theme of the July-August 1976 issue, which includes excerpts from the presentations at the historic FEF June 1976 conference in Chicago on **World Development and the Transition to a Fusion-Based Economy**. The issue also features excerpts from the FBI and ERDA's censored documents concerning the FEF.

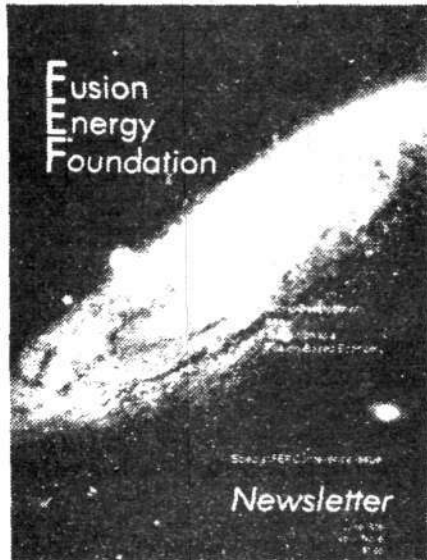

The June 1976 issue includes the first article in Dr. Bardwell's three-part series on plasma physics, plus excerpts from articles on fusion development by the Swedish fusion scientist, Dr. Bo Lehnert, and the Soviet scientists, P.L. Kapitsa and V.N. Tsytovich.

Enclosed is my check for \$ ___ to cover:

- FEF Newsletter subscription (6 issues) - \$10
- FEF Annual membership plus newsletter subscription - \$25
- Back issues - \$2 each, postpaid

 (Please write in quantity and date of issue(s) ordered)

NAME _____
 ADDRESS _____
 CITY _____ STATE _____ ZIP _____

make checks payable to the **Fusion Energy Foundation**
 Send check and completed form to:
 FEF Newsletter, Box 1943, New York, N.Y. 10001