

# FUSION

SCIENCE • TECHNOLOGY • ECONOMICS • POLITICS

November-December 1984

\$2.50/<sup>\$2.75</sup>  
IN CANADA

SPECIAL  
REPORT  
You Can Live  
To Be 100!

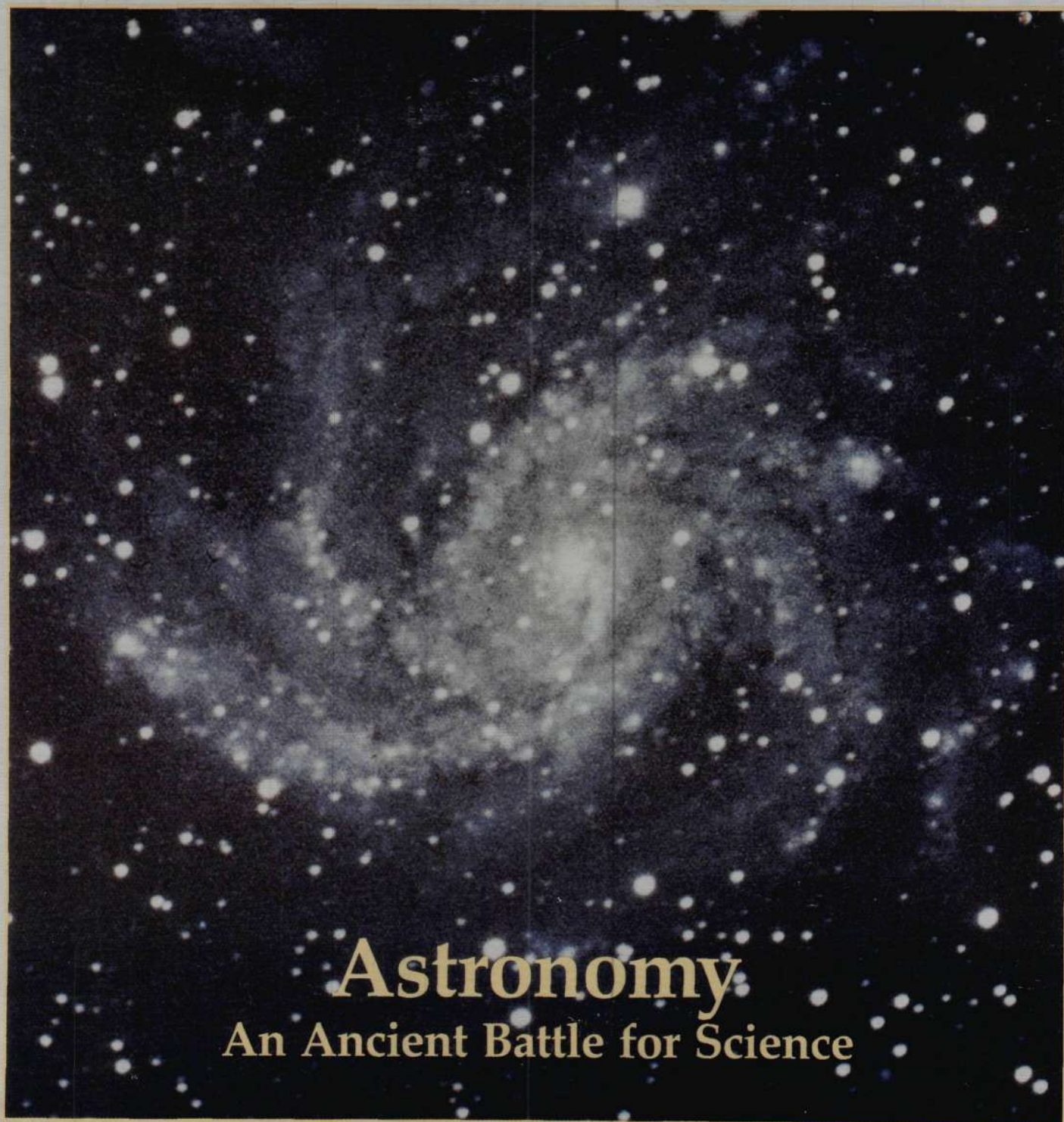

## Astronomy

An Ancient Battle for Science

*This  
Holiday  
Season,  
Give the  
Greatest  
Gift of  
All...*

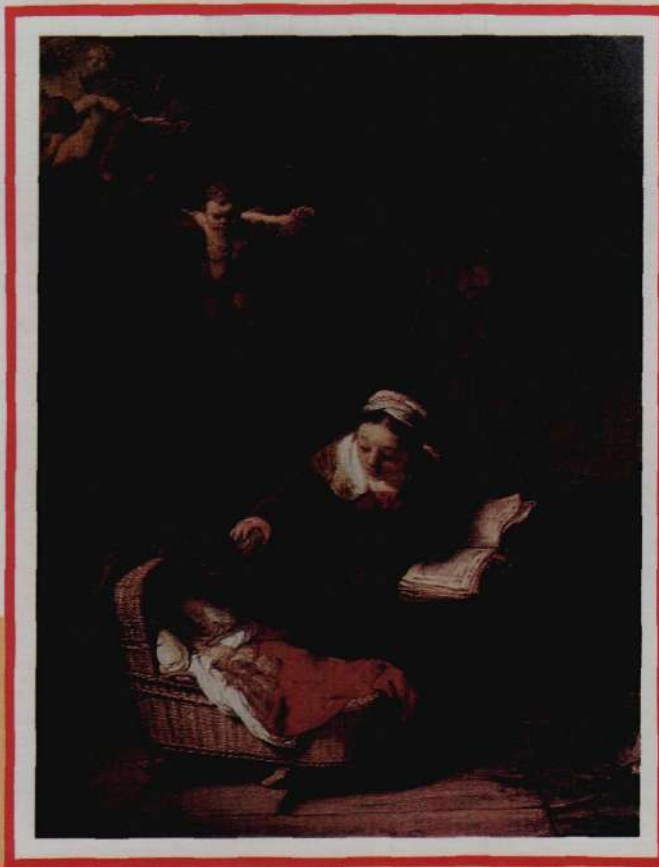

## *The Power of Ideas*

Books by Lyndon H. LaRouche and associates, guaranteed to make whoever reads them **think**. What better could you wish your loved ones this holiday season?

*Special holiday offer—four books for only \$25.95*  
(Postage included.)

**LaRouche: Will This Man Become President?**

by the editors of Executive Intelligence Review.

A biography of the world's most controversial political figure.

\$4.95

**There Are No Limits to Growth**

by Lyndon H. LaRouche, Jr.

A refutation of the arguments of the Club of Rome. \$4.95

**The Hitler Book**

edited by Helga Zepp-LaRouche

The philosophical roots of National Socialism, and the international networks that put Hitler into power and exist to this day.

\$9.95

**The New Dark Ages Conspiracy**

by Carol White

An exposé of men like Bertrand Russell and H.G. Wells, the grandfathers of today's anti-science movement. \$4.95

**Please allow five weeks for delivery.**

- Enclosed is \$25.95 for the set of four, postpaid.  
 Instead of all four books, I am ordering only the books whose titles are circled above. I enclose \$ \_\_\_\_\_  
 (Add postage: \$1.50 for first book, \$.50 for each additional book.)

Ship to:  
Name \_\_\_\_\_

Address \_\_\_\_\_

City \_\_\_\_\_ State \_\_\_\_\_ Zip \_\_\_\_\_

Phone (     ) \_\_\_\_\_

Please enclose gift card which reads:

Seasons Greetings from \_\_\_\_\_

to \_\_\_\_\_

Mastercard/Visa # \_\_\_\_\_

Exp. Date: \_\_\_\_\_ Signature \_\_\_\_\_

Send check or money order to:

**The New Benjamin Franklin House Publishing Co., Inc.**

304 West 58th St., 5th floor

Dept. 3

New York, N.Y. 10019

(212) 247-7484

# FUSION

SCIENCE • TECHNOLOGY • ECONOMICS • POLITICS

Vol. 6, No. 4 November-December 1984

## Features

- 19 Beam Defense Works!**  
**A Point-by-Point Refutation of the SDI Critics**  
*Paul Gallagher*  
Everything you need to know to convince any sensible person that beam-weapon defense will make nuclear weapons obsolete.
- 32 Astronomy: The Foundation of Scientific Method**  
*Jonathan Tennenbaum*  
The ancient science of astronomy must be revived to educate the population and defeat astrology, the secret weapon of the oligarchy in its age-old war on reason.
- 42 How the Universe Is Created**  
*Carol White*  
A Mexican astronomer has extended Kepler's method to relate the mass and spin of astronomical objects over 40 orders of magnitude.
- 51 Food Irradiation**  
**A Technology Ready for a Production Boom**  
*Marjorie Mazel Hecht*  
There is a cheap and efficient way to expand the world's food supply—food irradiation. Yet the implementation of this beneficial technology has been stalled by the same Malthusian lobby that has blocked the development of civilian nuclear power worldwide.

## News

- NUCLEAR REPORT**
- 6 Will TMI Unit 1 Ever Reopen?
- SPECIAL REPORT**
- 8 You Can Live to Be 100  
Research on Aging Shows That It's Possible
- FUSION REPORT**
- 11 Japan's Gekko XII Laser Scores  
Major Advances in Inertial Fusion
- 13 Kyoto's Heliotron:  
A Unique Machine with Great Promise
- 16 Krypton Fluoride Laser Fired;  
'New Dawn for Fusion Research'
- 17 Los Alamos Begins Work on Gamma Ray Laser
- THE YOUNG SCIENTIST**
- 58 A Preview of NASA's Manned Space Station

## Departments

- |   |           |    |             |
|---|-----------|----|-------------|
| 2 | EDITORIAL | 4  | NEWS BRIEFS |
| 3 | VIEWPOINT | 61 | BOOKS       |

## EDITORIAL STAFF

### Editor-in-Chief

Carol White

### Managing Editor

Marjorie Mazel Hecht

### Fusion Technology Editor

Charles B. Stevens

### Washington Editor

Marsha Freeman

### Energy Editor

William Engdahl

### Books Editor

David Cherry

### Art Director

Alan Yue

### Photo Editor

Carlos de Hoyos

### Advertising Manager

Joseph Cohen

### Circulation and Subscription Manager

Dianne Oliver

(212) 247-8620

FUSION (ISSN 0148-0537) is published 4 times a year by the Fusion Energy Foundation, 304 West 58th Street, Fifth Floor, New York, N.Y. 10019. Tel. (212) 247-8439. Dedicated to providing accurate and comprehensive information on advanced energy technologies and policies, FUSION is committed to restoring American scientific and technological leadership. FUSION coverage of the frontiers of science focuses on the self-developing qualities of the physical universe in such areas as plasma physics—the basis for fusion power—as well as biology and microphysics, and includes ground-breaking studies of the historical development of science and technology.

The views of the FEF are stated in the editorials. Opinions expressed in articles are not necessarily those of the FEF directors or advisory board.

Subscriptions by mail are \$20 for 6 issues or \$38 for 12 issues in the USA; \$25 for 6 issues in Canada. Airmail subscriptions to other countries are \$40 for 6 issues. Back issues are available at \$5 each, postpaid.

Address all correspondence to FUSION, Fusion Energy Foundation, P.O. Box 1438, Radio City Station, New York, N.Y. 10101.

Second class postage paid at New York, N.Y. Postmaster: Send address changes to FUSION, P.O. Box 1438, Radio City Station, New York, N.Y. 10101.

### Note to Libraries and Subscribers

We apologize for irregularity in our printing schedule, but we assure readers that the only pro-nuclear science magazine in the country intends to continue publishing! Because of financial difficulties, the FEF published only 4 issues of FUSION in 1983. The FEF will now regularly publish 6 issues a year, but only 4 issues in 1984, beginning with Vol. 6, No. 1, May-June 1984.

Subscribers who purchased a 10-issue subscription and those who purchased a 6-issue subscription will receive the number of issues they paid for.

Contributions to the FEF are welcome (and tax deductible).

Copyright © 1984

Fusion Energy Foundation

Printed in the USA

All Rights Reserved

ISSN 0148-0537

USPS 437-370

**On the cover:** Spiral galaxy NGC 6946 in the constellation Cepheus; photograph by the U.S. Naval Observatory, courtesy of NASA. Cover design is by Virginia Baier.

Philip Ulanowsky is the photographer of the model of the ear on the backcover of the September-October issue. His name was inadvertently left out of the credit column.

# Throwing Away the U.S. Technology Lead

Since World War II, the United States has been the recognized world leader in theoretical science and industrial technology. This nation proved in the 1960s that with a national commitment and sense of mobilization it could overcome an impressive Soviet lead in space technology, leaving other countries behind in the dust. In defense, the United States has worked with its allies in Europe to protect Western civilization from any military threat.

Today, however, we are facing the nearly inconceivable situation where the Western world could be held hostage to Soviet military threats because our directed energy beam weapon defense program is lagging. The paltry \$1.8 billion requested by the Reagan administration for strategic defense has been chopped to \$1.4 billion by Congress.

Allowing for inflation, the appropriation for beam weapon research and development represents *no* increase over the spending levels projected before President Reagan made his March 23, 1983 speech proposing to make nuclear missiles obsolete. The question now is whether the President will use his landslide election victory as a mandate for an Apollo-style ballistic missile defense effort, or whether the Soviets will have the first beam defense system in the world.

## Stepping Down in Technology

The United States has been the leader in civilian fusion energy research for the past decade. Yet the ambitious and feasible plan to lead the world in the development of commercial fusion power plants is fast disappearing. Goaded by the refusal of the administration to move toward power plant engineering development and by Capitol Hill hysteria over budget deficits, Congress has slashed the magnetic

fusion energy budget by \$43 million. At this rate, our only hope for having this cheap, clean, and plentiful energy source is if the Japanese build plants that the United States can import at the turn of the century.

Fusion is not the only frontier science area where budget realities have squashed dreams of development; laser and plasma technologies are another example. In July, the Soviet Union announced the establishment of its first national plasma technologies center at Novosibirsk in Siberia. Plasma guns and other devices for materials processing are being mass produced there for large-scale introduction into industry. In contrast, U.S. industry does not have the economic wherewithal to use the laser and plasma technologies that are already available, and the U.S. government has made no effort to transfer new defense-developed technologies to the commercial sector.

To take other vital areas of technology development: If the United States wants to have nuclear breeder reactors, it will have to import them from France—if national policies continue in the current direction. And in the area of transportation, local governments here are now considering purchasing magnetically levitated trains from Japan or West Germany to improve their rotting urban transport systems with the most advanced technology.

Four more years of policymaking on the basis that this nation does not necessarily have to be "number one" will leave the West defenseless both in military and economic terms. The opportunity exists to reshape the policies of the second Reagan administration and restore the United States to a first-rate position in science and technology. Not to take this opportunity could cost us our future.

## Krafft A. Ehrlicke

It is with great sadness that we report the death of space scientist Krafft A. Ehrlicke on Dec. 11, 1984, as this issue goes to press.

A man of exceptional vision and spirit, Ehrlicke devoted his life to developing the means by which man could conquer and colonize space.

We are proud to have published some of his pioneering work on colonizing the Moon, and we look forward to continuing his mission by helping to publish the work Ehrlicke was just completing, *The Sev-*

*was just completing, The Seventh Continent: Industrialization and Settlement of the Moon.*

For more than 40 years, Krafft Ehrlicke fought tirelessly to create and advance man's knowledge and to prove, through his work, that there are no limits to growth. What better tribute to his memory than for us to rededicate ourselves to complete the task he set for himself—advancing the frontier of science and technology to create a better world for mankind here on Earth and throughout the solar system.

# Viewpoint

The possibilities for food irradiation are unlimited and exciting. One quarter of the world's harvested food is now lost to spoilage and waste. Food irradiation could vastly expand our food supply by killing bacteria and insects in harvested food. Besides acting as a possible substitute for EDB and other fumigants, low doses of irradiation eliminate trichinosis in pork and stop the medfly in citrus fruits and the codling moth in apples. Irradiation could also destroy botulinum and salmonella in red meats, poultry, and fish, and extend the shelf life of fresh fruits, vegetables, and grains.

This is why I will reintroduce the Federal Food Irradiation Development and Control Act in the next session of Congress to foster consumer and commercial acceptance of food irradiation. The time is now to promote irradiation and make the needed changes and additions to present law in order to get this technology moving. The prior bill I initiated had 36 cosponsors from both parties, as well as the endorsement of several major national organizations, including the American Medical Association, the National Food Processors Association, the Grocery Manufacturers Association, the National Pork Producers Council, the Association of Seafood Importers, and the United Fruit and Vegetable Association.

The impact of food irradiation as a postharvest treatment could be revolutionary; it could be the most important development in food preservation since the introduction of canning and freezing because it protects food from pests without leaving any residue. Ionizing energy penetrates the food, killing parasites and microorganisms,

*Rep. Sid Morrison, a family farmer who represents the fourth district in Washington state, will reintroduce the Federal Food Irradiation Development and Control Act in the next session of Congress. Morrison, a Republican, serves on the House Committee on Agriculture. This Viewpoint is adapted from his testimony on food irradiation.*

## Food Irradiation: The Time Is Now



by Rep. Sid Morrison

without leaving any harmful residue. The food absorbs only the energy, not the radioactivity. It is physically impossible to induce radiation in food at any of the dose levels now being studied.

Experts agree that food irradiation is safe and wholesome. Severely ill cancer patients, who are highly susceptible to infection from microorganisms, are sometimes served foods sterilized with gamma radiation. These studies have shown no harmful side effects. In fact, food irradiation has been en-



Council on Radiation Applications  
An array of irradiated food—fresh and bacteria-free.

dorsed by the American Medical Association.

A proposed FDA regulation permits limited application primarily for fresh fruits and vegetables up to a dose of 100 kilorads, which is one-tenth the international standard of 1 megarad (1 kilorad = 1,000 rads and 1 megarad = 1,000 kilorads).

### Legislative Provisions

My new bill retains the proposed definition of irradiation of food as a process or treatment and expressly excludes irradiation from the food additive definition. However, FDA would still retain authority to regulate food irradiation for consumer protection.

The bill also provides for ongoing research and development of food irradiation, national uniformity of food irradiation regulations, and further provides explicit authority for leasing of federally owned irradiation source materials to the private sector to ensure an adequate supply while ensuring federal safety and transportation standards.

The bill establishes a Joint Operating Commission to facilitate acceptance of food irradiation. The Commission will operate within the USDA and coordinate and manage currently fragmented research and information exchange efforts. It will also act as a liaison to promote consumer acceptance and private development.

My experience has been that the public in general has an emotional, almost fearful response to food irradiation. I hope that this bill will promote open discussion so that public concerns about the pending use of irradiation can be addressed.

No matter how successful and safe food irradiation proves to be, it will never reach large-scale commercial application unless there is consumer acceptance. The consumer needs reassurance from the federal government, and I view the Joint Operating Commission as the least restrictive way to facilitate public acceptance.

The importance of federally sponsored R&D cannot be overstated, since it is only because of the 40 years of

*Continued on page 60*

## News Briefs

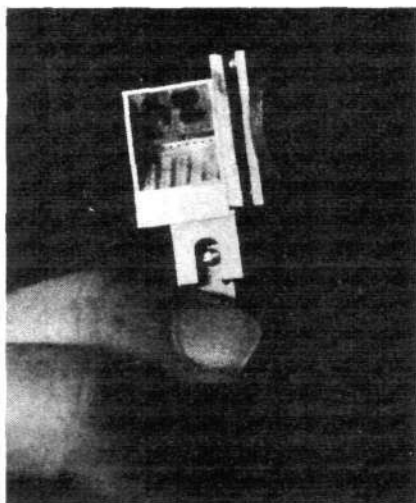

Lawrence Livermore National Laboratory  
A "target" used to make the soft X-ray lasers. The aluminum frame is about 1 inch by 1/2 inch. A metal-coated film is stretched across a gap in the frame. The laser light is focused to the central 150-200 microns of the film.

### LAWRENCE LIVERMORE MAKES 'SOFT' X-RAY LASERS

Researchers from Lawrence Livermore National Laboratory announced Oct. 29 that they had succeeded in producing soft X-ray lasers from the hot vaporized gases of the metals selenium and yttrium. The wavelengths were the shortest at which amplification had ever been observed in a laboratory, the yttrium at 155 angstroms and the selenium at 209 and 206 angstroms. These wavelengths are 25 times shorter than visible light and 5 to 10 times shorter than wavelengths of commercial lasers.

The soft X-ray lasers use a powerful pulse of visible green light from the Novette laser aimed at a thin metal-coated film held in a frame the size of a postage stamp. The energy from the green laser vaporizes the film and strips all but 10 electrons from each of the energized metal atoms. When the first excited atoms spontaneously relax from their energized states, they emit X-rays that stimulate other ions to emit identical X-rays. This amplifies the original input to produce a coherent, increasingly bright X-ray pulse traveling along the length of the film.

The soft X-ray laser will have a revolutionary impact on science and medicine, making possible microholographs that can "see" living processes on a molecular level without damaging the living tissue. The laser will also make possible scientific measurements, now difficult or impossible, of various physical properties, as well as the production of compact circuit patterns on semiconductors. Lawrence Livermore is also studying "hard" X-ray lasers powered by nuclear explosives to serve as antimissile beam defensive weapons.

### DOD ANNOUNCES BREAKTHROUGH IN LASER PROPAGATION

Optical phase conjugation may compensate for distortions produced in laser beams propagated through the atmosphere so that ground-based lasers could attack ballistic-missile targets in space, according to remarks by Robert S. Cooper, director of the Defense Advanced Research Projects Agency, in the Sept. 24 issue of *Aviation Week & Space Technology*.

Optical phase conjugation is a nonlinear effect in nature. In one example, stimulated Brillouin scattering, a liquid backscatters a high-power incident beam so as to reflect a divergent, unfocused beam into a convergent and focused beam, which then interacts with the liquid to establish an acoustic shock front. This shock front backscatters the beam with a frequency down-shifted by the frequency of the acoustic wave. The phenomenon demonstrates the fundamental electromagnetic character of sound production.

As a result of its ability to correct for distortions, Cooper argued that optical phase conjugation would also reduce the required precision of fabrication of high-energy laser optical components from a small fraction of a wavelength of the generated laser light to many wavelengths, perhaps even many tens of wavelengths. One effect of this application would be to reduce the precision to which space-based mirrors need be machined. One argument against beam defense has been the claim by Kosta Tsipis of MIT that the required precision would never be attained. Cooper's remarks, however, indicate that combined with optical phase conjugation present technology will suffice.

### EHRICKE PRESENTS LUNAR INDUSTRIALIZATION PLAN TO NASA MEETING

Space scientist Krafft A. Ehricke gave the banquet address at a Washington, D.C. conference on a manned return to the Moon sponsored by NASA Oct. 29-31 at the National Academy of Sciences. "If God had wanted man to go out in space, He would have given him a Moon," Ehricke quipped, at the beginning of his talk on the industrialization of the Moon. He received a standing ovation from the audience of scientists, former astronauts, engineers, and NASA administrators for his overview of the transport, energy, industrial and human technologies that will have to be developed in order to move our civilization off its home planet.

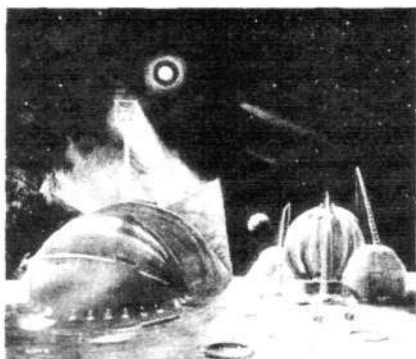

Illustration by Christopher Sloan  
Fusion on the Moon. In his extensive study of lunar industrialization, Ehricke has proposed using large deuterium-tritium reactors as a fuel factory to produce helium-3, potentially one of lunar industry's most valuable exports to Earth markets.

### GREENS LAUNCH DRIVE TO BUILD MOVEMENT IN UNITED STATES

Efforts are underway to establish a Green political movement in the United States modeled on Die Grünen, the Green Party of West Germany, which has recently gained double-digit votes in local elections. In August a group of 62 self-professed anarchists, Aquarians, environmentalists, leftists, and assorted mystics met at Macalester College in St. Paul, Minn. to discuss how to build a Green Party out of the disparate community groups, environmentalist networks, and remains of the 1960s left-radical movement.

Organizers for this effort are working out of offices provided by the Hubert Humphrey Institute in Minneapolis, which served as a policy think tank for the Mondale Presidential campaign. The seed money for the Institute was provided by Henry Kissinger through fundraising efforts in Great Britain.

### JET HITS RECORD FUSION CONFINEMENT TIME

The Joint European Torus (JET) tokamak in Culham, England, has reached record energy confinement times for fusion plasmas in the range of seven tenths of a second—more than double that previously achieved on both the TFTR tokamak at the Princeton Plasma Physics Laboratory and on JET itself. The excellent, early results on JET strongly indicate that this joint effort of the European Community not only will be the first to produce net-energy-producing fusion plasmas, but also could leap ahead of the U.S. machines to reach full fusion plasma ignition. JET's ignition potential is related to its larger size, experimental pulse length, and plasma current, in addition to its emphasis on radio frequency (RF) heaters. The RF heaters, antennas that direct electromagnetic waves into the plasma and increase the plasma temperature, can be used to further extend the pulse length of the experiment, thereby giving more time for the attainment of fusion ignition.

### FEF EXPANDS THE INTERNATIONAL JOURNAL OF FUSION ENERGY

The first edition of the newly expanded *International Journal of Fusion Energy*, to be published quarterly, will appear in January 1985, announced Dr. Robert J. Moon, editor-in-chief. Moon, a member of the Manhattan Project during World War II, is professor emeritus at Chicago University.

Featured in this issue is "The Morphology of the Electron" by Dr. Winston Bostick, "Missing Energies at the Pair Production by Light Quanta," by Dr. Erich R. Bagge, "The Relation Between Angular Momentum and Star Formation in Spiral Galaxies," by Dr. Luis Carrasco, and "New Frontiers in Biophysics," by Dr. James Frazer. The issue also contains reports on progress in several areas of fusion research, astrophysics, and biophysics, as well as translations of two works on electrodynamics, one by Riemann and the other by Betti.

Subscriptions are \$80 for four issues (\$100 foreign) and can be obtained from the FEF.

### LOUSEWORT LAURELS TO EPA'S OFFICE OF TOXIC SUBSTANCES

This issue's Lousewort Laurels award goes to the Environmental Protection Agency's Office of Toxic Substances for its May 23 announcement of a "priority review" of the health effects of formaldehyde in industry. The review was prompted by one study that found that rats got nasal cancer after inhaling 15 parts per million (ppm) of formaldehyde. The industry limit, enforced by OSHA, is 3 ppm, with the vast majority of industry sites at a level far below this. In 75 years, and many studies, there have been no reported cases of such cancer in humans working with formaldehyde. In fact, formaldehyde, a simple chemical composed of carbon, hydrogen, and oxygen, is found everywhere and is produced naturally by plants, animals, and the human body. Formaldehyde is responsible for the "permanent" in permanent press, is an essential ingredient in wood products, and constitutes about 8 percent of the GNP.

Readers can contact the EPA's Office of Toxic Substances at 401 M Street, S.W., Room E 409, Washington, D.C. 20460.



Stanley Ezrol  
Green Party leader Petra Kelly at a 1983 demonstration outside the White House.

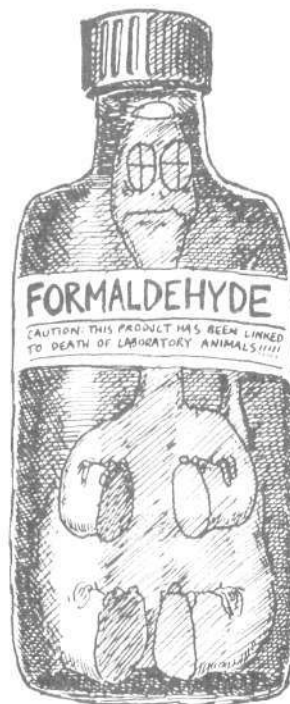

# Will TMI Unit 1 Ever Reopen?



GPU Nuclear

At the time of the incident at the Three Mile Island Unit 2 nuclear power plant in March 1979, Unit 1 was temporarily shut down for routine refueling. Now, after more than five years of antinuclear intervention, this power plant is still closed, and the cost of keeping an operational plant ready but closed—while paying for replacement power—may become an unfeasible burden for the utility.

GPU Nuclear Corporation is now paying \$14 million a month to bring in electrical power to replace the capacity lost while TMI Unit 1 is closed, costing GPU's customers more than \$400 million since 1979. And if the Nuclear

Regulatory Commission (NRC) continues to bow to pressure from the environmentalists and refuses to allow the plant to restart, the doors of Unit 1 might shut for good.

### The Sabotage of Unit 1

There is no legitimate reason that TMI Unit 1, which was unaffected by the damage at Unit 2, is not back in operation. According to GPU Nuclear, Unit 1 could be up and running four to six weeks after a go-ahead from the NRC.

Admiral Hyman Rickover, the founder of the Nuclear Navy, which built the nation's first nuclear power reactor, has done two evaluations of TMI

*Visitors tour Three Mile Island. The environmentalists have spent millions to ensure that the plant stays closed.*

operations. He has stated that "based on the assessment of GPU Nuclear Corporation organization and its senior management GPU has the management competence and integrity to safely operate the TMI-1 plant."

Testifying before the NRC in August 1984, GPU officials said that there is "ample basis" for lifting the 1979 shut-down order of TMI Unit 1.

Since 1979, GPU has spent \$95 million to modify the plant to meet new NRC safety requirements. In September 1984, an NRC staff report stated that Unit 1 is on par with other operating Babcock and Wilcox nuclear power plants in terms of plant modifications. Yet, the NRC is continuing to honor the delay tactics of antinuclear intervenors, which now will put off restart at least past the first of next year. Over the past five years, the intervenors have run from pillar to post to invent new reasons why the plant should not reopen: The plant is unsafe, they said; it would be too "psychologically stressful" to open it; and radiation releases from the damaged reactor have created biological damage to residents in the area. None of these arguments holds any water.

On this last point, the State of Pennsylvania Health Department has carried out exhaustive studies in response to the environmentalists' outrageous claims of health damage from the TMI accident. In 1981, Dr. George Tokuhata, director of epidemiological research for Pennsylvania, stated that articles written by the notoriously antinuclear Professor Ernest Sternglass were "highly inaccurate to the extent of creating unnecessary fear in the minds of Commonwealth citizens."

Charges included an increase in infant mortality rates, which was absolutely refuted by Health Department studies. The same is true for charges of congenital hypothyroidism and birth defects.

Tokuhata summed up his rebuttal of



Sternglass by stating that Sternglass's words in *The Nation* magazine: "have the potential of creating fear, apprehension, stress, and even panic among the residents of central Pennsylvania. This is totally irresponsible and the Department of Health regrets that the public has been subjected to such unfounded statements from Dr. Sternglass."

Unfortunately, there is one area in which the Health Department punted. Tokuhata has stated that during the 1979 TMI accident expectant mothers were under increased stress, and medications were used in excess, including tranquilizers, sleeping pills, analgesics, and cardiac or hypertensive preparations.

This increased use of medication supposedly led to lower birth weight among newborns in gestation during the accident. What Tokuhata does not point out, of course, is that the increase in "stress" was caused by the deliberate exaggeration of supposed danger by so-called experts like Sternglass, by the media, and by Governor Thornburgh, whose inaccurate remarks caused a near-stampede of frightened citizens from the Harrisburg area.

Now the intervenors are claiming that the utility is "incompetent" to run the facility, demanding that all nuclear power plants operated by GPU Nuclear be shut down. This would include the Oyster Creek nuclear plant in New Jersey, in addition to the two TMI units.

That this is more of a witchhunt than any concern for "public safety," was noted by GPU President Herman Dieckamp, who stated a year ago: "I can't help but contrast TMI with the DC-10 that crashed in Chicago, killing over 270 people, a few months after the TMI accident. Nobody called for the dismissal of the top corporate officers. There are no continuing investigations four years later. Why should it be so different for TMI and nuclear power?"

The answer to Dieckamp's question was stated by a spokesman for the environmentalist group "TMI Alert"—in brief, that the postindustrial state of Pennsylvania does not need power plants. "Through conservation and the slowing down of the economy, there is excessive power on the electric grid

in Pennsylvania," the spokesman stated. The trend is for "industry to move to the south and southeast, and this trend will continue."

#### Then and Now

After the 1979 TMI incident, the Fusion Energy Foundation went on the offensive against the antinuclear movement, exposing their efforts to use the TMI incident to shut down nuclear power and push the nation into a postindustrial era. We documented the possibility of sabotage at TMI, set up an Independent Commission of Inquiry to look into this, and won the Freedom Foundation George Washington Medal of Honor for a series of articles in *Fusion* on TMI and the antinuclear movement.

At the time, we told the nuclear and utility industries that unless they were ready to launch an aggressive campaign to stop the sabotage of the na-

---

**"To wage an all-out battle for the industrial future of this nation . . . requires naming the names of those who are sabotaging progress."**

---

tion's electric grid system and, thereby, its economy, they would soon find themselves out of business. The response of the nuclear industry was for the most part to be a "nice ostrich"; maybe if we keep our head in the sand, nuclear leaders told us, we'll get by. If we attack the environmentalists and their political backers, they said, it will only anger them and make things worse.

Unfortunately but predictably, this ostrich philosophy failed, and the nuclear industry now finds itself rapidly disappearing. In the process, much of the American public, after several years of unadulterated antinuclear propaganda and nuclear industry apologies, has become almost incapable of making a rational judgment on the nuclear question based on the scientific facts.

Three months after the TMI-2 inci-

dent, the United States had more than 100,000 megawatts of nuclear capacity under construction. During the summer of 1979, the head of the Atomic Industrial Forum, Carl Walske, declared, "Far from being the beginning of the end for nuclear, TMI was really the end of the beginning."

But five years after this new "beginning," 50 nuclear power plants have been canceled or mothballed, and not one new reactor has been ordered. The Washington State Public Power system has gone bankrupt, and other utilities are threatened with fiscal ruin as even completed power plants have been prevented from coming on line.

The Tennessee Valley Authority (TVA), which has the nation's largest power-producing system as well as the largest nuclear construction project, decided at the end of summer 1984 to scrap four unfinished reactors, writing off \$2.7 billion in losses.

Years ago the TVA planned to produce 40 percent of the power for their seven-state system through nuclear energy. But in 1982, the board canceled four units under construction and since then has canceled four more. Now the TVA is left with only two reactors operating and two more nearing completion.

In October 1984, the only remaining market for U.S. nuclear power plants, the export market, began to unravel, as well. President Reagan had promised the industry that China would be spending \$10 to \$20 billion on U.S. reactors. Now the West German press reports that U.S. sales are being frozen by nonproliferation agreements, and West German industry, led by the nuclear firm Kraftwerke Union, may "snare" some of the Chinese business.

If the management of the TMI units decides that for financial reasons they cannot continue to carry the cost of maintaining the operability of the plant without actually producing power, this decision will signal the end of a poorly fought battle for nuclear power in the United States. The option still exists, however, to wage an all-out battle for the industrial future of this nation. As in 1979, it requires naming the names of those who are sabotaging progress and discussing exactly who benefits from surrender.

—Marsha Freeman

# You Can Live to Be 100

## Research on Aging Shows That It's Possible

by John Grauerholz, M.D.

A review of the rapidly expanding area of aging research shows that *within just one decade*, a crash effort to apply already existing knowledge could add up to 30 years to the average human life span. A great number of the people living today might still be around, living productive, healthy lives, 100 years from now.

The premises upon which research in aging are now based are mechanistic; work in the field is based on pushing back mortality rather than defeating it. Notwithstanding, the results achieved so far—with minimal budgets—justify massively increasing these budgets. By pushing life to its seeming limits, we will create the conditions in which fundamental breakthroughs are more likely to occur.

### Immunity and Aging

One area that holds great promise is study of the immune system, which protects the body against foreign organisms and against its own cells when they become cancerous. Studies of people who have lived to 100 or more indicate that their immune systems retain the functioning level of younger people. So there seems to be some definite connection between the immune system and the aging process. Clinically, as an animal ages, certain changes in the immune system accompany, and even precede, symptoms of aging.

For many years it has been known that the thymus gland reaches its maximum size in late adolescence and then progressively shrinks such that the gland has almost disappeared by the mid to late 40s. We now know that the thymus secretes a number of hormones that are crucial for activating certain immune cells involved in defense against infections and cancer. By the age of 60, however, thymus hormone cannot be detected in most humans.



Carlos de Hoyos

*Living to be 100 could be the norm if we accelerate research in promising areas. But if the Malthusians have their way, this man—and others like him who depend on renal dialysis treatments—would die at an earlier age.*

In fact, one branch of the immune cells known as T-lymphocytes or (thymus-dependent) T-cells shows age-related loss of function that can be corrected by administration of thymus-generated hormones. T-cells are the cells that are damaged or destroyed in the tissue of AIDS (autoimmune deficiency syndrome) victims, which leads to infection by rare organisms.

In addition to their direct action against tumors and invading organisms, the presence of T-cells also activates another group of immune cells called B-cells, which are responsible for production of protein antibodies. In aging animals the total production of antibodies is not significantly decreased, but some of the antibodies that are produced attack the body's own tissues, and the remaining antibodies are less effective against both invading organisms and tumors. The situation is analogous to a watchman with failing eyesight who occasionally lets in thieves and shoots the owners.

Many of the changes described in normal aging are produced in so-called

autoimmune diseases in which the body's immune system attacks the body's own tissues. Atherosclerosis, arthritis, and lupus erythematosus are examples of autoimmune diseases in the young that resemble the effects of aging. Investigation of the connections here is a promising avenue of research.

A great deal of animal, and some human, research has demonstrated reversal of immune-system abnormalities by administration of thymus hormones and other substances called immunomodifiers. One of these immunomodifiers, known as interleukin-2, can be produced from human white blood cells, and is already undergoing tests to evaluate its effectiveness against cancer and age-related immune deficiencies.

The human cells used to produce interleukin-2 are abundantly available from blood banks, where they are routinely discarded when whole blood is separated into plasma and red blood cells. The technology is relatively inexpensive and could be rapidly up-

graded to large-scale production. The thymus hormone thymosin is readily available from slaughterhouses and is also synthesized by a number of different processes. Interestingly, a good deal of the research on thymosin therapy appears in the Soviet literature.

#### Theories of Aging

In fact, the question of aging of tissue, taken from the correct epistemological standpoint, will prove to be the key that unlocks all the various disease processes for our understanding and ultimate control. Now, however, most theories of aging treat this entropic process as genetically preordained, either programmed by the DNA like a computer program of decay, or else as a by-product of the random destruction of individual genetic molecular bonds. These theories view the DNA molecule as made up of "building blocks" forming a programmed code in which genes are repeated in sequences, interspersed with so-called nonsense syllables of meaningless material, to form chromosomes.

The current aging theories have two extreme types: those who postulate a totally random accumulation of errors in the form of point mutations, and those who hypothesize a totally programmed reading out of genetic information related to development, maturation, aging, and ultimate life span. Somewhere in the middle is the theory that there is accumulation with age of chromosomal mutations whose lost functions are replaced by redundant (reserve) sequences until the reserves are depleted and senescence ensues.

The actual role of DNA is far more beautiful and complex, acting as an energy transfer focus for cell growth and activities as well as the immune system (see Ned Rosinsky, "The Geometry of Life," *Fusion*, July-Aug. 1984, p. 41). In addition, researchers have now discovered that "old" DNA presumed to be no longer capable of regeneration can be made to function as youthful DNA.

One crucial question of aging that must be answered is whether it is "pre-determined"—is there a clock that ticks only till your time is up? Studies on fibroblasts (cells cloned from animal cells and made to grow in a culture dish) by Dr. Leonard Hayflick indicate that normal cells in culture undergo

only a finite number of cell divisions and then stop dividing (at what is called the "Hayflick limit"). If old nuclei are placed in young cytoplasm, the number of remaining divisions appears to be influenced by the nucleus and not the cytoplasm. These studies are taken to indicate that there is some sort of clock in the nucleus that regulates life span, regardless of other conditions.

Recent experiments, however, have indicated that the Hayflick limit can be exceeded by adding certain factors to the medium. Some researchers, such as Robin Holliday of Britain, contend that there is a population of potentially immortal cells that are simply diluted out by standard culture techniques, leaving only so-called committed cells that have a finite life span.

Is the Hayflick limit merely an experimental artifact, caused by laboratory

techniques and conditions? What connection is there between the simple environment of a culture dish and the complex environment of living tissue within a live organism? What interaction is there between the individual cell nucleus and the hormonal messages within a living body? These are some of the questions that must be answered before one can accept the idea of a rigid clock.

#### Cancer and Aging

The incidence of cancer seems to be related to aging, in that the highest-risk group is aged 45 to 65. There is no truth to the statistics supposedly showing a "cancer epidemic"; the fact is that the population of 45-to-65-year-olds is much greater today than at any time in history, and therefore, people are living long enough for age-related cancers to occur. Past 65, the cancer



Stuart K. Lewis

*The Malthusians want to cut medical costs by reducing the number of elderly.*

## Killing the Elderly and Sick

"If heart disease had been eliminated many years ago, federal programs for the elderly would have cost about \$67 billion more this year alone," opens a press release from the Population Reference Bureau, Sept. 5.

The much publicized report of the bureau, which was enthusiastically greeted by euthanasia supporters such as Colorado Governor Lamm, recommends the elimination of efforts to prevent premature death because of the "excessive cost" to the taxpayer of letting people live. In plain fact, the report recommends the cost-efficiency measures Adolf Hitler implemented when he first began his euthanasia program of gassing the mentally ill and handicapped. "While these remarkable advances mean we can all look forward to longer lives, their impact on society and on the current system of programs for the elderly could be disastrous," the report says.

The solution, according to the Population Reference Bureau, is to start killing the elderly—by slowing down "research directed at eliminating the major diseases and at slowing the aging process."

rate drops dramatically, indicating that if one's immune system is healthy enough to survive to that age, it can handle the occasional cancer cells that are constantly produced in everybody.

Cancer should be viewed as another disease of the immune system, instead of wasting vast sums on identifying carcinogens. Since most carcinogens are natural substances, unavoidable if we want to live in this world, and in fact many carcinogens are produced by the body itself, it would be better to develop ways to cure flagging immune systems so that they can recognize and destroy cancer cells or the tumors they give rise to.

One interesting line of research is that of Dr. Takashi Makinodan of the National Institute on Aging, who suggests that decreasing caloric intake accompanied by vitamin and other supplements or injecting immune cells from younger donors may prove a cure for cancer as well as aging. Presumably the reduction of caloric intake slows the maturation rate of the immune system. This presents certain problems early in life; however, if these are weathered, it extends the maximum (as opposed to the average) life span.

On a more fundamental level, recent breakthroughs in molecular biology and neurochemistry are beginning to reveal intimate interactions between the brain and the immune and endocrine systems. These connections have been especially well delineated in the study of the hypothalamus, an area at the base of the brain that is connected to the pituitary gland, the "master gland." Immune function is also affected by pituitary hormones and, in addition, it has been demonstrated that T-cells have surface receptors for the neurotransmitters responsible for cell-to-cell communication in the brain.

Among the more exciting developments in the area of brain research is the recent report that new neurons (nerve cells) are formed in adulthood in canaries in association with learning. These cells arise from a population of undifferentiated nerve cells that form a reservoir of potential new cells to replace lost or damaged cells. The implications of growth of new neurons in response to learning may have great relevance to the problems of brain in-

jury and aging. This may explain why staying mentally active, learning and teaching, seems to play a function in avoiding senility.

On another front there is evidence from both animal and human studies of benefits of transplantation of cells into the brain. The cells derived from the adrenal gland produce neurotransmitter chemicals that are lacking in such disorders as Parkinson's disease. At a recent conference, researchers from the Karolinska Institute in Stockholm described two such transplants in humans conducted in 1982 and 1983.

#### The 'Garbage Glut' Theory of Aging

The finite-multiplication characteristic (Hayflick limit) of normal cells in culture does not apply to transformed (malignant or cancerous) cells, which will divide infinitely as long as they are fed. In the process of transformation, whatever factor is responsible for stopping replication in normal cells is lost. When a normal old (nondividing) cell is fused with a transformed cell, the nucleus of the old cell will synthesize new DNA. This indicates that the DNA of the old cell may *not* be irreversibly altered by age.

Free-radical damage to proteins and lipids has also been described as a possible mechanism for wear-and-tear aging; that is, the small slings and arrows of time may accumulate over the years to create a gross, "garbage glut" effect, clogging the cell. Free radicals are highly reactive substances such as peroxides that combine with anything that happens to be in their vicinity to oxidize it. Evidence for this is the golden-yellow pigment lipofuscin that accumulates in certain aging cells, which is a waste product of membrane lipid peroxidation by free radicals.

Dr. Denham Harman has shown an increase in average life span up to 50 percent in some animals by supplementing their diets with free-radical scavengers such as BHT (bis-hydroxytoluene), which apparently prevent or slow down damage. Further evidence is supplied by the fact that superoxide dismutase, one of the naturally occurring antioxidants, is responsible for protection of mitochondria, the small bacterial-like structures within the cell that are involved in energy metabolism.

Another readily available substance that has shown promise in delaying the aging process is a naturally occurring hormone known as DHEA (dehydroepiandrosterone). This substance apparently helps maintain the structure of DNA and suppresses enzymes that activate carcinogens. It is currently being evaluated in animal studies, and initial results are quite promising. DHEA is elevated in fasting animals and may account for the prolongation of life span observed in calorically restricted animals.

#### A New Approach Needed

At present, scientists are in a position to begin to apply some of the particular facts obtained from aging research, in order to extend the average human life span. Yet, we are in need of a coherent theory of aging that will incorporate all of these various data with a better understanding of the regentropic life process itself. There are mountains of data that describe aging changes at various levels, molecular, cellular, tissue, organ, organ system, and organismic, but there is no proper epistemological standpoint.

The most coherent of the current theories indicate conformational changes in the cellular DNA and its associated proteins, which affect primarily the neuroendocrine and immune systems that are in one way or another responsible for communication and learning within the organism. Disordered function of these systems then produces the spectrum of physical changes subsumed under the heading of aging.

In spite of the inherent theoretical limitations of viewing life in terms of nonliving chemistry and physics, a great deal of information on the aging process, and means of altering it, already exists. With a crash program we could no doubt increase the average life span by 30 percent within the next decade. Equally as important, we could postpone the debilitating effects of aging to ensure the "elderly" the potential for an active and effective life.

The real obstacle to life extension in the near future is not scientific or technical, but the neo-Malthusian political philosophy that views life-extension, and indeed, some human life itself, as an excessively costly burden to society that just might have to be triaged.

# Japan's Gekko XII Laser Scores Major Advances in Inertial Fusion

Major advances in the Japanese inertial confinement fusion program, achieved with the world's most powerful laboratory laser, the Gekko XII, were announced by Dr. Chiyo Yamanaka at the 10th International Conference on Plasma Physics and Controlled Nuclear Fusion Research held in London Sept. 12-19. Japan may now have leapfrogged the United States in this important technology, although this is impossible to judge since U.S. research in this area is top secret and there is no official cooperation with Japan on inertial fusion.

Yamanaka heads the Institute for Laser Engineering at the University of Osaka, the world's most powerful and versatile inertial confinement fusion laser facility, which houses the 12-beam, 30-kilojoule, 50-terawatt Gekko XII glass laser. At the conference, Yamanaka reported that Gekko XII was able to generate more than 40 billion fusion neutrons. Since one of the primary products of the fusion reaction is neutrons, this provides a direct measure of the number of reactions achieved; 40 billion is essentially equivalent to the best result previously attained with the U.S. Shiva laser at Lawrence Livermore National Laboratory.

(Because of funding cuts, Livermore's Nova laser system, the successor to the Shiva, will not begin experiments until 1985.)

More significant, fuel compressions more than 100 times the normal liquid density of hydrogen were achieved. Since density is the key to high gain, this result is even more important than the amount of fusion achieved and, again, is equivalent to the best results achieved by the U.S. program.

Yamanaka also reported new experimental results that promise greatly to enhance the efficiency and effectiveness of indirect-drive targets—results that open up entirely new possibilities



Steven Bardwell

*The beam system for the Gekko 2M laser in Osaka, a predecessor of Gekko XII.*

for inertial confinement. In indirect-drive inertial confinement, the incident laser beam energy is transformed into another form, usually X-rays, that is then used to compress and heat the fusion fuel target. Indirect-drive research is under top security wraps in the United States.

## The Osaka Cannonball

The Osaka cannonball target surrounds a direct-drive target with a hollow metal sphere. (In direct-drive inertial confinement, the laser beams are symmetrically directed onto the target's surface, which ablates, creating a

inertial force directed toward the center of the fuel.) The metal sphere has holes in it so that laser beams can be directed onto the interior surface of the sphere. Plasma generated by the laser irradiation of this interior surface quickly moves across these openings and thus traps the laser beams within the sphere.

There are two possible configurations in the cannonball target.

First, in a *plasma cannonball*, the fuel pellet surface is close to the interior surface of the metal sphere. The plasma generated by the laser irradiation of the interior of the metal sphere will come into contact with the fuel target and compress it just as the hot gases trapped in a gun barrel propel a cannonball (Figure 1).

Second, in an *X-ray cannonball*, the fuel pellet radius is significantly smaller than that of the metal sphere, and therefore the two surfaces are geometrically separated. In this case only soft X-rays from the plasma created on the interior of the metal sphere will make contact with the fuel pellet.

It has been known theoretically for some time that X-rays generated by a laser-produced plasma offer the best means of achieving uniform and efficient high-density compression of fusion fuel. This is because the energy of the individual laser beams has been uniformly spread out in the plasma generated over the interior of the metal sphere. Therefore, the resulting X-ray radiation is quite uniform when it falls onto the fuel pellet.

Also, it has long been known that X-rays have the ideal wavelength for coupling electromagnetic radiation to solid matter. This means that the X-rays will be most efficient in driving the implosion of the fusion fuel target.

Experiments demonstrated that fairly high implosion efficiencies in the range of 5 to 6 percent were achieved with both the plasma and X-ray can-

nonball targets. Implosion efficiency is a measure of that part of the incident laser energy that goes into compressing the fuel. As seen in Figure 2, the

cannonball targets achieved a higher absorption of incident laser energy at higher laser intensities than did direct-drive targets.

**Figure 1**  
**LASER FUSION TARGET CONFIGURATIONS**

A direct-drive target is shown in (a), where the cones represent incident laser beams. In direct-drive fusion, the beams are symmetrically directed onto the surface of the sphere of fusion fuel. As the beam energy is deposited, the surface of the fuel target is boiled off, a process called ablation. Like a rocket exhaust, ablation creates an oppositely directed force toward the center of the fuel target, compressing the fuel to high densities. The fuel will now burn up before it blows up; that is, the small ignited core will generate sufficient fusion energy to heat and burn the remaining fusion fuel.

Two different geometries for cannonball targets are shown in (b). Here the incident laser beam cones are trapped within the cannonball. In this indirect-drive method, the incident beam energy is transformed into another form of energy, usually X-rays, that then compresses and heats the fusion fuel target.

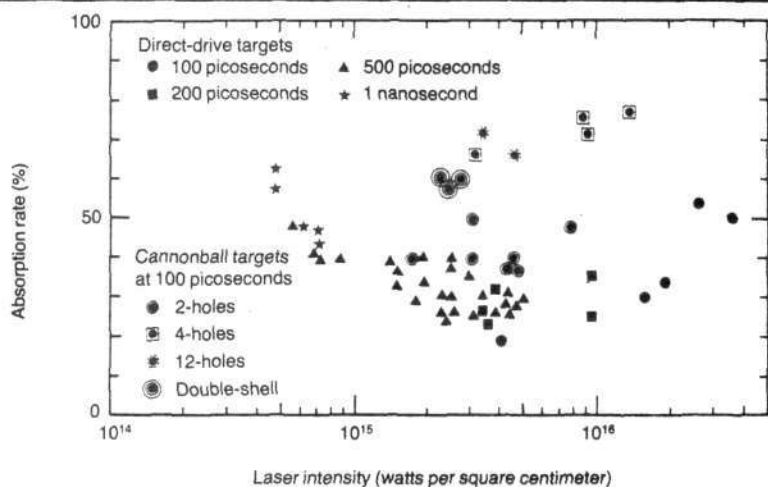
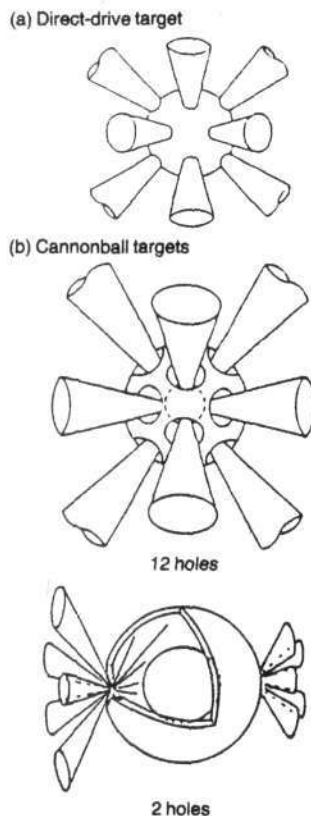

**Figure 2**  
**ABSORPTION RATE OF VARIOUS LASER TARGETS**

The various types of cannonball targets achieved higher absorption of incident laser energy at higher laser intensities than did direct-drive targets. The experimentally measured absorption rate of incident laser energy is given in percentages; incident laser beam intensities are given in watts per square centimeter.

### Tuning into the Target

In addition to successfully demonstrating the essential features of both plasma and X-ray cannonballs, the Osaka group discovered a new possibility that could significantly decrease the requirements for high-gain inertial confinement fusion. First, the Osaka group reported that in the laser generation of X-rays, the resulting X-rays can be tuned to specific wavelengths by choosing different materials for the interior of the metal cannonball. These "tuned" X-rays are often called *line radiation*.

Second, the fuel target can be made so that its surface consists of layers, each of a different material. The layers can be arranged so that X-rays of one wavelength will readily penetrate some layers and deposit their energy on an interior surface of another layer.

By generating several different X-ray line radiation wavelengths and using a number of material layers on the fuel target, the deposition of the total X-ray energy can lead to the simultaneous generation of several compression shocks on the interior of the pellet. This can lead to the tuning of the compression process to achieve the most efficient densification of the fuel.

This same type of tuned X-ray deposition can also be used to achieve an increase in the effective power density of the incident X-rays. The fuel target surface layers can be further modified such that in deposition of the line X-rays, their energy is transformed into soft X-rays (often called blackbody radiation), which are trapped between two surface layers.

Because the layers are imploding on one another, this trapped blackbody radiation will be driven to higher power densities. The theoretical papers of the Osaka group indicate that this type of X-ray power amplification can reduce the initial beam requirements for inertial confinement fusion by more than one order of magnitude.

As these processes are further explored experimentally and theoretically they could lead to a major decrease in the projected costs of inertial confinement fusion power and to entirely new, energy-dense plasma regimes that will further advance the horizons of fundamental science.

—Charles B. Stevens

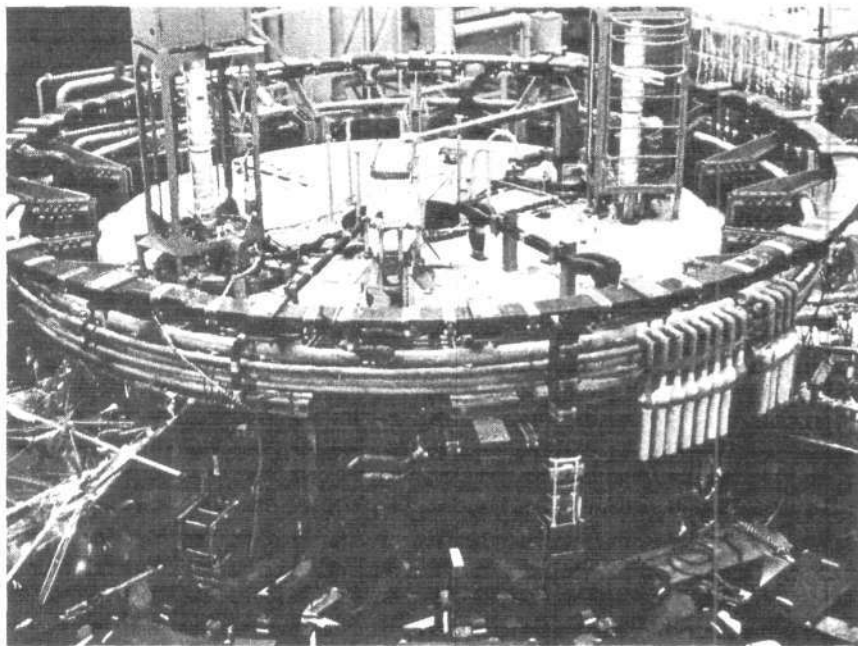

Fusion Asia

## Kyoto's Heliotron: A Unique Fusion Machine With Great Promise

*The author, Fusion Asia editor-in-chief Ramtanu Maitra, toured the Plasma Physics Laboratory at Kyoto University during a trip to Japan in February 1984. This article is adapted from his special report on the Japanese fusion program in the July 1984 issue of Fusion Asia.*

Heliotron E, the latest in a series of unique magnetic-confinement fusion machines, has made steady progress toward attainment of breakeven conditions with relatively high confinement time, and its results rank with all the mainline experiments. The device is located at the Plasma Physics Laboratory at Kyoto University, where Professor Koji Uo has been conducting heliotron fusion research for the last 26 years.

Although it is a promising alternative route to magnetic-confinement fusion, the heliotron has progressed in relative obscurity, with more attention paid to it in the United States than in Japan.

The heliotron is a high- $\beta$ , steady heli-

ical system that produces a currentless plasma, using the toroidal field coils to regulate field properties rather than to confine the plasma. The only other large device for helical systems at present is the Wendelstein VIIA in West Germany.

Trained as an electrical engineer, Uo developed the heliotron concept from his understanding of electromagnetic fields, and he has continued to maintain hands-on involvement in every aspect of its development.

The idea is elegant in its simplicity and in the extent to which it takes advantage of the natural behavior of the plasma. Uo built the first heliotron—Heliotron A—in 1958, and the second—Heliotron B—a year later. A new and improved model has been built every five years since then. The present generation is called Heliotron E.

The heliotron project, financed by the Ministry of Education, Science, and Culture, rather than the Japan Atomic Energy Research Institute (JAERI), employs 19 physicists. It also has significant help from private corporations

*Heliotron E, the latest in a series of heliotron machines designed by Professor Koji Uo at Kyoto University, has registered relatively high confinement time.*

such as Hitachi, Mitsubishi, and Toshiba. Uo feels that the apparent official indifference to his work will change. "The heliotron will do it [produce commercial fusion power] before the tokamak does," he said.

### The Heliotron Concept

There are two different ways to confine a high-temperature plasma with magnetic fields to produce controlled fusion energy. In the first, the magnetic pressure is comparable to the plasma pressure, as in a pinch-type machine. In mirrors, tokamaks, and heliotrons, however, the magnetic pressure is much greater than the plasma pressure.

The heliotron has a donut-shaped vacuum chamber similar to the tokamak, but the heliotron's magnetic field is entirely different. Where the tokamak has toroidal coils, shaping coils, joule heating coils, plasma heating coils, and divertor coils, the heliotron possesses only helical, vertical, and toroidal field coils.

A currentless steady-state operation is the basic design concept of the heliotron series. (That is, there are no currents within the plasma itself, although an electric current must be used to produce the magnetic field.) Uo's experiments have clearly demonstrated two noteworthy features of the heliotron: first, the heliotron plasma remains extremely stable; and, second, the level of impurities is remarkably low, a fact that, in turn, confirms the efficiency of the plasma containment.

Moreover, the plasma is so stable that it is not disturbed by infusion of even small amounts of impurities at the plasma center. What the impurities do, however, as Uo explained, is restrict the rise of plasma temperature. To deal with this problem he has conceived a "secret design" to keep the plasma completely clean, and he will incorporate this design in the next model, Heliotron ES, which is now on the drawing boards.

Uo has also worked out the parameters of a commercial heliotron, Heli-

otron H, and expects this to be built by the year 2000.

#### First-Generation Heliotrons

Heliotrons A and B, the first generation, were simple: The magnetic field was produced by the electric current in a series of pair coils wound around the discharge tube at regular intervals. The electric current in each coil of the pair differed both in intensity and direction. The lines of force in this field were undulated near the tube axis without cutting the wall, while those near the tube wall crossed the wall. Thus the high-temperature plasma could be produced by ohmic heating in the central region of this field and be prevented from touching the wall.

In fact, the plasma current was observed to flow only within the central region, whose mean cross-sectional diameter was about 3 centimeters, and the plasma had a sharp boundary. Outside of this region there was no

current. From the experimental results, it became evident that the hot plasma was almost perfectly isolated from the stainless steel tube wall by the heliotron's magnetic field.

Heliotron B, made of stainless steel, had the shape of a race track. The stainless steel tube's skin thickness of 2 millimeters was insulated by a ceramic tube at one of the two linear legs. Nine apertures for diagnostics were located in the tube.

The negative and positive coils that produced the Heliotron B magnetic field were contained in gun metal cases fixed on the iron trusses supporting the tube. The primary winding, which induced the accelerating field for the ohmic heating, was wound on the outside of the gun metal cases, parallel to the tube axis. An 84-kilojoule-maximum-energy capacitor was the energy source for the field coils and ohmic heating winding.

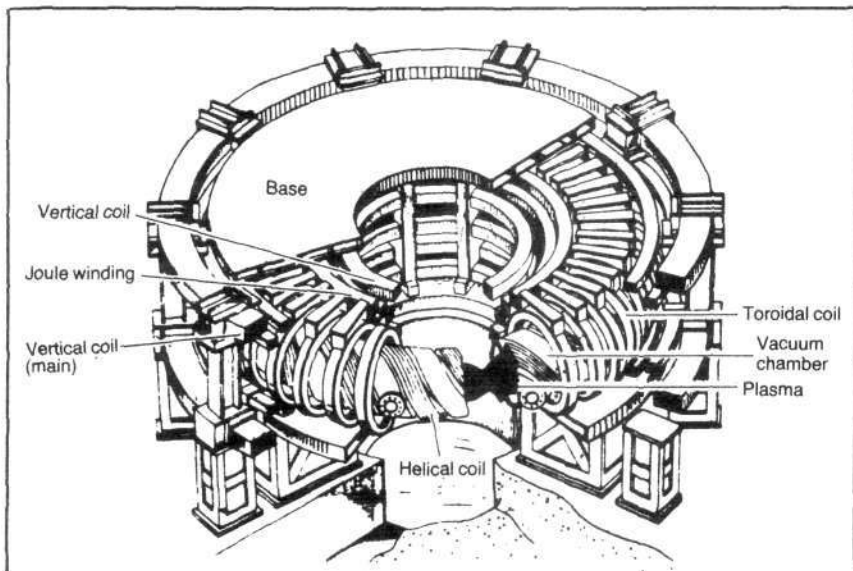

**SCHEMATIC OF THE HELIOTRON E**

The Heliotron E has a donut-shaped vacuum chamber similar to the tokamak, but the heliotron has only helical, vertical, and toroidal field coils. The confining magnetic field is produced by a combination of these coils.

The helical conductor, mounted outside the vacuum chamber, closes itself after 2 toroidal and 19 poloidal rotations. An opposing vertical field is necessary to cancel the vertical field produced by the helical coil. The toroidal field coils are not needed to produce the confining field, but are used to change such field properties as rotational transform, shear, and volume of the confining region. The electrical power is fed to the coils by a 330-million-volt-amperes AC generator through rectifiers.

The Heliotron E produces a currentless steady-state plasma of high stability and with a low impurity level.

It was observed in Heliotron B, however, that the confining conditions seemed rather strict, and therefore particles were lost from the circular-cusp series. Thus, after experimenting with Heliotron C (a circular machine), Heliotron D was built to overcome these faults by making the coils helical around the tube. The field thus became similar to the field produced by the helical windings in a stellarator, but in Heliotron D the pitch of the windings was made shorter and the helical winding carried only unidirectional current.

Heliotron E, the present generation, has a major radius of 2.2 meters and a minor radius of 0.2 meter. The toroidal magnetic field is 1.0 tesla. The machine uses electron-cyclotron resonance heating to produce and heat plasmas. It is also equipped with a neutral beam injection system that has three beam lines, each with two injectors of a magnetic multicusp type. Two beam lines are deliberately arranged at 28 degrees off the normal injection angle and one in the perpendicular injection angle of the torus in order to investigate the influence of injection angles. By May 1984, the neutral beam system was expected to provide 4 megawatts at maximum beam energy; the resonance heating system will use about 1 megawatt heating power.

#### Present Results

In resonance heating, the torus is filled with hydrogen gas 500 milliseconds (msec) before the radiofrequency (RF) pulse. During the pulse, additional gas is put in to keep the density constant. The plasma is considered to be fully ionized 2 msec after the beginning of the RF pulse. The central electron temperature continues to rise to 1.0 kiloelectron volt (keV) at 20 msec, after which it seems to saturate during the RF pulse. The central ion temperature is much less, 0.11 keV at 20 msec.

The ion temperature saturation phenomenon,  $U_0$  stressed, may be caused by the charge-exchange loss. A new set of experiments has been carried out replacing hydrogen gas with helium gas. Since the charge-exchange cross section of helium plasma is much smaller than that of hydrogen plasma, the temperature attained was higher.

—Ramtanu Maitra



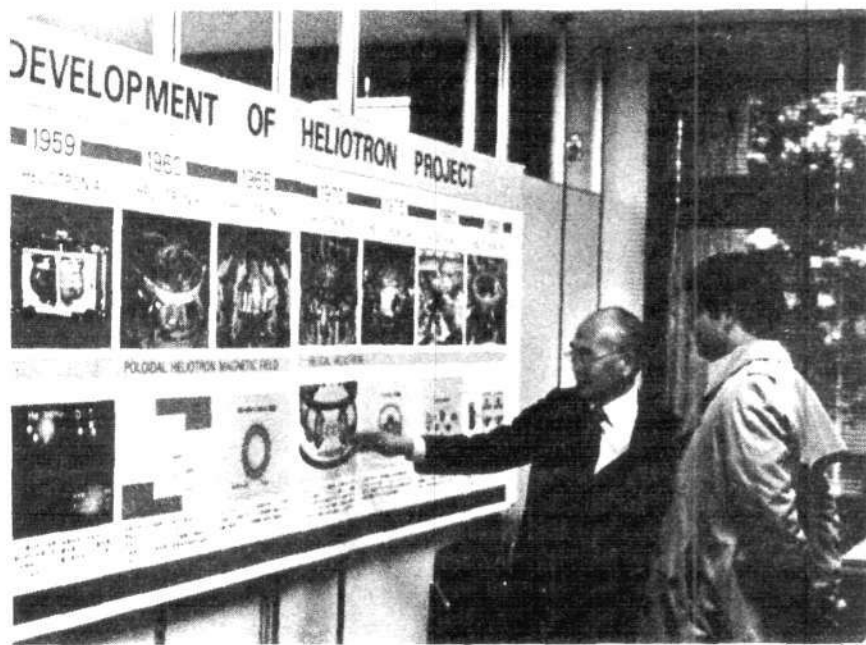

Fusion Asia

Professor Koji Uo showing the history of the heliotron design concept to Fusion Asia editor Ramtanu Maitra (right).

## 'A Prototype Reactor by 1999'

Professor Koji Uo spoke with Heinz Horeis, managing editor of the German-language *Fusion*, at the 11th European Conference on Controlled Fusion and Plasma Physics in Aachen, West Germany. Here is an excerpt from that interview.

"Many people say that the realization of fusion will take 50 or 70 more years, until the middle of the next century. In our country there are some people who have this opinion, too, but most do not think this way. I believe if, for example, our present experiment is successful, we can realize a reactor in this century—if we get the necessary funding. Then we can proceed very quickly.

"In Kyoto we are working now with the Heliotron E machine—a high-beta, steady, helical and currentless system. If it is successful, we could have a prototype power reactor, the Heliotron G, with 1,000 megawatts around the year 1999. . . .

"Japan conducts almost all the alternative lines to the tokamak, including the compact tori, the plasma pinch, the plasma focus, and the spheromak. . . . The philosophy behind this approach is that our projects are sep-

arated in two parts. JAERI [a government institute] is more or less following the safe way—mainly the tokamak, because most of the world is focusing on this principle. JAERI is now building the JT-60, which will be completed in 1985.

"The universities, on the other hand, belong to the Ministry of Education, Science and Culture. Their research is very free. The Ministry of Education does not order, 'You have to do this or that.' If a university has a good idea, a project with good prospects, then it will get the funding for it. . . .

"Japanese industry is deeply involved in fusion research because . . . in our universities the manpower is very poor, and we have no or very small machine shops. So everything, beginning with the small-sized machines, we order from industry. We do the design and the supervising of the construction.

"This gives our industry a great advantage in being involved in the creation of new technologies from the very beginning. Now the machines worldwide are very large and no university or laboratory machine shop could build them. So we already have the industry with the necessary knowhow."

# EIR

was right  
about the 1980s  
depression.

**All the other  
forecasters  
were  
dead wrong.**

For thirteen quarters since 1979, Executive Intelligence Review has published summaries of the LaRouche-Riemann model's quarterly forecast of the U.S. economy. We warned that if Paul Volcker's high-interest rate policies continued, the U.S. economy would slide through two dips into the worst world depression in modern history.

Every other econometric forecast, government and private, predicted an "upturn."

EIR was consistently right; the Brand X forecasters were consistently absurd.

That's the standpoint from which our independent worldwide intelligence gathering network works. And that's why we have been right about a lot of things where all the media have been wrong.

## EIR

3 months . . . . . \$125

6 months . . . . . 225

1 year . . . . . 396

- Please send me a brochure on EIR.  
 I would like to be contacted by a sales representative.

\_\_\_\_\_  
Name

\_\_\_\_\_  
Company

\_\_\_\_\_  
Address

\_\_\_\_\_  
State/Zip

\_\_\_\_\_  
Telephone

Executive Intelligence Review, 304 W. 58th St., 5th Floor, New York, N.Y. 10019. For more information call (212) 247-8820; in Washington, (202) 223-8300.

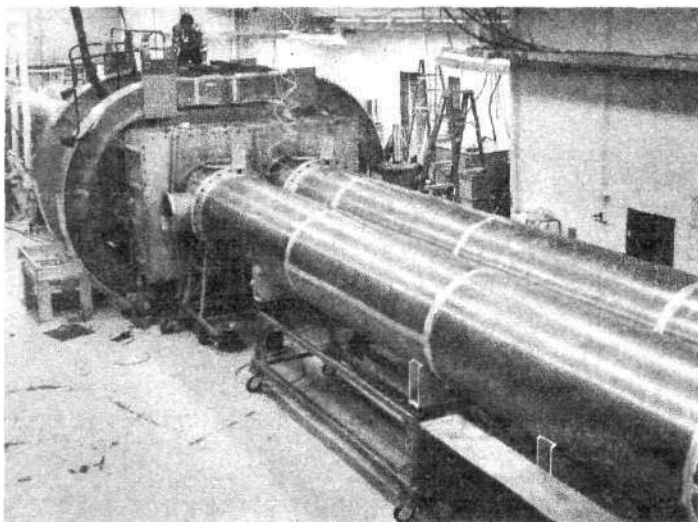
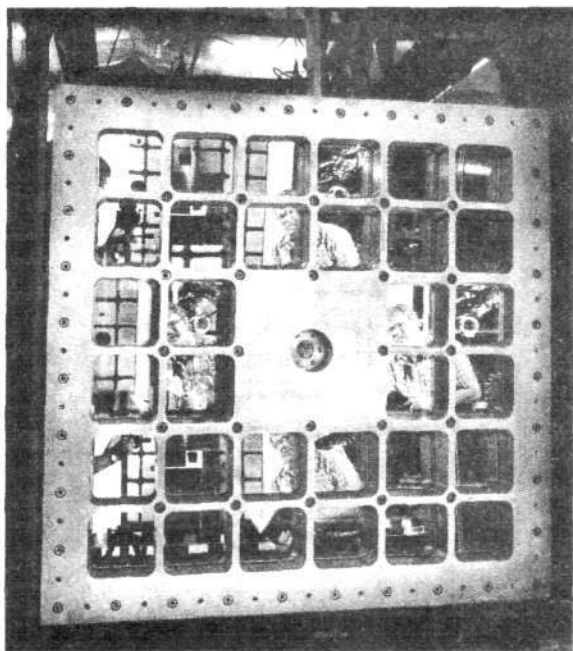

Photos by Fred Rick/Los Alamos National Laboratory

Left: Quartz mirrors reflect multiple images of researcher George York as he checks the paper target that successfully documented Aurora's pinpoint accuracy. Above: The krypton fluoride laser at Los Alamos.

## Krypton Fluoride Laser Fired: 'New Dawn for Fusion Research'

Aurora, the krypton fluoride gas laser at Los Alamos National Laboratory in New Mexico, was successfully fired July 3, making it one of the most promising candidates for practical laser fusion electric power reactors. Los Alamos titled its news release on the event, "Aurora: New Dawn for Fusion Research?"

The krypton fluoride laser is also a primary candidate for a defensive beam weapon that can destroy nuclear-tipped missiles in their vulnerable boost phase.

Aurora takes us much closer to a fusion reactor because it meets the exacting specifications needed for practical laser fusion energy production. According to Louis Rosocha, manager for the Aurora project: "It has a short wavelength for efficient coupling of laser energy to fuel targets, the capability of being cost-effectively scaled to a large size, the ability to fire repeatedly, and a tremendous, economical efficiency in comparison with other lasers—a possible 10 percent efficiency . . . or more than five times that of some systems."

These same qualities—coupling of laser energy to targets, economic scaling to higher energies, high repetition

rates (tens to thousands of shots per second), and high laser beam generation efficiency (10 percent)—also make the krypton fluoride laser an effective system against nuclear-tipped missiles.

### Near-Term Developments

The July 3 test achieved a 3,000-joule laser pulse generated within 400 billionths of a second. Los Alamos experimenters plan soon to bring this total energy up to 10,000 joules in the same pulse length.

Experiments using angular multiplexing to compress the pulse length to 5 billionths of a second—increasing the beam energy flux density by a factor of 80—will also be carried out in the near term. Angular multiplexing is a form of optical compression in which the light pulse is cut up into many parts and spatially stacked to form a more compact and powerful pulse.

The Aurora laser module is the prototype for a full-scale multimodule laser needed for both fusion and beam-weapon applications. Los Alamos reports that a prototype multimodule system, the Polaris, is under design now, which would be only one stage removed from the million-joule energy levels needed for deployable sys-

tems for fusion energy production and for beam defense.

"So impressive is the new system, the 50,000-joule laser called Polaris may be underway as early as mid-fiscal-year 1986," the lab said. Polaris can be realized this quickly because it can make use of the existing structures of Los Alamos's long-wavelength carbon dioxide laser, Antares.

### The KrF Laser and the X-Ray Laser

When combined with the nuclear-bomb-pumped X-ray laser, the KrF laser provides the overall capability for making offensive nuclear missiles obsolete. The X-ray laser is the most lethal beam weapon yet demonstrated. Each X-ray laser system popped up into space when a large-scale missile attack is detected could destroy scores of ICBMs as they rise out of the atmosphere.

But the X-ray laser must kill above the Earth's atmosphere (about 70 kilometers altitude), because dense air absorbs X-rays and prevents the propagation of the X-ray laser beams. In this regard, the krypton fluoride laser provides a major complement to the X-ray laser. The krypton fluoride laser beam is capable of penetrating well below the 70-kilometer altitude limit of the X-ray laser, killing missiles within the atmosphere and in their boost phase.

In fact, the krypton fluoride gas laser represents the most effective laser for achieving this complementary capability to the X-ray laser, because it has

just about the shortest wavelength with which optical transmission can be achieved. At the even shorter wavelength of X-rays, all existing types of materials used in optical systems, such as mirrors and lenses, are destroyed by the electromagnetic waves. The 0.248-micron wavelength of the krypton fluoride laser represents the current minimum for which such materials can still be utilized.

#### **Wavelength and Lethality**

Both in terms of propagation range and coupling of laser energy to a target, wavelength is an essential parameter. Laser beam divergence is directly proportional to wavelength. Therefore, given laser beam pulses of equal energy and utilizing the same size mirrors, the 0.248-micron krypton fluoride laser would have a lethal range 10 times that of the 2.7-micron chemical laser.

In terms of coupling, the advantage of shorter wavelengths becomes most evident. For the longer-wavelength chemical lasers, upwards of several thousand joules per square centimeter may be needed; the krypton fluoride laser can achieve the same result with just a fraction of the energy flux density. The krypton fluoride laser and X-ray laser pulses achieve kills by shock-induced damage, while longer-wavelength lasers depend on burning holes through their targets.

At the krypton fluoride wavelength, the laser light is deposited right on the target's surface. At longer wavelengths the energy is deposited instead in the low-density plasma generated during the laser light irradiation of the target. The result is that the energy in the latter case is deposited over a larger volume, therefore generating a smaller pressure buildup per unit energy. This difference between the short and long-wavelength coupling is analogous to the difference between trying to drive a nail or a hammer through a piece of wood.

#### **Deployment and Future**

Although the X-ray laser unit itself, because of its small size, would be popped up into space on a small rocket for boost-phase intercept, the krypton fluoride laser would most likely be deployed either on mountaintops or large aircraft. The krypton fluoride laser beam would then be transmitted via

*Continued on page 18*

## **Los Alamos Begins Work On Gamma-Ray Laser**

Scientists at Los Alamos National Laboratory have launched a major research project "that could result in the world's first nuclear laser in just a few years," the lab announced Sept. 21. A research team headed by Dr. George Baldwin has studied this idea of a gamma-ray laser (or "graser") for 20 years and now feels confident in going ahead with the next step: actual experiments to discover what material will be a good graser substance.

"Grasers offer enormous scientific potential," said Baldwin. "In the 1960s they looked utterly impossible to make. Now I think it can be done and in just a few years." Achieving the graser, however, will be "as difficult a challenge as any ever undertaken," according to Baldwin.

Most graser research has been carried out in the Soviet Union over the past several decades. Now the United States will try to catch up with experiments designed to discover whether the extreme conditions needed to attain gamma-ray lasing can be practically realized.

#### **Gamma-Ray Lasing**

Unlike ordinary lasers, which utilize electron energy levels (characteristic of chemical reactions), the graser almost certainly must be based on nuclear-level transitions.

Baldwin's team will explore candidates for the host material with the help of the Los Alamos atom smasher accelerator. The sought-after host substance must be able to absorb a precise amount of energy in the nucleus from an external source, store the captured energy while remaining in an excited state, and release this extra energy as gamma-rays and not as other kinds of radiation.

The Los Alamos team will try to find out if there are ways of producing the desired nuclear transitions and maintaining them until a sufficient amount of such "excited" material has been concentrated in order to produce the macroscopic conditions for grasing.

For generating the desired nuclear transitions, the Los Alamos team has been exploring the possibilities of a

two-stage process. Nuclei are first irradiated with neutrons and brought up to a certain energy level. Then when they are assembled in a concentrated form, they are irradiated with a laser pulse. This pulse changes the electron configuration of the atom and is found in some cases to effect a transition in the nucleus.

Through this means it is hoped to find a way to transform quickly a long-lived nuclear excited energy state into a short-lived one capable of lasing.

A second type of experiment being carried out is that of using lasers for rapidly separating excited nuclei from unexcited ones. In this way the excited nuclei can be concentrated quickly in a sufficient dense quantity to support grasing.

The graser will have importance in military defense as part of an antiballistic beam defense, because it will fire highly energetic pulses of penetrating radiation in repeatable and accurate beams that can easily pass through the atmosphere. In fact, the graser will have all the advantages of the X-ray laser, only more so, because of its shorter wavelength and higher frequency.

Electromagnetic radiation ranges over a spectrum of wavelengths and characteristic energies of action, with wavelength and frequency being directly inverse. The longest wavelengths are those of radiowaves, which also have the smallest characteristic energy of action. X-rays have far shorter wavelengths and are far more energetic and penetrating. Visible light waves, which are the energy form in lasers, fall in between, and gamma-rays have the shortest wavelengths and highest characteristic energies of action.

The distinction between gamma-rays and longer-wavelength ranges of the electromagnetic spectrum is like that between chemical and nuclear reactions. In fact, light waves and X-rays are generally capable of directly inducing only chemical types of transformations in matter, whereas gamma-rays are capable of producing nuclear reactions.

This is because of the respective wavelengths. Imagine a grid with slits through which the light or ray must pass, where the size of the slits controls what wavelengths or "widths" of rays can pass through. On the atomic scale, such "slits" are on the order of  $10^{-10}$  meter (or 1 angstrom) for the atomic radius, including the electron energy levels where chemical reactions are controlled. Thus visible light with wavelengths on the order of  $10^{-7}$  meter can affect only the outer shells of atoms while X-rays with wavelengths on the order of  $10^{-9}$  to  $10^{-12}$  meter can actually penetrate the atoms.

To interact with the atom's nucleus, however, requires wavelengths commensurable with its radius of about  $10^{-13}$  meter. Only gamma-rays have small enough wavelengths (down to  $10^{-20}$  meter) to reach and interact with nuclei.

#### Grasers for Beam Defense

Gamma-rays are in fact the most penetrating form of radiation, and pass easily through the atmosphere without deflection or loss of energy. This offers great possibilities for a system of defensive beam weapons to shoot down attacking nuclear missiles. One advantage of the graser over that of the X-ray laser is that it could penetrate more deeply into the atmosphere. This would mean that even fast-burn rocket boosters could not escape destruction. Moreover, when "tuned" to the appropriate wavelength, gamma-rays will react vigorously with atomic nuclei.

Because of these characteristics, graser beams would be the most efficient and effective beam weapons. They could be tuned to efficiently propagate through the air and other material barriers. At the same time they would react vigorously with "heavy" nuclei like the uranium and plutonium fuel used in nuclear weapons. Because the incident gamma-rays would generate nuclear reactions, only a minute energy deposition would effectively denature a nuclear weapon, turning it into a dud. In other words, with an energy equivalent to the tap of a human fist, the graser beam could kill offensive nuclear warheads.

In terms of range, the short-wavelength graser has the potential of attaining destruction of nuclear war-

heads over gigantic distances—millions of miles. In fact, just as the X-ray laser will be vastly superior to the first-generation chemical lasers that should be on-line now, so the graser will supersede the X-ray laser for beam defense.

#### A Revolution for Science

Lasers produce coherent beams of radiation—electromagnetic waves in phase and all at the same wavelength. This means that the radiation they generate can be focused to extremely high power densities. Since gamma-rays can cause nuclear reactions without being focused, a focused graser beam would provide the means of attaining super-nuclear energy densities, a unique state of matter providing the conditions for all sorts of experiments addressing fundamental problems in physics, such as the birth of the universe.

Having a coherent source of electromagnetic radiation also makes three-dimensional pictures—holograms—possible. The wavelength of the coherent radiation determines the resolution with which the three-dimensional picture of an object can be made. Holograms made with light lasers, whose resolution is only in the range of one-millionth of a meter, are already used in industry.

For example, a hologram of a piece of machinery can be superimposed on the actual machine. As the machinery is brought into operation its physical shape becomes distorted by strain and stress. These distortions will cause visibly apparent interference patterns with the superimposed hologram image. In this way the actual stresses can be seen on a microscopic scale.

Experiments are already being carried out to use coherent X-rays from X-ray lasers and synchrotron radiation facilities to produce X-ray microholograms. The much shorter wavelength of X-rays makes possible the imaging of individual molecules. Most significant, the shorter-wavelength radiation also makes possible much smaller temporal resolutions.

The net result is that it is possible to achieve something like a moving picture of the molecules of living matter. Because of the even shorter wavelength of grasers, this type of microholography of living cells can be greatly extended in both resolution and the types of objects that can be imaged.

Thus, as a diagnostic tool, grasers will provide a unique way of dissecting the nucleus and atom and become a potentially powerful microscope that could actually examine individual cells and their structure in unprecedented detail. The most exciting aspect of this is not merely the possibility of viewing molecules of DNA in detail, but the fact that such molecules will be living and in action while viewed.

For the first time, man will be able to observe directly the structures and chemistry responsible for life itself. Cancer and aging research, as well as all aspects of disease and health care, will be revolutionized overnight. Genetic bioengineering will become a fully elaborated science. The potential impact is so great scientifically that the comparison to the discovery of the telescope falls far short; it is like the invention of the eye. Graser microholography promises to revolutionize all medical and biological research.

This is best seen in the case of nuclear spectroscopy. For over a century spectroscopy with electromagnetic radiation in the light range has been used to unravel the chemical dynamics of matter. In other words, this type of spectroscopy is used to "see" the electron structure of atoms in molecules. Grasers will extend this capability to the nucleus itself. Besides vastly improving the possibilities of extending our fundamental understanding of nuclear processes, graser nuclear spectroscopy will open up entirely new forms of nuclear energy.

—Charles B. Stevens

## Krypton Fluoride Laser

*Continued from page 17*

orbiting mirrors to be directed to the target. These mirrors would be of two types—some orbiting during peacetime and others popped up when an attack is detected. Each krypton fluoride laser could generate tens to hundreds of lethal shots per second.

Once the Polaris system is realized, deployment would only be a question of engineering resources. Given the recent Los Alamos developments there appears to be no reason that such deployed systems could not be attained within five years if there is a crash effort to get the job done.

—Charles B. Stevens



*Everything you need to know  
to convince any sensible  
person that beam-weapon  
defense will make nuclear  
weapons obsolete.*

# Beam Defense Works!

Illustration by Christopher Sloan

## *A Point-by-Point Refutation of the SDI Critics*

by Paul Gallagher

U.S. BEAM-WEAPON EXPERTS have submitted reports summarizing their progress through mid-1984 on President Reagan's Strategic Defense Initiative (SDI)—the plan to defend against nuclear attack with antimissile systems based on land, sea, in the air, and in space.

The breakthroughs these scientists are reporting dramatically demonstrate the near-term potential for the whole range of antiballistic missile (ABM) defense capabilities,

*Artist's depiction of a homing overlay interceptor like the one that made the first direct-impact intercept of an ICBM reentry vehicle in June 1984. The Army's Homing Overlay Experiment, HOE, has an infrared sensor in its nose section for "homing" in on the warhead, plus three other sensing devices that track the target.*

from Earth-basing or low-Earth orbit and "pop-up" deployment, to geosynchronous orbit 22,000 miles up and beyond. As Dr. Lowell Wood of Lawrence Livermore National Laboratory emphasized recently, "My colleagues and I would not be expending this effort on a development for the 21st century."

The national laboratory reports were written to debunk the incompetent critiques of beam defense that dominate public discussion through the press. These critiques have the general authoritative character of the famous 1945 remark by President Roosevelt's naval aide Admiral William Leahy, "The atomic bomb will never go off, and I speak as an expert on explosions."

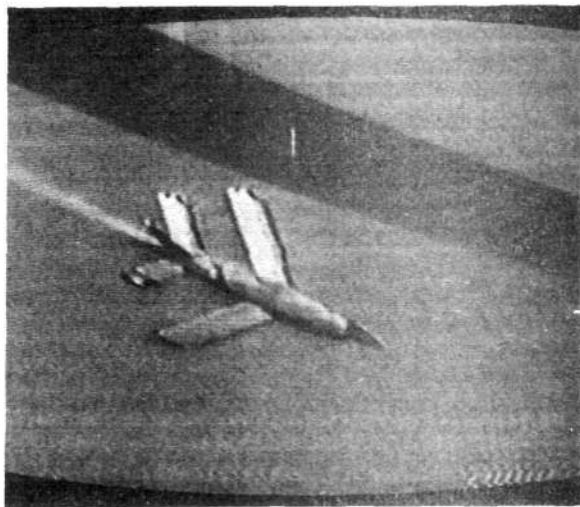

U.S. Air Force

**Figure 1**  
**BEAM WEAPON HITS DRONE TARGET**

*A laser beam fired by the Air Force Airborne Laser Laboratory hits a drone plane at the U.S. Navy's Pacific Missile Test Center, Sept. 26, 1983. The beam burned the skin of the plane.*

One such technology review paper on antimissile defenses was prepared at Los Alamos National Laboratory. It shows that the most publicized anti-ABM policy papers—in particular, “Directed Energy Missile Defense in Space,” issued in April 1984 by the U.S. Office of Technology Assessment (OTA) with the authority of the U.S. Congress—are outright scientific frauds, perpetrated deliberately by individuals whose political goal is to stop the Strategic Defense Initiative.

These fraudulent reports have been produced by what the *New York Times* has called the “Shadow Cabinet” of defense strategists, centered around a group of Harvard University and Massachusetts Institute of Technology physicists and arms-control “experts.” The most famous anti-beam-weapon report, written by former defense adviser Dr. Ashton Carter of MIT and published by the OTA, has been rendered into anti-“Star Wars” pulp by virtually every Sunday magazine supplement in the United States and Europe. Other well-known attacks on antimissile defense from the Union of Concerned Scientists were written by the same circle, which includes Carter, Richard Garwin of IBM, and Hans Bethe of Cornell University.

#### **Blatantly Incompetent Criticism**

The Los Alamos report, issued in May 1984, shows that beam scientists have surpassed every one of the “fundamental limits” that, according to Ashton Carter, would make beam defense impossible. Furthermore, it is now clear that the OTA report both *compromises classified information and fakes its claims that beam defenses will not work.* According to Deputy Secretary of Defense William H. Taft, who asked the OTA to *withdraw the report, it should “not be taken seriously by anyone attempting to understand*

either the design approach to multitiered ballistic missile defense systems or the potential effectiveness of such systems.”

The Los Alamos group insists that the OTA report is not merely wrong but *irrelevant* to the actual progress of the SDI: “When the errors are removed, the arguments lose their impact. . . . The OTA paper purports to demonstrate that the prospects for the SDI are remote. But the analysis provides no support for this conclusion, which must be viewed as essentially the personal opinion of the principal author.”

In fact, the national laboratory reports reveal that anti-missile beam-weapon technology, as well as ABM rocket-interceptor technology, is leaping ahead toward the stage of engineering development. “As to the factors that ‘conspire’ to make directed energy BMD remote,” the Los Alamos report concludes, “the first—that the defense of society [that is, population centers] is difficult—is true, but that *doesn’t make it any less worthwhile. The second—that ‘for every defense concept . . . a countermeasure has already been identified’—is incorrect.*” The countermeasures make for heavier, less maneuverable boosters and “buses,” and smaller warhead payloads—precisely what the boost-phase layer of defense is supposed to do, the report says.

## **REFUTING THE LIES OF THE BEAM CRITICS**

### **LIE #1.**

### **There is no defense against nuclear missiles.**

The most general attack on beam defense by proponents of Mutually Assured Destruction is the argument that even small leakage of warheads through a layered defense will devastate the United States. They claim that either a retaliatory or a preemptive nuclear strike will always succeed, once launched, because there are so many warheads.

In fact, ever since the first rocket interceptor (then called “antimissile missile”) systems were designed around 1960, the military commands of the nuclear powers have recognized that even these crude clustered interceptor defenses, spread around the defending country, could defeat an all-out launch of *single-warhead* missiles.

This fact is what led to the requirement for an offensive strike to deliver massive salvos of tens of thousands of separate warheads, decoys, and the like—and to repeat this more than once—to overcome such interceptor systems sufficiently to inflict significant destruction upon a country defended by antimissile missiles. If the massive, multiwarhead strike fails to inflict critical damage to military and related systems of the country under attack, then the attacker is at the point of defeat.

Nuclear missiles and other types of delivery systems cannot tolerate being hit from the outside with the kinds of radiant energy—electromagnetic radiation or particles—that they carry within their own nuclear explosive cargo. Nuclear weapons are a very highly organized, extremely energy-

dense form of energy, but they are carried to their target by vehicles powered by diffuse chemical energy. Therefore, nuclear weapon delivery vehicles have always been vulnerable to precisely directed nuclear explosives, used defensively. This has been known and proved by live test series since the end of the 1950s.

The defense can put small, precisely designed *nuclear warheads*, triggered by advanced proximity fuses, on rocket interceptors. This pits various forms of radiation from nuclear explosions, traveling at or near the speed of light, against mere metal shells traveling several hundred thousand times slower.

Very low frequency radiation (microwaves) from nuclear explosions kills the electronics of missiles and warheads. Very high frequency radiation (X-rays) from the explosions blows apart the missiles or the warheads themselves. Particle energy (neutrons) from the explosions, especially if enhanced in neutron warheads, disrupts the warhead materials and the nuclear explosive inside and destroys the electronics.

Thus, for 20 years we have had the means to use the radiant energy from small, precise nuclear explosives to destroy large numbers of attacking nuclear warheads far above our own territory, if we could use fast interceptor rockets to get the nuclear explosives up near the incoming warheads. These interceptors can sweep small areas of the sky clear of incoming warheads, destroying their electronics, fuel assemblies, and fuses so instantaneously that they cannot explode.

Scientists are now working on engineering the means to propagate the same kinds and flux levels of radiant energy over thousands of miles, as focused beams traveling at or near the speed of light. This would destroy missiles as they are just rising from enemy territory or as they are passing through space.

The same physical principles by which the radiant electromagnetic and particle energy is able to destroy missiles—the high energy density and the super-high speed of propagation of the radiation—also make possible highly accurate *sensing and tracking* of the missiles, buses, or reentry vehicles. Virtually every kind and wavelength of electromagnetic beam that is being developed to high power levels in order to disable missiles, can be used at low power levels to sense and track them at longer ranges. In addition, space-relay laser systems are being tested by the Soviet Union for the tracking of submarines under the ocean, and may eventually be able to attack the submarines themselves, not just their missiles after launch.

Thus, it was inevitable from the invention of nuclear explosives that the form of energy thus unleashed could, before too long, be precisely controlled and targeted to destroy the various kinds of missiles and planes that deliver those weapons. The radiant energy of nuclear explosives and the broader class of controlled radiation devices like lasers, microwave beams, particle beams, and so forth, would eventually become defensive weapons superior to their offensive forms.

So much for nuclear missiles being the ultimate offensive weapon.

## LIE #2.

### The Soviets can protect their ICBMs in the boost phase.

Critics have largely given up arguing that the physics of beam defense are impossible to engineer. They now admit that beams of the necessary power and focused brightness to destroy missiles can be generated and propagated, and mirrors can reflect and refocus them. Instead the critics

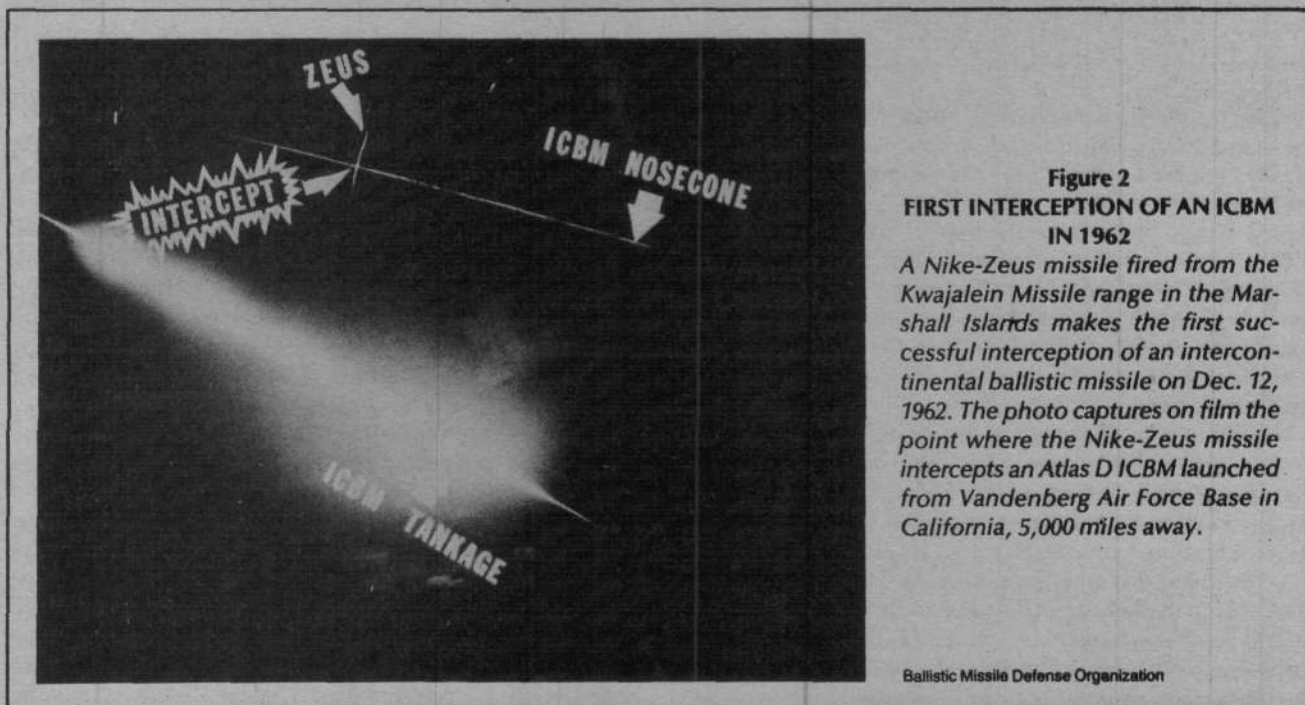

Figure 2  
FIRST INTERCEPTION OF AN ICBM  
IN 1962

A Nike-Zeus missile fired from the Kwajalein Missile range in the Marshall Islands makes the first successful interception of an intercontinental ballistic missile on Dec. 12, 1962. The photo captures on film the point where the Nike-Zeus missile intercepts an Atlas D ICBM launched from Vandenberg Air Force Base in California, 5,000 miles away.

Ballistic Missile Defense Organization

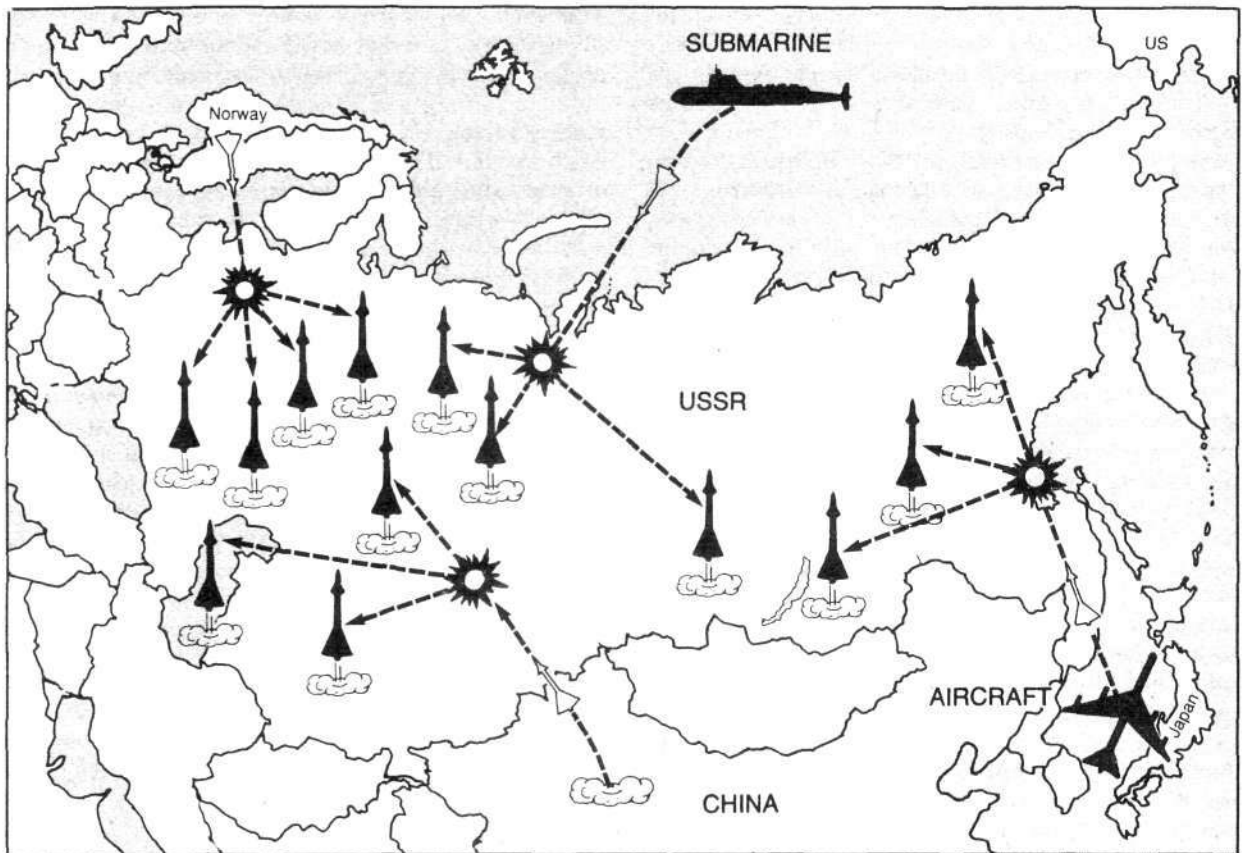

Figure 3

**X-RAY LASER POP-UP DEFENSE**

*Pop-up deployment is ideal for putting beam weapons into firing position as close as possible to the flight of the missiles they are seeking to destroy. When an ICBM launch is detected, defense X-ray lasers are "popped-up" into space on hypersonic rockets from land bases in Western Europe and Asia, from submarines, and from aircraft.*

now argue that it is impossible successfully to engineer these systems for battle against large missile launches and that it is impossible to defeat "countermeasures" aimed at protecting the missiles.

For example, the critics claim that during the boost phase, ICBMs are protected from beam attack by the atmosphere! Specifically, they claim that the beams of X-ray lasers—small, light, mobile, ideal beam weapons for attacking the boost-phase missile—cannot pass through any atmosphere at all. They say that the same "laws of nature" restrict particle beams as well.

Therefore, say these peace-loving experts, the enemy missile is safe until it leaves the atmosphere and emerges into space, about 2 minutes after the launch. All the Soviets have to do is build "fast-burn" boosters that will burn out within 1 minute, while the missile is still in the atmosphere. Then by the time it emerges into space as a target for X-ray lasers and particle beams, it will be a cold, dark object that infrared and laser sensors cannot find and track. Therefore, our lasers and particle beams will search in vain for the missile they could now destroy if they could find it.

These critics make a similar claim against the "pop-up" deployment of beam weapons—the concept of not putting the beam weapons in orbit in advance, where they themselves could be attacked, but launching them on fast-rising missiles from submarines *only* when an enemy launch was seen to be underway or immediately in preparation. "Pop-up" deployment is potentially ideal for putting the beam weapons up into firing position as close as possible to the flight of the missiles they are to destroy. The beam weapons can be "popped up" from submarines in Arctic waters, close to the Soviet Union and directly in the path of rising missiles headed over the Pole at North America. They also could be popped up from European or Japanese territory to attack missiles being boosted toward those countries.

Ingenious, say the beam-weapon critics, but it will never work, because of the curvature of the Earth! The beam weapon we launch must get high enough into space that its beam can be fired for a thousand kilometers or more without passing through any atmosphere, and then it must wait until its target missile emerges above the highest level of curvature of the atmosphere in between. At that point the



booster engines are burning out; by the time the X-ray laser or particle beam has a clear line of fire over the atmosphere, the missile has become a dead, cold carrier bus full of warheads, which our sensors cannot find or track.

First, let's deal with this fast-burn idea. In fact, the Soviets have no "fast-burn ICBMs," and the United States has only a study done by one contractor for the Defense Department who proposed to build fast-burn ICBM boosters by the 1990s. Current Soviet boosters (SS-18, SS-19) make bright, burning targets for 300 seconds (5 full minutes); the next generation MX-type solid fuel booster (and the Soviet SS-X and SS-NX types now being developed) will burn out in 3 minutes, so they will still be burning brightly far above the atmosphere.

What if the Soviets over the next 15 years or so spend tens of billions replacing most of their ICBM force with "fast-burn boosters" to defeat our lasers and particle beams? Then, as even "authoritative" critics like MIT's Ashton Carter admit, these new ICBMs will have much lighter payloads with fewer warheads; they will have a much more difficult and costly time of deploying decoys, and it will be three or more times as costly to deliver a single warhead to our territory.

In other words, this "fast-burn booster" will be a very expensive adaptation to U.S. defenses. By deploying it, the Soviets would make boost-phase defense a little harder, but all the other stages of defense, later in the missile's flight, much easier. And that's what boost-phase defense is all about.

Now for the critics' claim that the "laws of physics" prevent X-ray laser beams from passing through the atmosphere: In fact, these critics are just plain wrong. Although newspapers and television shows on "Star Wars" constantly repeat the litany that X-ray beams and particle beams, the most potent antimissile weapons, cannot pass through the atmosphere, national laboratory scientists have stated in their recent reports to Congress the actual results they are testing: X-ray beams can penetrate into the atmosphere from space, down to an altitude of 40 to 50 miles with current development designs. This is below the burn-out altitude of the fastest-burn "fast-burn booster" anyone is talking about. And with higher power levels and better focusing, there is no reason these X-ray lasers should not burn their way down much farther into the atmosphere.

The same thing is true of beam of neutral particles generated by a particle-beam accelerator. Ordinary high-power chemical lasers, and "projectile gun" accelerators, can propagate down into the atmosphere, of course, although they carry heavy fuel loads and cannot be "popped up"; they must be in predetermined low-Earth orbits to begin with.

There are many devices and many ways being developed to attack missiles even during a very short boost phase, and the atmosphere will not protect them, despite the claims of the "ICBM protection society." Thus, there is no need for our antimissile defensive systems to "wait" after sensing the launch of the missiles, because "one can see all the way to the ground" from space, including through cloud cover with infrared sensors. The defense can attack as soon as the missiles leave their silos.

### LIE #3.

## Missile skins can be hardened against beams.

Next, the critics, insist, the Soviets will merely harden their boosters so that beam weapons cannot destroy them. Or, they will design boosters that cover their surfaces with constant showers of water, to cool their skins against the burning of the laser. As you might suspect, this is more wishful thinking by the "ICBM protection society."

First, let's take particle beams: The critics say that shielding against neutral particle beams would be "heavy, but still an attractive countermeasure." In their most authoritative reports, the critics assume that only a few millimeters thickness of lead shield will be coated on the booster. However, the fact is that high-energy particle beams will penetrate 4 centimeters—400 millimeters—of lead. The actual lead weight required to stop them would be 20 times as much per centimeter of surface as the authoritative beam-weapon critics claim. In fact, the lead shielding required would weigh more than the entire load the booster is carrying into orbit—the carrier "bus" and all of its warhead reentry vehicles. So each "shielded" booster would be much heavier and more costly, and thus would have to carry many fewer warheads, making later stages of defense easier.

The same is true when it comes to hardening the missile against laser beams. For this, the critics say, the Soviets will multiply the hardness of their boosters by 20 times. Today, a few kilojoules of laser energy per square centimeter of the booster will burn through it very rapidly. Therefore, the Soviets will harden this to 10, 20, or even 30 kilojoules per square centimeter, say the critics. How? Again, by adding that lead shielding to the missiles, which means fewer warheads traveling toward our military forces, industry, and cities. Another suggestion is that they will add ablative material like that on the bottom of the reentry vehicles in Project Apollo, which adds not only weight but drag, slowing down the booster as it rises through the atmosphere.

And what will the Soviets do to counter the lasers that are now being developed to destroy a hardness of 10 to 30 kilojoules per square centimeter of booster? Well, say the critics, the Soviets will make the boosters *spin* as they rise, spreading out the laser burn on the surface.

This spin countermeasure is a trick that has not been tested and would exact unknown penalties against the accurate *guidance* of the missile, which is crucial to its success as a weapon. What's more, if the booster is spinning, the laser merely has to track its own burn-spot on the booster as it turns, since many types of antimissile lasers will disable the missile before it could spin through even one revolution. The laser can do this because in addition to a radiation beam to disable the missile, it will probably have a laser "probe" beam to track the missile as well, like a battlefield laser gun sight. Thus, once the laser and its probe beam are on the missile, they are "locked on" to the missile surface as it burns; they no longer need the other sensor probes that found that missile for them in the first place.

The X-ray laser, critics admit, will kill the vulnerable booster with an instantaneous, hammerlike blow: The high-

**Figure 4**  
**THE ICBM TRAJECTORY**  
*ICBMs are most vulnerable in the boost phase. Current Soviet boosters, the SS-18 and SS-19, make bright, burning targets for 5 full minutes.*

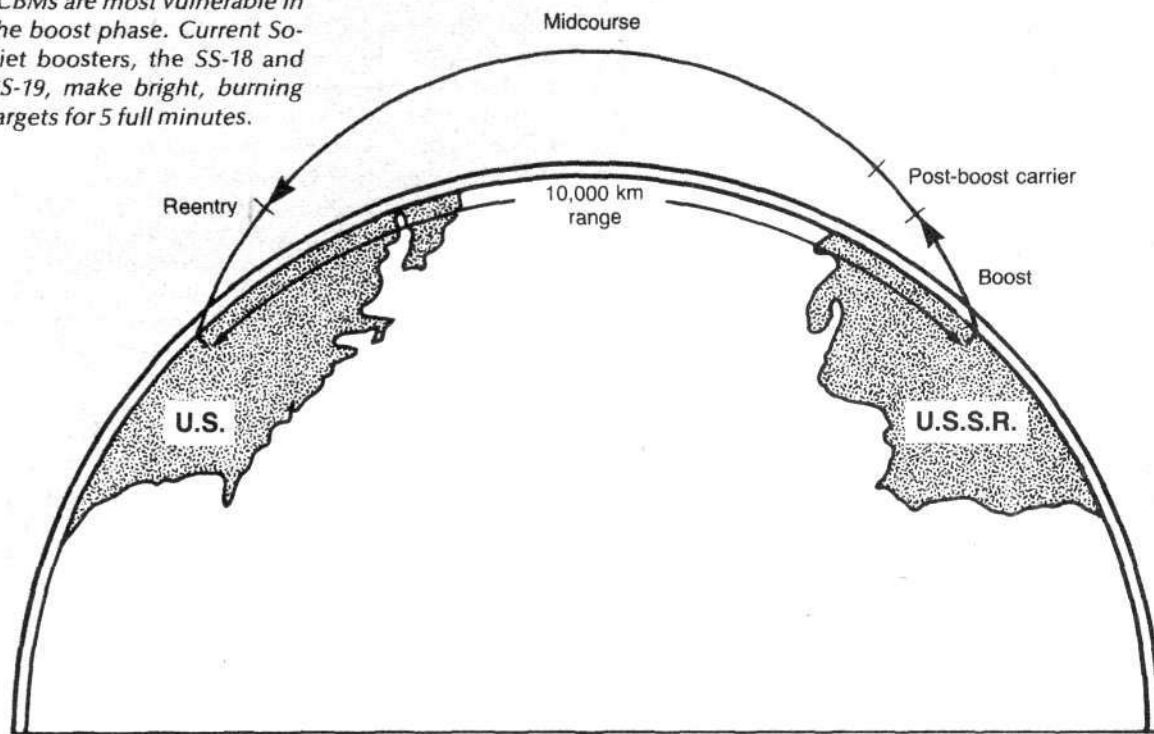

power X-rays literally burn off the booster's outer layer of skin in an explosive instant, sending destructive shock waves into the interior. Thus, no "hardening" will stop the X-ray laser. So, the beam-defense critics claim, in addition to carrying layers of lead, spinning, and "fast-burning," the Soviet boosters will also send out showers of lead dust to interfere with the X-rays.

This might work if the booster did not have to defend itself with such lead dust showers until after it was out into space. However, since the X-ray laser can attack the booster while it is still in the upper atmosphere, these lead dust clouds will be swept away by the atmosphere that is rushing past the missile. Unless the booster is loaded with enough lead dust to spray clouds of it for 45 seconds or more, this "countermeasure" won't work.

#### LIE #4.

### Too many beam weapons would be required.

As we have shown, ICBM boosters are big, bright, glowing, slowly lumbering, vulnerable targets. Furthermore, as they rise through the thinning atmosphere and out into space, beam weapons have the lethal power and concentration of energy to disable missiles, using controlled radiation that moves at the speed of light against mere metal—whether it be spinning, showering, ablating, or even dancing the hora.

The next argument, made famous in two of the most publicized and so-called authoritative anti-beam-weapon reports—the Office of Technology Assessment report to the Congress and the Union of Concerned Scientists report—is that there could never be enough beam weapons to defend against an all-out attack. As the missile flight rises and heads for the United States 25 minutes away, these experts say, there cannot possibly be enough beam weapons in position, in orbit, or popped up, close enough to the missiles and accurate enough to destroy them. Too many of the beam weapons, they insist, would have to be elsewhere around the globe in their orbits at the time of launch, and therefore "out of range." This is what gives rise to the very well-known scenarios drawn by the critics, in which the United States and its allies would have to put in orbit literally thousands of antimissile lasers, in order to have enough over the Soviet missile fields at all times to attack the missile launch. This, they say, would require so many millions of tons of chemical fuel for the lasers to be put in orbit that the Space Shuttles would be flying for centuries to lift it all up there.

For this to be the case, the sorcerer's apprentice of fairy tale fame—not our nation's best energy-beam physicists, space engineers, and technicians—would have to be planning beam defense, simply flooding space with lasers in the least efficient way with no planning at all. First, such a novice puts 32 lasers in four orbits around the Earth, 8 beam weapon positions in each orbit. Then he puts 32 more at

the same positions; then 32 more, and 32 more, until he has 10 lasers sitting on top of each other at each orbital position. No wonder he needs a lot of lasers! This is like trying to tile a floor by choosing 32 tile squares out of the whole floor, and piling up tiles to the ceiling on those squares, leaving the rest of the floor bare!

Fortunately, our military and laboratory beam-weapon planners have planned to spread out the laser stations a little more intelligently. In fact, just 100 to 150 laser stations could cover the Soviet missile fields quite well at all times. The average range at which a laser would be firing at boosters might be 1,000 miles or less. At this range, each laser, after all, can attack one booster after another, killing up to dozens.

Because the critics assume big holes in the laser defense and lasers firing at missiles from very long distances, they also assume that the laser beams will spread out as they travel these distances, resulting in the beam hitting a large circular "spot" on the missile, without great intensity or brightness. If you do things that way, each laser does need many tons of fuel and needs to stay locked on the missile surface for many seconds to disable it. This is, indeed, very hard to do.

However, beam scientists point out, our lasers will be using "battle mirrors" to refocus their beams. These mirrors will be in many orbital stations around the Earth, spaced in between the lasers and their missile targets. These mirror "relays" are like additional lasers, refocusing the beam against the missiles from fighting positions much closer to the missiles than the laser itself. This makes for a shorter effective range, and a smaller, brighter, more intense "spot" of laser radiation burning through the missile skin. Thus, much less fuel is needed than the critics claim, and scientists estimate that 100 tons of chemical fuel could be enough for the whole constellation of laser stations. Ten launches of the Shuttle could bring that much fuel into orbit.

#### Pop-up Relay Mirrors

Taking this one step further to greater effectiveness, many of the lasers and their fuel can be kept on Earth! Only the relays of battle mirrors need go up into space, and they can be "popped up" because they are much lighter. Two relay mirrors can relay the lethal laser beam around the Earth at the speed of light until the last "battle mirror" refocuses it onto the missile from close range.

This will never work, cry the critics; everyone knows that laser beams are only light, and as they travel up through the atmosphere they will be distorted and spread. But here the critics are deliberately misstating the state of the art in optics, one of the most astonishing precision fields of technology today. Two years ago, a prestigious optical science conference in San Diego was suddenly thrown into controversy when the Defense Department asked that many of the papers prepared for it *not* be presented there. Why? Because the work to be discussed was the technology of "nonlinear, adaptive optics," which is being developed precisely to enable high-power laser beams to burn their way through tens of miles of atmosphere—and out into space. By all public reports, this is succeeding.

Very large mirrors not only reflect the laser light; they

(a) Even deployment

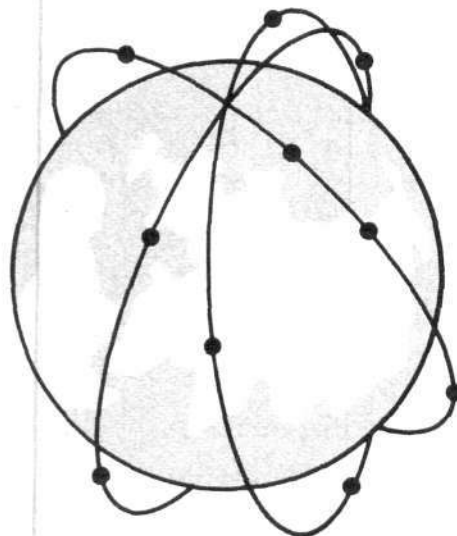

(b) Clustered deployment

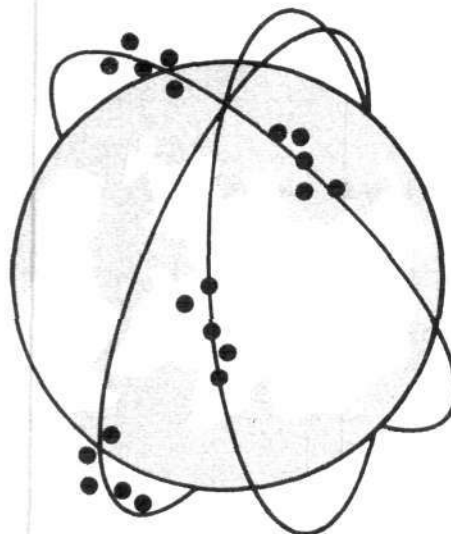

**Figure 5**  
**DISTRIBUTION OF DEFENSIVE SATELLITES IN**  
**NEAR-EARTH ORBIT**

*The Los Alamos National Laboratory and the Department of Defense have chosen the even deployment configuration (a), deploying battle stations evenly along their orbits. This is efficient and leads to a much smaller proportion of the defense satellites being absent from the area of the launch.*

*In contrast, the Office of Technology Assessment report on beam defense chose the clustered deployment configuration (b), in which the satellites are clustered at a few points along each orbit. As both the Los Alamos Lab and the DOD's Office of Strategic Defense have pointed out, this configuration seems to have been chosen to decrease the efficiency and effectiveness of the battle stations.*

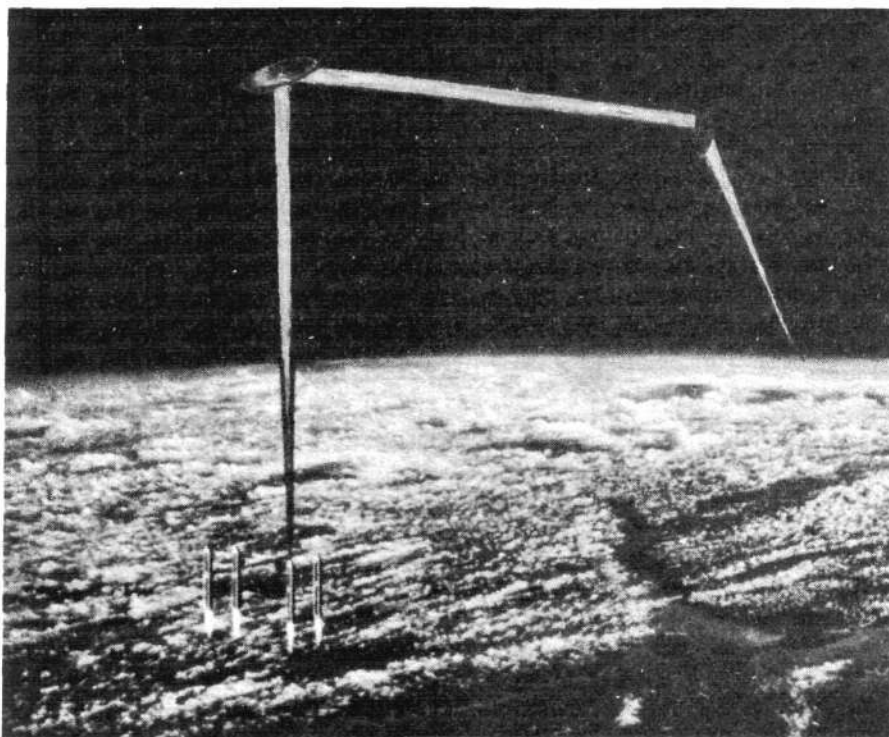

**Figure 6**  
**LASER MIRROR RELAY**  
**SYSTEM**

*Laser mirror relays will refocus the beam against the missiles from fighting positions that are much closer to the missile than the laser itself. This means a shorter effective range and a more intense spot of laser radiation to burn through the missile skin.*

can also refocus it, actively correcting for distortions in the laser light that hits them. In fact, our relay mirrors in space will have small laser beacons on them that shine their beams down on our ground-based lasers! With the information gathered by this "probe" beam on its way down through the atmosphere, the optical mirrors and advanced lenses of the laser below can *predistort* the high-power antimissile beam to compensate for the condition of the atmosphere above it. The high-power beam can then "burn through" all the way up into space and arrive at the relay mirror focused and bright.

So far, this "shield full of holes" argument by the critics concentrates only on chemical-powered lasers, because the critics imagine that in this way they can mislead the public with images of vast oceans of chemical fuel that must be carted up into space. However, this would be the case only if the sorcerer's apprentice were in charge.

With the lightweight "pop-up" systems like the X-ray laser, in which a small nuclear explosive fires 50 beams of superlethal X-rays at 50 missiles at once, these arguments obviously do not apply. In fact, leading beam-weapon critic Carter says in the OTA report: "X-ray lasers on submarines stationed in the Kara Sea or the Sea of Okhotsk could climb to firing position before burnout" of the Russian ICBMs, and each laser could attack over 100 boosters. Thus a single submarine, launching 10 "pop-up" rockets carrying X-ray lasers into firing position, could attack a massive Soviet launch of 1,000 ICBMs.

Why then do Carter and his friends in the "ICBM protection society" assert that an array of X-ray lasers will not be able to wipe out the missile threat?

Well, they say, look at the insides of the X-ray laser or the

neutral particle beam. (This, of course, is something we, the general public, are not authorized to do, nor are the laboratory scientists authorized to tell us about these "insides" in any detail. Yet the critics, who are not working on these devices, claim not only that they know what goes on inside X-ray lasers like the back of their hand, but that we should believe them.) Light lasers, the critics say, make their beams precisely focused, pointed, and bright by multiple reflections back and forth between internal mirrors. But, they claim, X-rays cannot be reflected from mirrors, because their frequency is so far above visible light and their radiation is so intense it would destroy the mirror's metallic surfaces. Thus, X-ray lasers, they say, are not really lasers but bursts of coherent radiation, and they spread out very rapidly, making them impossible to focus onto a missile at any great distance.

To quote Carter, "Since X-rays are not back-reflected by any kind of mirror, there is no way to direct the X-rays into a beam with optics like the visible and infrared lasers." These critics also insist that particle beams "diverge" very rapidly for related reasons and lose their precision and brightness except at very short distances.

What do the scientists who are actually working on beam weapons say about this argument? To quote one group at Los Alamos: "That is simply incorrect. Experimental optical devices for X-rays have actually been developed, which enable one to perform the same sort of optics with X-rays which are done for visible light." They answer the criticism of neutral particle beams similarly.

Remembering that the X-ray laser and neutral particle beams are by far the most powerful and most lethal antimissile devices against which hardening attempts are use-

less, the ability to keep these beams just as focused and just as bright as ordinary lasers means that an X-ray laser beam could, in fact, destroy a missile from geosynchronous orbit, 22,000 miles up. Think about that. From geosynchronous orbit, boosters are really sitting ducks in a shooting gallery. The laser itself at that altitude is virtually invulnerable to any kind of antisatellite attack. And it is motionless above a single spot on the Earth's surface. Therefore, 100 X-ray lasers could be stationed permanently directly above the Soviet missile fields. Even if each one emitted only a few high-intensity beams as it exploded, this armada of lasers could severely thin out any missile launch, leaving the rest to be attacked by particle beam and laser devices in low orbit and on the ground.

## LIE #5.

### The Soviets will saturate our post-boost defense.

We have shown even our critics that boost-phase interception of missiles exercises a great leverage against the success of a preemptive missile attack as a whole, even if some boosters get through. Some critics claim that the Soviets could minimize this leverage, by launching all 1,400 or so of their boosters within a few seconds, thereby "overloading" the boost-phase interception systems. Perhaps, but such instantaneous total launch pays a penalty at the other end. Missiles launched instantaneously will deliver their

warheads to their targets over a period of several minutes, rather than all at once, making the terminal defense job easier.

Missile interceptors and particle beams stationed at terminal-area defense locations in the United States could attack the first warheads arriving at the targets along the Canadian border; then the next wave arriving across the central belt of the country; then the final wave of warheads hitting targets in the South. This would enable the defenders to reply with more concentrated, more effective fire at the incoming warheads.

Conversely, to saturate our terminal defenses, the Soviets would want to launch their missiles in salvos over several minutes, which would give our boost-phase layers "several shots each," knocking out more of the launch in boost phase.

However, since some missiles will get through, we come next to post-boost-phase defense, when beam weapons go to work against the warhead carriers or "buses" that are released by the boosters. If 100 buses have gotten through, the buses start maneuvering to launch their 500 to 1,000 warheads.

Now the critics say something cute about attacking these buses: They say it just isn't worthwhile, that "they are targets of declining value as they release their warheads." The critics also claim that buses are easier to harden because they are smaller than the boosters.

The second of these two statements is particularly foolish, because the bus is a canister with a metal-plate door

**Figure 7**  
**NEUTRAL BEAM DEFENSE FOR THE BOOST, POSTBOOST, AND MIDCOURSE PHASE**

A particle beam accelerator in near-Earth orbit at an altitude of 600 miles engages missiles in the boost, post-boost, and midcourse phase of their trajectories. A diffuse laser beam directed from a relay mirror in geosynchronous orbit is used to light up the neutral beam so that it can be easily directed onto the missiles in the same manner in which tracers are used by anti-aircraft guns.

The Los Alamos lab report comments: "Neutral particle beams would have the very high effectiveness against postboost vehicles, which are heavily dependent on electronics and can stand little interruption in their function, and reentry vehicles, which are exposed for a very long time and very susceptible to neutral particle beam effects in midcourse."

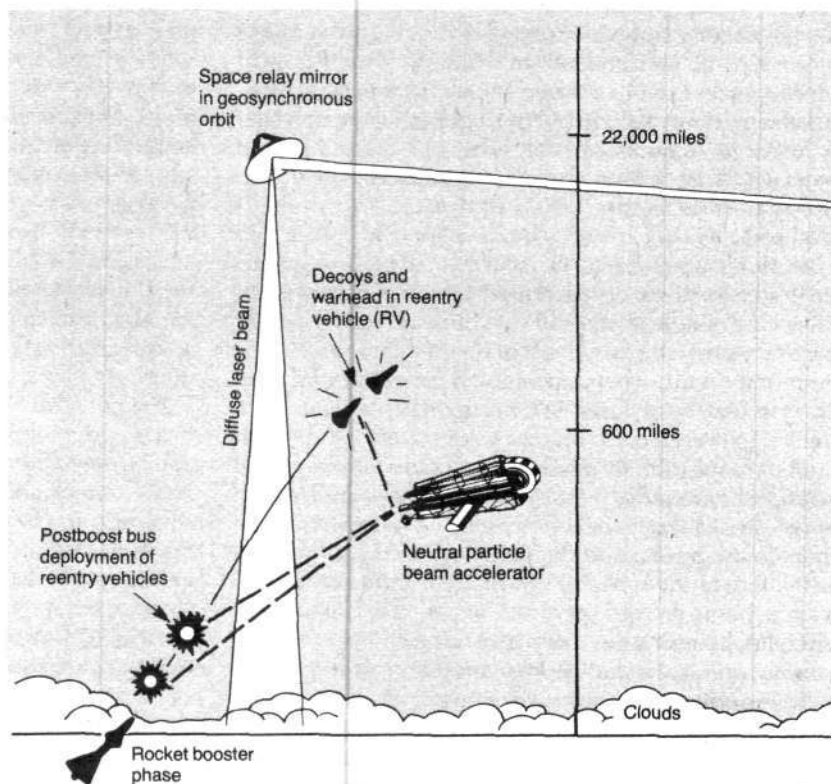

over its front end; and the door, which is built in segments, must open up in order for the warheads to be released. Hardening a segmented door that must split open precisely in space is a very difficult task indeed, a little like trying to "harden" the Shuttle bay doors with thick lead coatings, and then expecting them to function properly.

Another strong discouragement against hardening these "buses" is that they are the last stage of the missile that does any maneuvering; therefore, the penalties for any addition of weight to this stage are greater, in terms of fuel requirements and loss of maneuvering accuracy, than any previous stage.

What the critics are really saying, with their assertion that the bus is "a target of declining value," is simply that the warheads will drift to the end of their trajectories even if the bus is destroyed. But if it is destroyed, those warheads will come nowhere near their targets. They will tend to fly all the way back down to Earth in dense clusters, since it is the maneuvers of the bus that direct them toward separate targets. Thus every bus we can destroy makes the attack less effective militarily and the warheads easier to destroy by midcourse and terminal defenses later in the flight.

More serious critics claim that the bus is simply hard to see—hard for sensors to pick up and track, because it has no bright, hot plume behind it and is not as large as the booster. Also, they say, it can start launching decoys right away, and thus our sensing and tracking system will get "overloaded" just at the beginning of the warheads' long, 20-minute free-fall flight through empty space.

This classic argument against antimissile defense—that the defensive sensors and trackers will always be overloaded by the sheer numbers of objects to track and discriminate—might still be true if all we were using for our most advanced tracking were infrared sensors that pick up heat. This is the primary technology for tracking boosters, which give off large amounts of heat. However, these infrared sensors will be tracking every booster that gets through the boost-phase interceptors, and when that booster burns out and releases its dark, cold bus, the sensors will have told our computers the trajectory of that bus. So finding the bus again in space will not be like finding a needle in a haystack, but finding a needle on one side of your knitting, when you know exactly where you stuck it in on the other side!

More important, we will use much more than infrared sensing to find these buses. We will use lasers to illuminate them. In fact, when our lasers are in battle, even those that are out of range to "kill" missiles are not too far away to be used as probes to sense them. Many other laser and particle beam probes will be launched as well. The visible lasers will illuminate the buses; and the particle beams and infrared lasers will heat them slightly so that the infrared sensors can track them.

Virtually all sensing devices are, in fact, "coherent energy beams" of one sort of radiation or another, just as the antimissile weapons are. When we are just passively using the beam to sense something, as in radar, the beam cannot find anything that is smaller than the beam. But "when we are actively illuminating and heating a target," beam scientists tell us, "we can produce a very bright return" to our sensors. Then we can perform the process known as "signal

processing," or beam division, as is done with the advanced class of radars known as "phased array radars." We can then "see," even at great distance, very small objects and pick out such small objects from large crowds. By the slight differences in the heating or lighting of these targets—differences that are picked up by the sensors—our computers can tell which are the heavier buses or warheads and which are the lighter decoys, aerosol sprays, balloons, and other diversionary devices.

It may take some minutes for this sensing and discrimination process to occur, but the bus phase precedes the longest phase of the warhead flight, the free fall through space, which takes some 20 minutes in all. Any buses we knock out will make this long "duck shoot" easier in the discrimination and tracking of the ducks.

To quote the report of Los Alamos beam scientists, "Neutral particle beams would have very high effectiveness against post-boost vehicles, which are heavily dependent on electronics and can stand little interruption in their function. . . ."

## LIE #6.

### Midcourse defense is too difficult because there are too many warheads, decoys, and so on.

The midcourse of the nuclear missile attack is by far the longest of the 30-minute flight time—a period of 20 minutes of free ballistic flight through space, in which the major problem confronting the defense is the very large number of warheads, decoys, and other objects, totaling thousands, even if up to 90 percent of the warheads have been destroyed or disabled in boost-phase and bus-phase defense. They reach a maximum altitude of 700 to 900 miles, depending on how they are launched, and are therefore up above many of the beam weapons attacking them, but still passing within fairly close range of line after line of antimissile weapons. They are also heading over the North Pole in a "corridor" only 2,000 to 3,000 miles wide as they fly toward the United States, so that beam weapons, in polar orbits or "popped up" into space over polar regions, "pass in file" across and under the phalanxes of warheads flying over them.

The critics say that in this phase there are truly so many objects to track and discriminate, selecting the warheads and "killing" them is an impossible task, even if only 1,000 remain on course. These warheads, they insist, are very small and nowhere near as vulnerable as the booster, being much harder. In addition, they say, the region of the engagement will be the scene of nuclear explosions as Soviet submarines launch missiles into space to detonate their nuclear explosives there, both to "pin down" the U.S. ICBMs in their silos and to make sensing of Soviet warheads impossible.

However, although nuclear explosions high in space may make infrared heat sensors and ordinary optical telescopes worthless for use in detection, they do not stop higher-wavelength radiation—X-ray and ultraviolet—from getting through and back again with tracking information on the

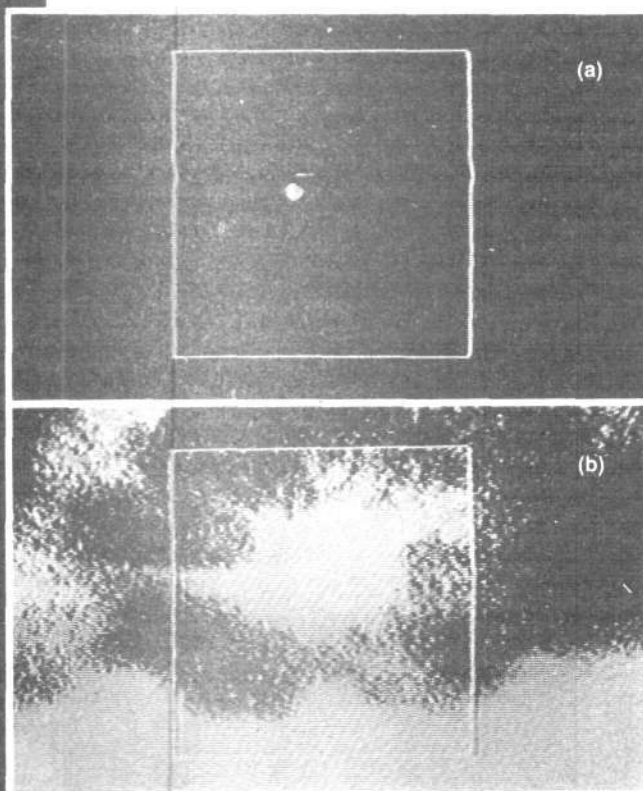
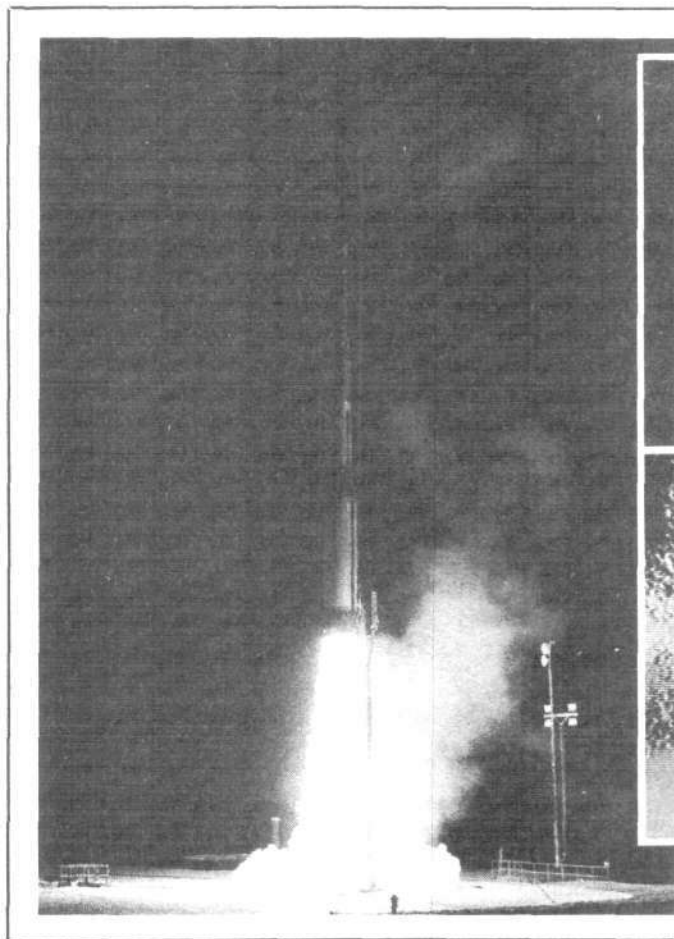

**Figure 8**  
**ARMY HOMING OVERLAY EXPERIMENT (HOE)**  
**SUCCESSFULLY INTERCEPTS AN ICBM**

*The Army's Homing Overlay Experiment lifts off from the Kwajalein Missile range in the Marshall Islands on its way to the first intentional direct-impact intercept of a reentry vehicle from an ICBM, June 10, 1984. Less than 10 minutes later, the HOE vehicle's third stage collided with the reentry vehicle, shattering both vehicles.*

*Inset (a) is a photograph made from video recorded through a 24-inch tracking telescope at Kwajalein Missile Range. It shows the rocket plume from the HOE vehicle just a fraction of a second before it collides with the dummy warhead from the ICBM. The short horizontal bar above the plume is a tracking marker. The rectangle defines an area in which the telescope automatically tracks objects. The five smaller points of light are stars.*

*Inset (b) shows the clouds of debris that followed destruction of the target ICBM reentry vehicle, which was flying from right to left. It is estimated that the body-to-body collision smashed it into approximately a million pieces. The larger cloud in the center is debris from the HOE vehicle.*

warheads. In fact, X-ray and ultraviolet beams have been used for years in nuclear weapons tests to "see" inside the plasma fireball. Such beams have had the same uses in diagnosing what is going on inside plasmas in experimental fusion energy machines. This is called "backlighting" with X-rays or ultraviolet, and is the most sensitive and "active" means of detection and tracking in space—but it must be combined with infrared, optical, and radar scanning.

The beam weapons themselves are also trackers—what they don't hit with enough energy to disable, they *detect!* And in the midcourse phase, the greatest variety of antimissile devices will be at work, with the greatest expanse of time for them to track and attack the warheads.

Neutral particle beams, for example, according to the Los Alamos report, "have very high effectiveness against reentry vehicles, which are exposed for a very long time and very susceptible to particle beam effects in midcourse." A space-based version of the neutral particle beam is now expected in prototype *during the 1980s*. Free-electron lasers are also being prepared for space basing. These lasers are superefficient in converting their fuel energy into beam power and can operate at the high frequencies (visible and ultraviolet) that are desirable for both detection and destruction of warheads in midcourse.

So-called *excimer lasers*, which are powerful and efficient lasers to be based on Earth, also produce these desirable high frequencies up into the ultraviolet region. This makes them easy to refocus from relay mirrors that do not have to

be very large, because they are reflecting radiation with a short wavelength.

In addition, when the warheads approach within 500 miles or so of their targets, they can be knocked down and destroyed outright by *homing interceptor rockets*, as the U.S.

Army proved in spectacular fashion June 10, 1984. The warhead that "homing overlay interceptor" knocked out was tracked by a combination of three sensing devices: an aircraft-based infrared sensor, an optical telescope, and a ground-based radar. In addition, the interceptor had an infrared sensor in its nose section for "homing" in on the warhead.

The beam critics are also ignorant about the full potentials of particle beams that make warheads so vulnerable to them. Particle beams can be "tuned"; this means that if the range over which the particle beam will travel is known with fair accuracy (as it would be in a midcourse interception of a warhead), then the particle beam can be generated in such a way as to "save its energy" while passing through the distance to the target, and deposit all that energy very suddenly in the metal skin of the target and *within the nuclear fuel* inside. This turns the insides of the warhead into nuclear mush, so to speak.

## LIE #7.

### Even with terminal defense, the nation will be destroyed.

In the terminal defense stage, only 200 to 300 warheads will still be flying toward their targets, as the midcourse attacks by phalanxes of beam weapons end. These warheads will reenter the atmosphere over the United States, only 100 seconds or so from their assigned destruction of those targets. The thousands of remaining decoys, balloons, and so on, slow down and burn up in the atmosphere, leaving the warheads easy to discriminate and track by simple optical means and with radar.

Now, say the opponents of antimissile defense, even if we have gotten this far and knocked out 95 percent of the warheads in a full launch, the nation is lost. Even if only 15 or 20 of these hundreds of warheads still on course get through to their targets, the destruction will be devastating. What's more—and this the critics imagine to be conclusive—even those warheads that are intercepted after this point will detonate, because of a technique called "salvage fusing" available to the attacker. Although this technology is not perfect, it is thought that warheads can be "fused" late in the flight to detonate as soon as they sense contact with any attacking object or burning on the skin of the warhead.

The critics are dead wrong on three counts. First, and most general: If we can knock out 90 percent of those remaining reentry vehicles, the damage done by the 20 or so that reach their targets may be locally devastating, but it will not be *militarily* significant against our retaliatory forces. The attacker will have thrown his best punch without doing dramatic damage to U.S. military strategic capabilities. The enemy's slow-moving bombers and cruise-type missiles will be left to face our entire strategic capability. The enemy will have thus lost thermonuclear war. Should the Soviets know that this result is the *likely* outcome of attacking the U.S. beam defense—or even that it might come out that way—they face the most powerful possible deterrent to attacking. Once a nation has launched a course of war or war confront-

ation, it is not the fear of retaliatory destruction alone that can then deter that nation from attacking at some point, but rather the fear of losing the war through that attack.

Second, those 200 to 300 remaining, highly visible warheads can be attacked with "everything we can throw," and today's frontier accelerator technologies will allow us to throw quite a lot against those warheads, at very high velocities and accuracies. Particle beams will be the technological front end of terminal defense, electron beams, beams of muons or heavy electrons, proton beams, positrons, and so on. Today's large accelerators, used for atomic physics research, are capable of combining high energy per particle with high current (a large stream of particles). And, like the neutral particle beams discussed above, they can be "tuned" for very specific deposition of their energy in the first few centimeters of a warhead's surface, to destroy it. Salvage fusing, since it rests on electronics, will be too slow to detonate the warhead in most such cases.

These electromagnetic accelerators can fire at very rapid rates, hundreds and even thousands of times per second. The same accelerators that send up particle beams, can also be used to aim and electromagnetically accelerate larger projectiles, the size of rocks, to velocities up to 5 to 10 miles per second. These will smash into the warheads and knock them off course, although their salvage fuses could then detonate them.

The same is true of the very fast-rising antimissile interceptors for terminal defense, of the "Sprint" type the United States made 20 years ago, but no longer produces or stockpiles. A slower variant, called "Patriot," is produced today for anti-aircraft defense. The Soviets, however, have a large variety of advanced terminal interceptors for ABM defense already deployed around Moscow and warehoused elsewhere in the country—one of their many gross violations of the 1972 ABM Treaty.

These interceptor rockets, because they can rise and home in on missiles over hundreds of mile ranges, will be used for "area defense," not just last-ditch defense of point targets. Area-defense interceptor bases will be established at a certain number of locations around the country in a "grid," each with responsibilities to "cover" one geographical region but with capabilities to "help out" by overlapping into another.

Now, the critics still insist, you may hit a lot of these warheads and knock them off course, but many of them will still detonate because of "salvage fusing"; their high-altitude fireballs will wreak tremendous damage below, as have nuclear weapons ever since Hiroshima. But these opponents of beam defense are wrong again—if we give up the currently widespread taboo against putting nuclear warheads on our interceptors. The defense can sweep out warheads from areas of the sky even under close-in attacks—including very short-range attacks from offshore submarines, or the intermediate-range and tactical rocket attacks Western Europe would face from the Warsaw Pact—if the defense can use hyperacceleration interceptors armed with nuclear warheads. The intense radiation from the small nuclear explosives on the interceptors, including EMP (electromagnetic pulse), microwaves, and X-rays, destroys the electronics of attacking warheads instantaneous-





**Figure 9**  
**TERMINAL DEFENSE SYSTEM**  
*Particle beams will be the technological front end of terminal defense. These can be "tuned" for specific deposition of their high energy in the first few centimeters of the warhead's surface.*

ly, preventing salvage fusing, as it destroys the warheads themselves before they can explode. This is effective for a range of 5 miles or more around the interceptor, depending on its altitude when it detonates.

If the warheads are neutron warheads, the defense can do an even better job. The neutron flux travels farther from the interceptor detonation, scrambles nuclear fuel and electronics on attacking reentry vehicles, and fries attacking bombers and their crews. Small nuclear warheads are powerful defensive weapons against their more destructive offensive versions.

## LIE #8.

### **Beam weapons can't defend against submarine-launched missiles.**

Since President Reagan's announcement of the SDI on March 23, 1983, its most violent and continual "critics" have been the Soviet command. One of their most highly publicized rejoinders to the U.S. beam-defense program has been to aggressively station more missile-launching submarines close to both United States coasts. Your antimissile defenses, the Soviets growl, will never stop these submarines from getting their warheads to their targets, some only a few minutes flight time away from their stations. Not only are the flights of submarine-launched ballistic missiles, SLBMs, short, but they are low in trajectory, staying within the atmosphere for virtually their entire course.

But submarine-launched missiles are by no means invulnerable to a fully deployed, multilayered defense. First, from boost phase through reentry, these missiles travel at significantly slower velocities than ICBMs. That makes them easier to track and hit.

Second, submarines can only launch one of their missiles at a time, or, in the case of the largest subs, two or perhaps three. After the first missile or small salvo leaves the water, the sub's position has been identified. The next flight of slow-moving missiles that boost out of the water 1 or 2

minutes later, can be attacked by aircraft-based lasers, such as the one tested in May 1983 by the U.S. Air Force against Sidewinder missiles, or by beam weapons popped up from aircraft to follow the missiles and fire at them.

Third, as the missiles near their midcourse, they can be attacked from space and by beam weapons popped up directly in their path from Earth. Pop-up defenses are particularly effective against slower-moving missiles with short flight paths, since the beam weapon can pop up into a firing position that is at very close range to the booster or warhead. What's crucial is that because SLBMs stay within the atmosphere for most of their flight, they have much more difficulty launching decoys. These decoys and camouflage items hit the drag of the atmosphere as soon as deployed, and are slowed down and fall behind the warheads, which therefore remain clearly defined as targets.

Finally, when the submarine-launched warheads come in at their targets, they are still traveling 25 percent more slowly than ICBM warheads. Thus our interceptor missiles, projectile accelerators, and particle beams can track and hit them more easily.

It should be clear that what we have said about the greater ease of defending against submarine-launched missiles, applies equally to the intermediate-range nuclear missiles (SS-20s) that threaten Europe and Japan and to the shorter-range tactical nuclear missiles like the SS-21. Imagine how foolish it is, then, for the opponents of beam defense to claim that the SDI "offers no defense against cruise missiles, bombers, and other air-breathing threats"—since these threats travel 30 to 50 times slower than even submarine-launched and intermediate nuclear missiles.

For anyone interested in the defense of the country and a more stable strategic situation worldwide, it is clear that beam weapons work and that the reality of technology development refutes the lies of the anti-beam-defense lobby.

*Paul Gallagher, the executive director of the Fusion Energy Foundation, writes, lectures, and debates frequently on beam-defense issues.*



*The ancient science of astronomy must be revived to educate the population and defeat astrology, the secret weapon of the oligarchy in its successful age-old war on reason.*

# Astronomy

# The Foundation Of Scientific Method

by Jonathan Tennenbaum

RECENTLY A WEST GERMAN newspaper reported that one of the leading items of business expense in German firms is the payment of astrologers. Many firms, it seems, have a "house astrologer," who provides star readings as the basis for decisions about whether and when to sign contracts. In Italy, one of the most famous European physicists, Professor Amaldi, who was head of the CERN particle accelerator in Geneva and is a leading member of the Pugwash disarmament movement, is presently carrying out experiments on how dying animals send electromagnetic signals to the center of the galaxy. Tens of millions of housewives read the daily horoscope sections of their fashion magazines, sandwiched in between the latest gossip about the kings and queens and barons of Monaco and Lichtenstein.

This is not just a European phenomenon. Robert Mc-



*Above: Illustration of the zodiac. Below: English armillary sphere, circa 1730.*

Namara, former defense secretary of the United States and now head of the World Bank, who is one of the leaders of the so-called peace movement in the United States, also has a peculiar relationship with the heavenly bodies: He reportedly belongs to a cult of individuals who go out into the woods on the day of a full moon and bathe themselves, naked, in the moonbeams. And in U.S. bookstores, the section on the "occult" and "astrology" is now three times as large as the science section.

Do you think this is harmless nonsense? What would you think if your doctor were consulting the stars to determine whether or not to remove your appendix? Or would you feel safe if you knew that NATO military deployments were planned according to the phases of the Moon and Venus?

I am sure many of you have occasionally looked up from your morning paper and exclaimed: "What is going on here? Is the world going insane?"

Indeed, in a precise sense the world *is* going insane. It is going insane because of the age-old oligarchical families who have long declared war on reason in order to secure their arbitrary rule over a brutalized and ignorant mass. Unfortunately, they are winning. The oligarchical program, their declaration of war, has now come out in the open: It is called the "Age of Aquarius." It means, as Marilyn Ferguson declares in her book *The Aquarian Conspiracy*,<sup>1</sup> the end of rationality in a great epidemic of kookery. If this conspiracy succeeds, then this may mean the end of mankind. As humanists interested in a future for the human race, we must defeat the Aquarian Conspiracy.

In the fight against oligarchism and kookery, our weapon is science. If we are to have republican nations, if the populations of these nations are to determine what policies these nations must follow, according to their own interest, then those populations must be educated to be able to determine what is right and what is wrong, what is reality and what is illusion, fantasy, or swindle. Reality, however—"right" and "wrong"—is not determined by the mere opinions of parents, teachers, friends, religious leaders, or the latest copy of the *New York Times*. All of these might be fatally wrong; they might already be hooked on astrological kookery.

#### Science Versus the Aquarian Conspiracy

"Right" and "wrong" are a question of scientific method, a question of how each person can seek the truth without having to accept blindly whatever belief or prejudice his or her friends or society might wish to enforce. If we are going to save the world from the Aquarian Conspiracy, we must know what reality is, how to find the truth. More important, we must be able to impart the scientific method to the population around us, so they can discover reality themselves.

The foundation of scientific method is astronomy—the basic question about how the universe as a whole is organized. You may be astonished by this. You may ask, "Do you mean I must know about planetary motions in order to run my business? Aren't you getting into the astrology you were just warning us about? What do the stars have to do with problems here on Earth?"

I will tell you a secret: Whether you realize it or not, every

thought an individual has, every opinion and every judgment, is based on certain assumptions embedded in his or her mind concerning how the universe functions, how it was created, and what its fundamental laws are. For many people, these ideas take the form of *religion*; more generally they are embedded in the *culture* of every society. Some people might say, "It doesn't matter how the universe functions; it obviously doesn't make any difference to me how the planets revolve." Such persons are simply asserting that the universe was built to satisfy their infantile desires—this is their hypothesis, a very unscientific one. Such people change their views only when something falls from the sky and hits them on the head.

Throughout history, there have been two main cultural tendencies, one oriented toward science and one oriented toward magic. Therefore, we can talk about two basic forms of culture: astronomical culture and astrological culture, which are also known as *humanist culture* and *oligarchical culture*, respectively.

There have been more than 40,000 years of battle between astronomical and astrological cultures, the battle for scientific method against superstition and magic. I will use the most elementary questions of astronomy—how our solar system is organized—to illustrate and distinguish between the scientific and the oligarchical methods down through the ages up to today.

The firsthand report below on the astronomical accomplishments of pre-Vedic astronomers, around 40,000 B.C., indicates how the basic astronomical questions were treated by early civilization and the early oligarchical enemies of scientific culture. These same ideas and method underlie the later breakthroughs of the greatest astronomer of more recent times, Johannes Kepler. In contrast, Galileo, Descartes, and Newton—far from being the great protagonists of science advertised in popularized myths—actually opposed the scientific method of Kepler and opened the way for modern versions of astrological cultism.

The Aquarian conspirators of today are merely carrying on the tradition of pseudoscientific kookery in cooking up the myth of the "Big Bang" and quarks on the model of the old Egyptian cult of Isis and Osiris. Fortunately, there has been recent work on a new hypothesis concerning the early development of the solar system. This hypothesis, conceived by Fusion Energy Foundation board member Lyndon H. LaRouche, Jr., shows the scientific method in action today, at the forefront of fusion energy, astrophysics, and atomic physics, applied to a very simple and fundamental question: Where did the Earth and the planets come from?<sup>2</sup>

#### Astronomy 40,000 Years Ago: A Firsthand Report

The following is a report from one of the most illustrious pre-Vedic astronomers, from around the year 40,000 B.C., on the great astronomical accomplishments of his day. Admittedly, this report was not found by archaeologists digging around somewhere; it originated in the general vicinity of my typewriter. However, perhaps it is not entirely unrealistic. (The interested reader is referred, among other sources, to the works of the great Indian scholar Tilak for relevant historical evidence on the advanced astronomy of the pre-Vedic period.<sup>3</sup>)

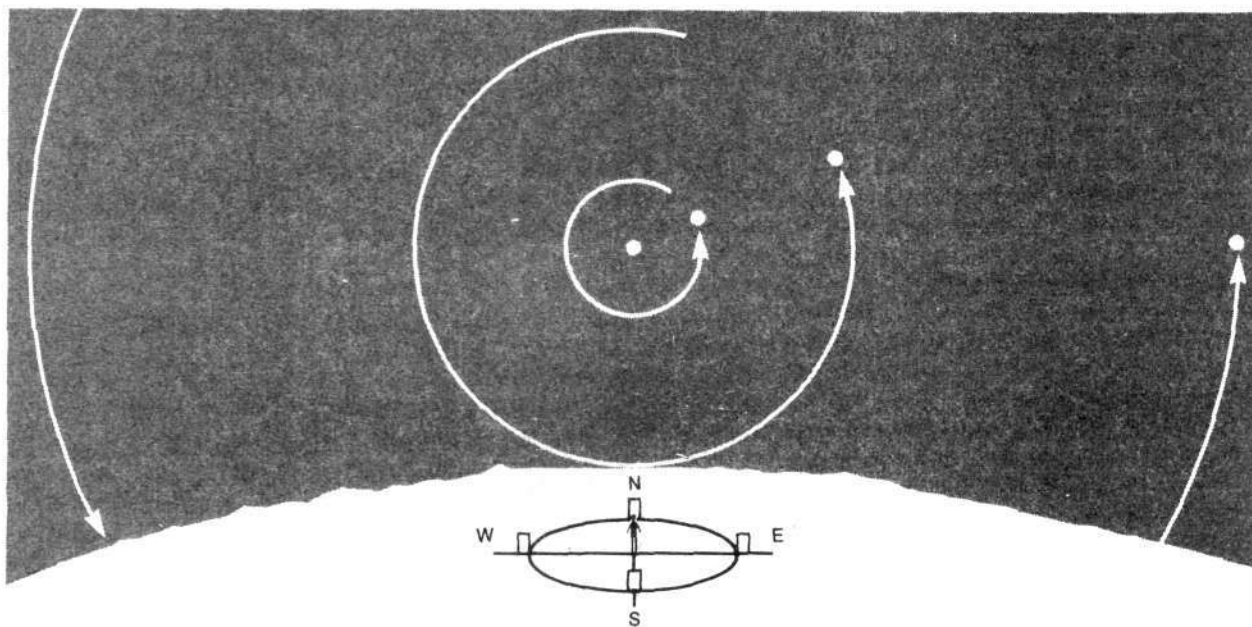

Figure 1

#### DETERMINING THE POINTS OF THE COMPASS

*The ancient astronomer describes how cities are planned around an observatory located at a point where the horizon is visible in all directions. East and west are then located at points where stars rise and set exactly opposite to each other in relation to the observatory. North is located at the point where some stars (such as the pole star) just barely touch the horizon at their lowest point.*

Now, we do not know exactly who the earliest astronomers were, nor exactly how far and in what way they developed their knowledge about the heavens. We do know that they developed astronomical calendars—methods of measuring time and mapping events on the basis of astronomical cycles—that reveal a very high level of scientific method compared with that applied even in the technical sciences of today.

In addition to what we can learn from old documents and traditions, our own comprehension of scientific method gives us a second, most necessary way to construct a picture of the ancient astronomy. Namely, we can place ourselves in the shoes of the ancient astronomers and ask, "What would we have done? What could we have done, without any of the modern instruments, without any prior knowledge, from scratch, to develop a scientific astronomy?" Then, we can compare what we come up with to archaeological and other historical evidence to arrive at a reasonable estimate of what ancient advanced astronomy must have been.

Here then is the report of the ancient astronomer.

\* \* \*

"My nation is a nation of seafarers and city-builders. We have colonized vast regions of the world, braving the seas and oceans with our ships and establishing new cities far and wide. We live by fishing in the rich waters of the sea and the mouths of the great rivers. We have invested our wealth and leisure in developing the inland areas, where we have established some plantations. It may surprise you that we, more than 40,000 years in your past, can easily

navigate across the oceans. Actually, it is easy if one knows astronomy as well as we do. You don't need any complicated instruments, just a good pair of eyes.

"Although we do possess a written language, it may surprise you that we use written records much less than your culture or the oppressive, bureaucratic hierarchy of Babylon, which your historians claim to be the forerunner of modern civilization. Instead, we compose and sing beautiful poetry, and by this method pass down our knowledge and history from generation to generation, without change, over thousands of years. Our ancestors for this purpose gave names to groups of stars and invented funny little stories about them to help remember them. So, we have precise astronomical records from thousands of years back, in the form of astronomical songs. . . .

"Let me explain how we plan our cities (Figure 1). We choose a high point, where the horizon is everywhere visible. We mark the point with a large stone. It will be the center of our city. Now, we watch the motion of the stars from this point. This is especially easy in those regions that are dark for half the year (which you call the polar regions). Otherwise, the Sun interferes with observation. Actually, we know how to observe the stars even during sunlight periods. (Guess how!)

"In any case, there are some stars that rise at some point on the horizon and disappear again at some other point. For the most prominent stars that rise and set we place stone markers as far as possible from our center to mark the points on the horizon. Some other stars never set, but just turn around in the heavens. And there are some very special stars that just barely touch the horizon at their low-

est point. This point we mark with a special stone; it is the same for all stars of this special sort. We call this the 'north' direction. The opposite direction we call 'south.'

"Another special set of stars rises and sets at points exactly opposite each other with relation to our observation point. We mark these points also with special stones; the rising point we call 'east' and the setting point 'west.' Now we build two roads through our center point, running east-west and north-south. At the center we make a central square, and in the middle of this square an astronomical observatory, around which we build the rest of our city. You may ask, why do we use the stars to mark out and construct the foundations of our city? This observatory has the work of organizing the calendars, predicting the weather and change of seasons, the tides and movements of fish and other creatures. It shall also be the center of education for our youth, a center for the history and archives of our nation.

"All the stars, with the exception of those you call the Sun and planets, move together, in circles or parts of circles, and they always return to their original positions at the same moment. I call this stellar cycle a 'day.' But I want to know more: I want to know where each day belongs in the history of the universe. I want to find longer cycles within which each day finds its individual place. We think of this as 'navigating in time.' With the help of these longer cycles I can construct a map of the history of the creation of the universe, which I call a calendar.

#### The Development of a Calendar

"Now, different cultures construct calendars according to different principles. Some peoples base their calendars on the motions of the Moon, which they imagine to be very important. (We call such people 'lunatics.')

Others use Venus. Some use just the Sun, and still others try to fit various cycles together into a single 'great year,' which is a very interesting problem.

"As for my culture, we keep developing our calendar, trying always to find the longest possible astronomical cycle as its basis. This is because we believe that the shorter cycles are always derived from the longest by division. So, we always measure time in terms of division of cycles.

"But, by what principle must we determine the manner of division? On what appropriate and lawful division is a day or a year based? We decide to take the circle, which represents a cycle, as a foundation along with the simplest polygons that can be constructed in a circle: the triangle, the square, the pentagon, and the hexagon. All these divide a circle into segments that we call 'periods' (Figure 2a). A square divides the circle into four segments, a pentagon into five, and so on.

"Each of these segments we can represent as a smaller circle, dividing it again with another polygon. Thus, for example, using a triangle, we can divide the original circle into three segments and then, using the square, divide each of these three arcs again into four segments (Figure 2b). This produces a division into 12 segments, which has been used by many peoples for division of the year—especially since  $1/12$  of the year approximates the cycle of the moon.

"Other divisions are also familiar:

"Square and hexagon: 24 parts, used by some to divide the day into hours.

"Triangle, square, and pentagon: 60 parts, used by some to divide the hour into minutes and the minute into seconds.

"Triangle, square, pentagon, and hexagon: 360 parts, as a rule used to divide any circle into 360 parts for the purpose of measurement of angles.

"So, first, my predecessors looked for the cycles of the Sun. They observed that contrary to the other stars, the Sun does not rise and set at the same place; the rising place slowly shifts from the eastern point toward the north, reaches a farthest point, and returns, passing through the east point and shifting to the south. And this movement determines the season: at the northernmost point, it is summer, at the southernmost rising point it is winter. This is easy to understand, since the Earth gets its light from the

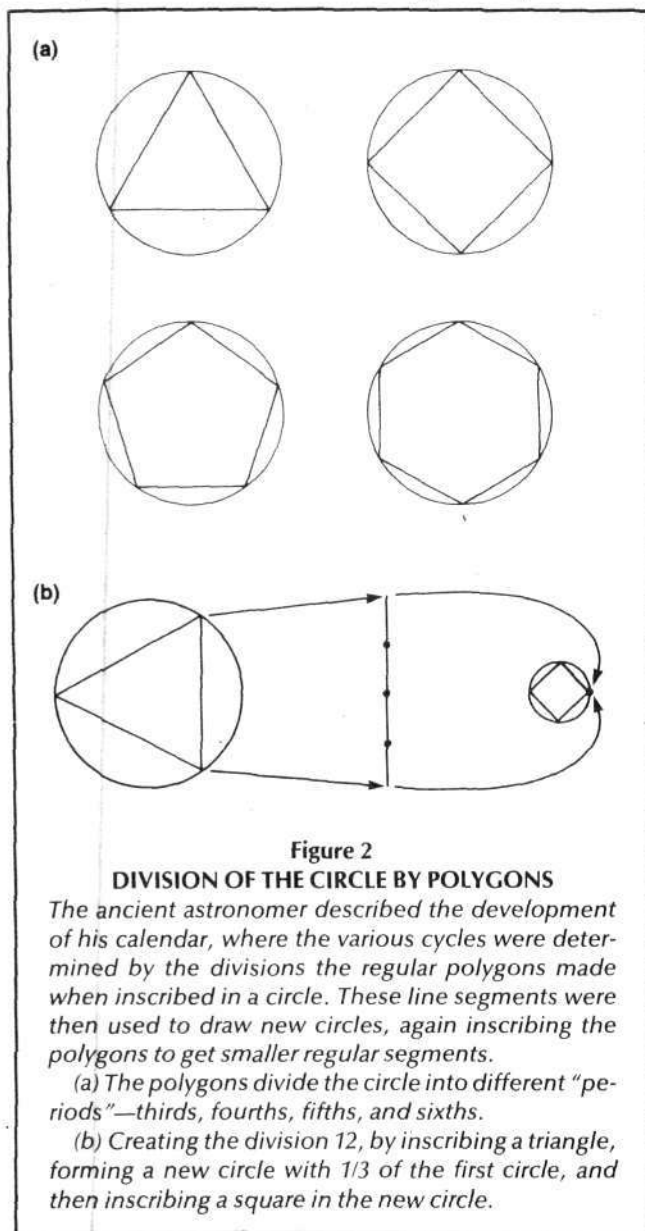

Figure 2

#### DIVISION OF THE CIRCLE BY POLYGONS

The ancient astronomer described the development of his calendar, where the various cycles were determined by the divisions the regular polygons made when inscribed in a circle. These line segments were then used to draw new circles, again inscribing the polygons to get smaller regular segments.

(a) The polygons divide the circle into different "periods"—thirds, fourths, fifths, and sixths.

(b) Creating the division 12, by inscribing a triangle, forming a new circle with  $1/3$  of the first circle, and then inscribing a square in the new circle.

Sun, and the northernmost position is at the same time the position in which the Sun's path is the longest. In the northernmost regions of our world, the Sun actually rises completely above the horizon in summer, and never goes down again until fall!

"Of course, it is not good to look directly at the Sun. Long ago, someone found a way to map the Sun's motion without having to look at it. They simply placed a stick in the ground, and watched the shadow. But, the astronomers of my nation regard this as an incorrect and misleading method. For we argue that it is wrong to represent motion in the universe on a flat surface, except when there is no other choice. For, the flat surface is not closed on itself, and can only be

made closed by adding a boundary of the universe, whose choice would be arbitrary, whereas all the motions are closed by themselves.

### The Spherical Solar Observatory

"So one very smart fellow conceived of marking the shadow of the Sun on the surface of a *sphere*, which is closed and complete and is its own boundary! In fact, he pointed out that if we stand on top of our observatory and point an arm in various directions, then our hand moves around on a sphere, whose center is at our shoulder. The sphere is thus a good choice for a map. By the way, in case you didn't realize it, your own eyes function by spherical projection. Just look at the retina of the eye, which is a spherical surface!

"In Figure 3a you see the plan of my spherical solar observatory; the shadow is cast by a small sphere suspended at the midpoint of the sphere. Of course, we can only project if we leave away the upper portion of our sphere; then, the equator corresponds to the horizon. Figure 3b, by the way, is a photograph of a similar instrument made much later by the Greeks. Now I can trace the path of the shadow throughout the year!

"Now maybe you know what the result of these observations is: each day, the image of the Sun describes a part of a circle on the sphere; but this circle shifts slowly, always parallel to itself. In Figure 3a I have marked the two extreme circles, corresponding to northernmost and southernmost settings of the Sun, known as the solstices. In between these circles is a third, half of an equator, that occurs two times in the year when the Sun rises exactly in the east and sets exactly in the west. These you call the *equinoxes*.

"We argued that if some of the stars always stay above the horizon, making full circles of motions, and if also in the northern regions in summer the Sun itself makes full circles above the horizon, then why not imagine that the actual daily motion of the Sun is a full circle, part of which is just hidden from us underneath the horizon after the Sun goes down? So, some very wise astronomer decided to add an upper hemisphere to the lower hemisphere, and to complete the daily circles of the Sun by means of curves traced on the upper sphere! Of course, to see them we trace the curves on the outside of the sphere. So, these curves above represent an imaginary projection of the Sun, for its motion below the horizon during the night. You see, by using this hypothesis we have a beautiful and simple theory.

"Of course, some people got very angry about this spherical map. They objected, 'Who has ever seen the Sun at night?' They call this idea crazy and impractical. But I answer: if our world were transparent, then we *would* see the Sun shining beneath our feet after sunset! They just say, 'If you can't see it, then you can't talk about it!'

### The Method of Hypothesis

"You see, we use the geometrical method of hypothesis. Our spherical mapping is hypothesis: It is not a *model* of the universe, in the sense that the degenerate systems analysts of your culture understand 'model.' It is, rather, an image-concept upon which the data of our senses (our observations) can be mapped in such a way as to permit us to

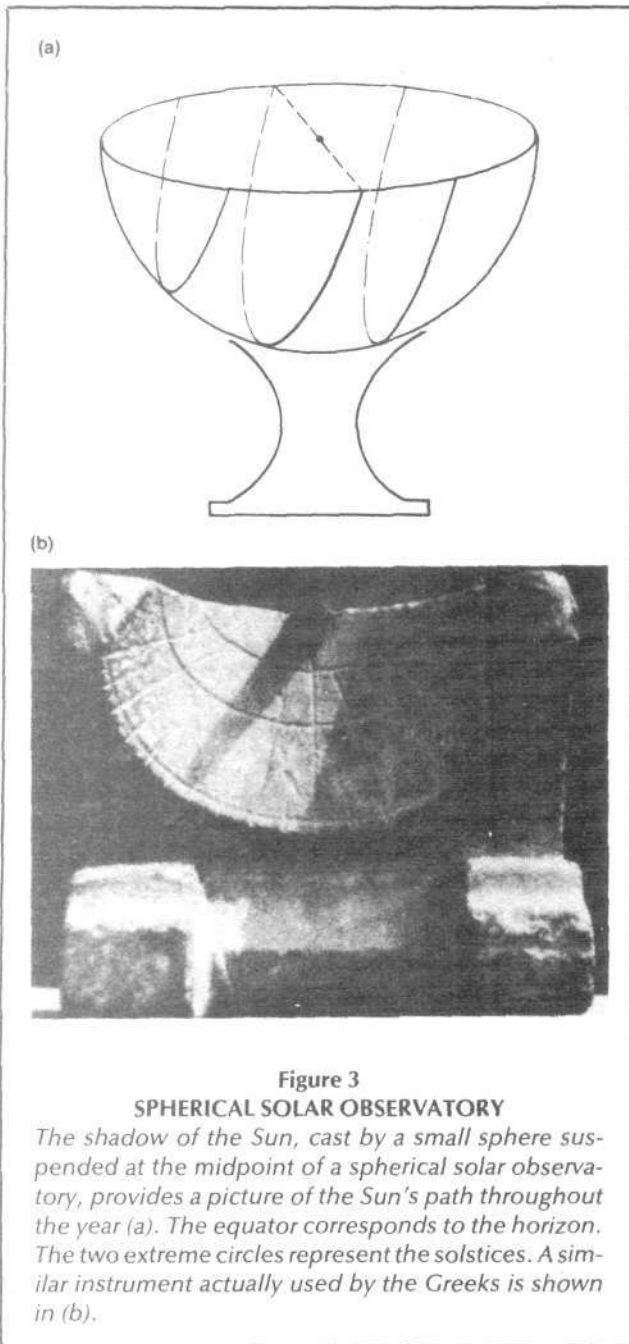
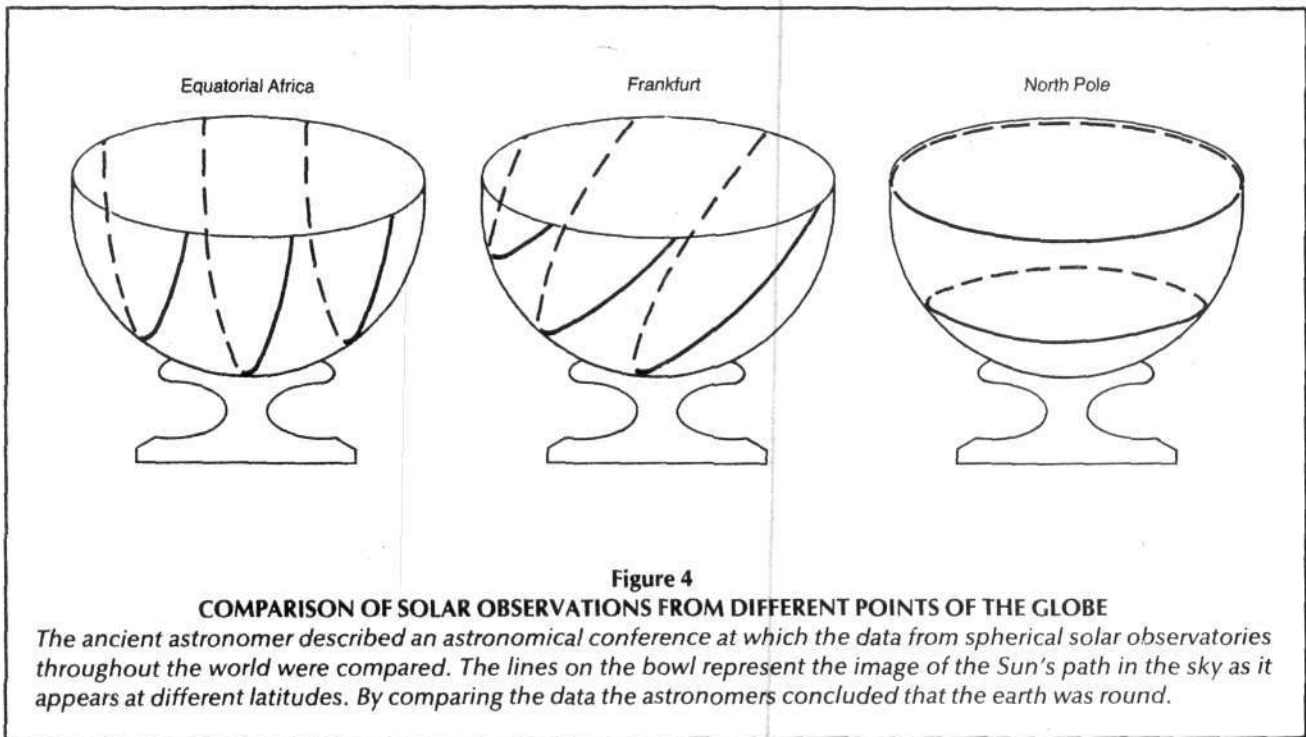

Figure 3

### SPHERICAL SOLAR OBSERVATORY

The shadow of the Sun, cast by a small sphere suspended at the midpoint of a spherical solar observatory, provides a picture of the Sun's path throughout the year (a). The equator corresponds to the horizon. The two extreme circles represent the solstices. A similar instrument actually used by the Greeks is shown in (b).



transcend the limits of the 'here and now' of sense-certainty, and look at the universe, so to speak, 'from the outside.' With our method of hypothesis we exercise exactly those divine capabilities of mind that distinguish us from the animals. For, no animal can ever 'step outside' the here and now to examine processes as a whole.

"My predecessors set up observatories like this in many, many cities. Then, at periodic intervals the spheres were brought to a single place, where they made an *astronomical conference*, and compared them. Figure 4 is a drawing showing their spheres brought from various parts of our world (Central Africa; Frankfurt, Germany; and the North Pole). They found a very interesting thing: everywhere, the sphere rotates relative to the horizon, until at the North Pole itself (where there is actually no northward direction), the horizon coincides with the planes of all the circles. Since the motion of traveling upon the Earth corresponded to rotating the sphere, they concluded that the Earth must also correspond to a rotation, that is, *the Earth must be round!* Actually, all wise men have always throughout history immediately known that our world is spherical.

"This coincidence of spherical mappings made a big impression on everybody. We immediately recognized that a single spherical mapping suffices to completely represent the daily motions of the stars; from any position in our world. Our map, shown in Figure 5, we call an *armillary sphere*. We have marked the relative positions of all the stars on the rotating sphere. The outer, circular disk represents the horizon. As we rotate the sphere around the axis you see a representation of how the stars rise in the east and set in the west. The equator or largest parallel circle on the globe determines the positions of those stars that rise and set in the exact east and west. This you call the *celestial equator*. To determine the appearance of the heav-

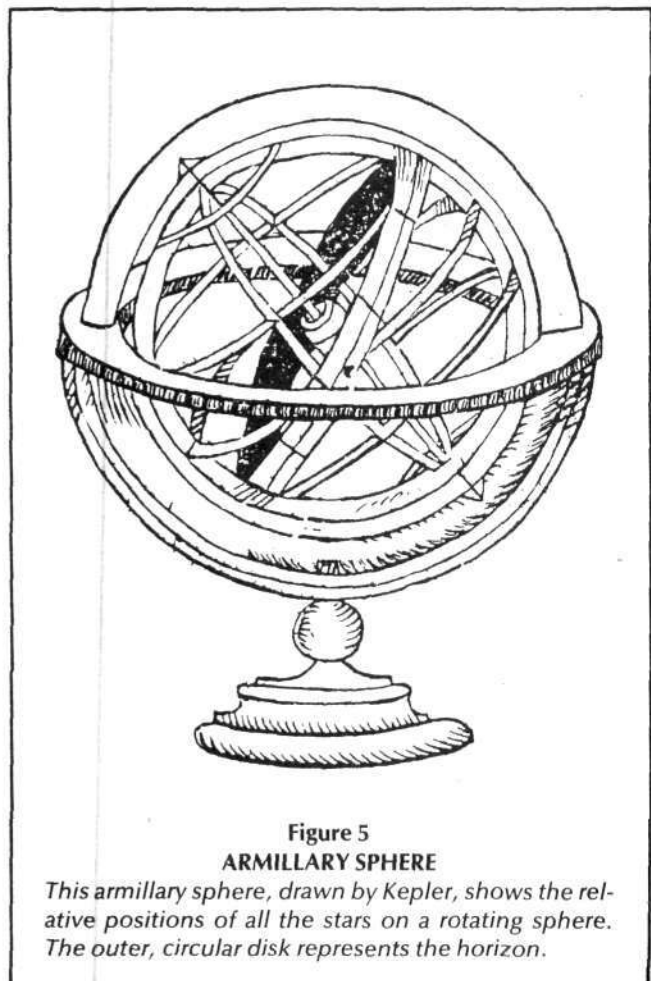

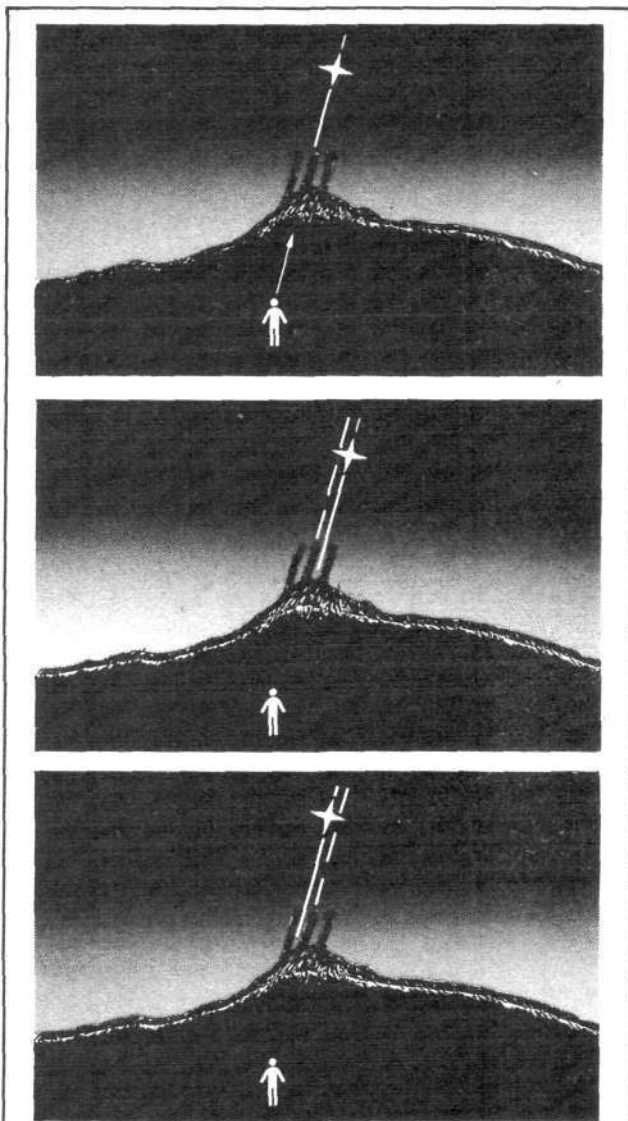

**Figure 6**  
**METHOD FOR OBSERVING**  
**THE SHIFT OF THE EQUINOX**

*By placing large carved stones atop a distant mountain as a reference point, the ancient astronomer explained, he was able over the course of a few years to measure very small changes in the rising and the setting of the stars. This was the basis for determining the shift of the equinoxes along the ecliptic.*

ens in any place on the Earth, we have merely to shift the position of the axis of the sphere according to the angle determined by the local solar observatory.

#### Mapping the Sun's Movement

"With this excellent mapping instrument, we could next tackle the question of the movement of the Sun. Someone got the wonderful idea that for this purpose it was enough simply to observe the regions of the stars in which the Sun was located at different times; in other words, we need not

worry about the daily motion since it is already represented by the rotation of the sphere. Now, how can you tell where the Sun is located, when its light obviously is extinguishing that of the stars in the vicinity? I won't tell you the answer! It's really very easy once you have put together a good spherical map such as we have done. Now we can, so to speak, 'stand outside' the daily motions, and look at the motions from the standpoint of the sphere of the stars as fixed.

"What do we find for the Sun?

"Another wonderful discovery! The Sun describes, very slowly and in the course of a full year, a complete, great circle through the sphere of the stars—the circle that our Greek successors named the *ecliptic*. In Figure 5 you can see it fixed upon our spherical astrolabe.

"Now everything becomes clear. As the Sun moves slowly along the ecliptic, the result of the daily rotations around the polar axis is to run the Sun around circles of changing radius, resulting in the circles we had earlier observed for winter, summer, spring, and fall. Now we can see why the days are longer in summer than in winter: because the portion of the daily circle that runs above the horizon is longer. We also see that when the Sun reaches one of the two points of intersection with the celestial equator, then the Sun that time will rise in the exact east and set in the exact west. This will be a time when day and night are exactly the same length—the so-called equinox. There are two such points—the spring equinox and the fall equinox.

"This discovery of the motion of the Sun along the ecliptic circle caused a great scientific controversy. For, now there seemed to be two completely different modes of action in the universe—the rotation of the whole celestial sphere around the axis of the North Pole, and the rotation revealed by the Sun's motion, a rotation around the axis perpendicular to the plane of the ecliptic. Some people just shrugged their shoulders and said, 'Why not?'

"But the wisest men insisted that there could be only one, unified mode of action in the universe, and hypothesized that the celestial and ecliptic rotations must be somehow linked together and subsumed under a common principle. They said, 'Watch the equinox points, for these are the singularities,' thinking that the relation between the two rotations must be revealed through the points at which the corresponding circles (celestial equator and ecliptic) intersect.

"And, indeed, ancient tradition, handed down for several millennia in our ancestors' astronomical poetry, told us two things. First, the path of the Sun through the stars remains almost exactly the same from century to century; the ecliptic changes very slowly, if at all. But, our forefathers, who were always careful to note the positions of the equinoxes, tell us that many centuries ago, the stars that are now found at the equinoxes were displaced, and instead *other stars* occupied those singular points.

"We therefore decided to make a very precise series of observations, and for this purpose devised a new technique, using carved stones placed atop a distant mountain as reference points for measuring very small changes in the trajectories of the stars. In fact, we were able to measure displacements of less than a hundredth part of a degree.



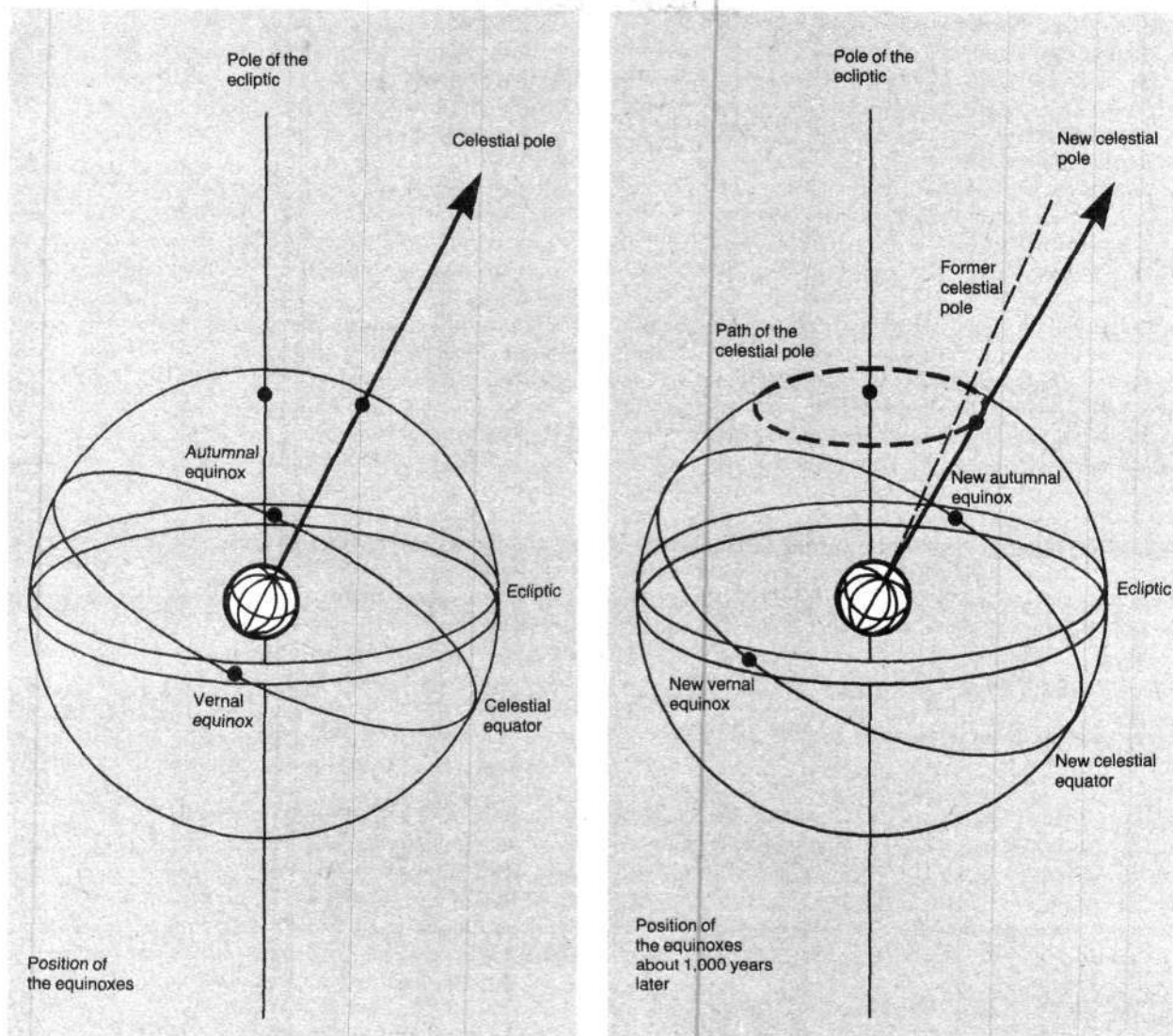

**Figure 7**  
**SHIFT OF THE EQUINOX OVER 1,000 YEARS**

Extensive observations confirmed that the axis of celestial rotation is itself rotating around the axis of the ecliptic, in what is called the precession of the equinoxes. In 26,000 years, the axis of the ecliptic makes a complete rotation around the celestial axis.

"We found that in the course of a few years, the stars that formerly were at the fall equinox were no longer rising exactly in the east, but had now shifted slightly to the north (Figure 6). At the same time, the stars belonging to the region of the spring equinox were now rising to the south of the exact eastward point. We made a daring hypothesis: we guessed that the entire celestial equator is moving, rotating relative to the ecliptic circle, in such a way that the points of intersection, the equinoxes, are shifting along the ecliptic.

#### The Precession of the Equinoxes

"Extensive observations confirmed this hypothesis com-

pletely. This is the motion your astronomers call the *precession of the equinoxes*. What is happening is that the axis of the celestial rotation is itself rotating—around the axis of the ecliptic! In other words, we have a 'rotation of a rotation!' (See Figure 7.)

"Many people find this a very abstract and obscure idea. But we astronomers are delighted, because it completely resolves the paradox of the two modes of action in the universe. For, the 'orbit' of the celestial equator around the ecliptic axis proves that *the ecliptic rotation is primary*. Everything—the whole universe—is organized around the rotational axis of the ecliptic! At least, this was our hypothesis. We found further proofs of this: the paths of the Moon and

the other planets all lie very close to the ecliptic. Furthermore, the circle of the Moon's orbit, like the celestial equator, also precesses around the ecliptic.

"A final, very beautiful proof came from our observation of the Sun. During some years and months you can actually see some dark spots on the Sun's surface, when you observe it just at dawn or sunset. We found that in the course of about 12 days, these spots drift from one side of the Sun's disk to the other, along a line oriented exactly along the ecliptic direction! So, we concluded that the Sun itself is rotating, and that the axis of the Sun coincides with the axis of the ecliptic.

"Incidentally, our measurement of the shifts in position of the equinoxes shows that a complete cycle takes about 26,000 years! That is, in 26,000 years the axis of the ecliptic makes a complete rotation around the celestial axis, and the same stars as today occupy the positions of the two equinoxes.

"We make it a practice in our educational system to have our children work out the measurement of the equinox cycle themselves, as a tremendous proof of the lawfulness of the universe and the power of the human mind to comprehend that lawfulness. Also, the idea that a process exists in the universe that requires 26,000 years to complete gives our young people a remarkable notion of *history*. Rather than just living in the egoistic prison of the 'here and now' like your youth, our young people see their lives as part of the great drama of the creative enfolding of the universe.

### The Spiral Hypothesis

"Now I want to close by reporting the most remarkable and exciting discoveries made just recently (that is, 40,000 years ago to you). I said that the rotation associated with the ecliptic seems to be the primary one. I should have said 'the axis of rotation,' because, in fact, we find different

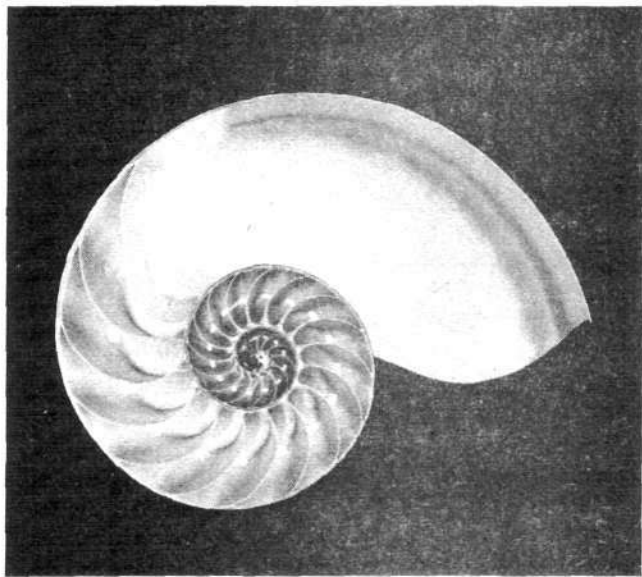

Carlos de Hoyos

"Of all living beings, the snail shell is the simplest and most characteristic in its growth." Shown is the chambered nautilus.

lengths and speeds of various cycles for different phenomena, although all can be related to this axis. So, we have the year, and the precession of the equinoxes, the periods of the planets, the period of the Moon, and even the cycles of that strange object which you call Halley's Comet, which also moves close to the ecliptic and seems to return about every 76 years.

"We decided to look for a new hypothesis, a new way of mapping these cycles. One of my friends got an idea when he saw a whirlpool in water—where all parts rotate around a center, but the closer parts move slower, the ones farther out move faster. Then, in discussion, we decided in favor of a similar but different model—a snail shell whose windings are closer near the center but grow wider in constant proportion farther out. I proposed to use such a spiral shell to map the various cycle lengths, since I believe the universe is constantly developing like a living being, and of all living beings the snail shell is the simplest and most characteristic in its growth. Therefore, we took the snail shell as our higher hypothesis and decided for the moment to forget about the spherical model, and just map the cycle times of various cycles onto the shell.

"So, I took some point on the spiral as my base point, to represent one year (Figure 8). Say, I use the distance from the center of the cone to represent the length of cycles. Then, since the cycle or year of Mars is a little less than twice that of the Earth, that is, a little less than two years, I move along the spiral until I find the point whose distance is a little less than twice the distance for the starting point. For the planets Mercury and Venus, which have shorter periods, I have to go up the spiral toward the center. In any case, if I map the cycles of the planets in this way, I find that from the point representing the Earth, Mars requires about one rotation around the spiral, Jupiter requires five, and Saturn requires seven. To get the point for Venus, I must go back one rotation. To get to Mercury I need three, and to get to the period of the Moon (one month) I need five.

"As you see, just about exactly a whole number of rotations separates the points for any two planets! It seems that there is a gap between Mars and Jupiter, where we might expect from the pattern a planet at three rotations down from the base point; in fact, I understand you modern people have actually found, not one, but a whole group of planets with the corresponding period, which you call the asteroids or little planets.

"You might be amazed that practically all the other cycles known to us map very well to our spiral hypothesis. For example, the precession of the equinoxes corresponds to almost exactly 21 rotations (of course, I would need a gigantic shell to go around that far; I can tell you this because I have deduced it from the law of the spiral). Halley's Comet is almost exactly at 14 rotations, and the cycle of eclipses, which I didn't talk about, but which is about  $18 \frac{1}{3}$  years, corresponds to exactly six rotations. If you check, you will find the same thing for some of the cycles better known to you today, such as the periods of Uranus, Neptune, and for the galactic rotation (almost exactly 30 rotations). It may surprise you to know that we already knew about the galactic cycle in my time.

"Now, I don't want to give you the idea that everything is

perfect in my nation. In fact, the astronomical method has already been destroyed in many parts of the world by a strange group of individuals who call themselves 'priests,' 'seers,' and 'magicians.' They go around saying that this sphere upon which we were mapping the universe *really exists* up there in the sky! Furthermore, they go around telling people that those wonderful, imaginative stories and fables that we used to help us remember the positions and movements of the stars are actually true—that the stars are dangerous gods whose battles can make one man happy and destroy another.

"They don't tell anyone about our marvelous spiral-growth hypothesis, which shows how even the smallest living creature is similar to the universe, but instead, they say that the heavens and the Earth are ruled by completely different laws. Some of these priests say that the heavens are fixed and eternal, but the Earth is evil and corrupt, and they tell people to forget about improving their lives and prepare to die, so they can get to heaven as soon as possible. Others say that both heaven and Earth are chaotic and without order. But all these priests try to get power and influence by scaring people. Every time some disaster happens, they correlate this with the motion of some star or planet and say the disaster was caused because people failed to propitiate the god. This is pure random correlation, but some people fall for it.

"In many cities now these priests have taken over the observatory and turned it into a temple for sacrifices and strange rituals. They have hidden all the astronomical instruments and do not permit anyone else to use them, so they build themselves up as the sole experts and authorities in these matters. Also they have invented strange, secret symbol languages and writing, to mystify everybody (something like your algebra).

"When they have succeeded in making everybody ignorant and fearful, then they force them to start worshipping the 'Great Mother'—they say that if you do not make sacrifices and propitiate the Great Mother and all the other gods every day, and do what the priests say and give them food and gold, then something terrible will happen. They also say that the Earth is flat and that no one should venture far from the coast in ships. Anyway, once astronomy has been forgotten, no one will know how to navigate anymore, so it really will be dangerous. You see what they are trying to do to us."

*Jonathan Tennenbaum, a mathematician, is director of the Fusion Energy Foundation in Europe and editor-in-chief of the German-language Fusion. This article is adapted from a speech he gave in 1984 at a European conference of the International Caucus of Labor Committees.*

#### Notes

1. Marilyn Ferguson, *The Aquarian Conspiracy: Personal and Social Transformation in the 1980s* (Los Angeles: J.P. Tarcher, 1980).
2. Lyndon H. LaRouche, Jr., *The Present Scientific Implications of Vedic Calendars from the Standpoint of Kepler and Circles of Gauss* (New York: Fusion Energy Foundation, 1984).
3. Bal Gangadhar Tilak, *Orion and The Arctic Home*, Poona, India, reprint 1958.

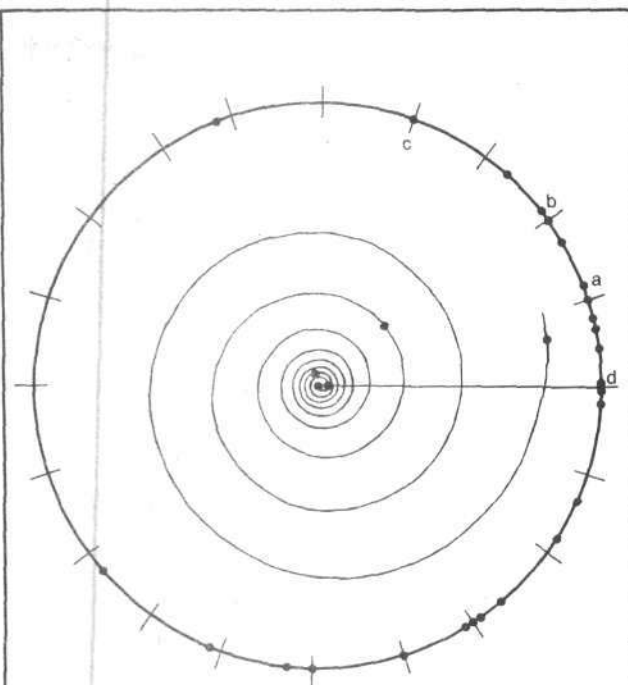

- a = Galactic cycle of the Sun (234 million years)
- b = Precession of the equinox (25,800 years)
- c = Period of Revolution of Uranus (84 years)
- d = Period of Halley's Comet (76 years)

**Figure 8**  
**MAPPING OF THE ASTRONOMICAL CYCLES**  
**ONTO A SPIRAL**

*This self-similar (logarithmic) spiral expands according to the golden section:*

$$k = \frac{1}{2}(1 + \sqrt{5}) \sim 1.618$$

*Every astronomical cycle corresponds to a point on the spiral, whose radial distance from the center is proportional to the length of the cycle. An arbitrarily chosen point represents the period of the Earth (one year) and forms the unit for the radial distance. The point nearest the midpoint corresponds to an Earth year, followed by Mars, and a series of marks for the different periods of the asteroids, Jupiter, and Saturn.*

*If longer cycles are to be represented—for example, the galactic cycle (234 million years)—the spiral must be expanded on a gigantic scale. These cycles can nonetheless be projected onto the outer circle, in order to give the direction in which the corresponding points of the different cycles—seen from the midpoint—would lie if they were inscribed on the spiral.*

*The cycles group themselves in the region of the general directions that correspond to the Earth year and the galactic cycle. This means that virtually all the cycles are distinguished from those two through approximately whole-number powers of the golden section.*

A Mexican astronomer has extended Kepler's method to relate the mass and spin of astronomical objects over 40 orders of magnitude.

# How the Universe Is Created

by Carol White

ALMOST 400 YEARS AGO, astronomer Johannes Kepler laid the basis for modern astronomy. Even though he is best known for his three laws of planetary motion, his primary interest was to develop a theory to account for the creation of the planets. While his work has not yet been qualitatively superseded, the Mexican astronomer Luis Carrasco has succeeded in extending its application to account for the formation of all observed astronomical structures in the universe.<sup>1</sup>

Carrasco and his collaborators have pulled together the otherwise disparate findings of a number of modern astronomers in order to demonstrate the fundamental importance of rotational action, in the form of angular momentum, to the process of forming what he calls astronomical objects. To do this he has extended Kepler's Third Law and applied it to a correlation between the mass and the angular momentum of a wide variety of these structures, from asteroids to galaxies. (Angular momentum is the product of the square of the radius of a rotating object and its angular frequency times its mass.) Kepler's Third Law states the invariance of the ratio between the arithmetic mean distance of a planet from the Sun at aphelion and at perihelion, taken to the 3/2 power, and the period of the planet's orbit (see Figure 1). This law can also be stated as an invariant ratio between the angular momentum squared of an orbiting planet and its mean distance from the Sun.

Carrasco has established a relationship between specific spin angular momentum and mass as a generalization of Kepler's Third Law, and he has applied this law to all astronomical objects observed in the universe. Kepler's Third Law states that

$$A_1^3 : T_1^2 = A_2^3 : T_2^2$$

*The "Whirlpool" spiral galaxy, NGC 5194, in Canes Venatici with its satellite galaxy, NGC 5195, photographed with the 200-inch Mt. Palomar telescope.*

Palomar Observatory Photograph

(where  $A$  is the arithmetic mean distance from the Sun and  $T$  is the period of the planet's orbit) and will be determined by the mass of the Sun. Carrasco's law equates the two-thirds power of the mass of a given "astronomical object" to its specific spin angular momentum. Specific angular momentum is the angular momentum per unit of mass of the rotating object. Specific spin angular momentum measures the daily rotation of the planets, the moment of inertia times the angular frequency per unit of mass.

Carrasco used the method of Karl Gauss (in which the mass of the astronomical object in question is treated as "smeared out" over the extent of its orbit) to develop the formula

$$M^{2/3} \sim J/M$$

(where  $J$  is the spin angular momentum), which he uses to relate the mass and momentum of astronomical objects. It should be noted that the extension of Kepler's Third Law to satellite bodies rotating about a central body establishes a relationship between the mass of the planet, for example, and that of the Sun. The ratio of the quantities  $A^{3/2} : T$  will be invariant but different in the case of planets rotating around the Sun, or moons rotating around a planet. It is equal to the ratio of the square root of the masses of the two central bodies.

(Actually, as Newton pointed out, this ratio will not be precise, because the mass of the rotating body must also be taken into consideration.)

Carrasco's main contribution to astronomy has been to

understand the significance of the work of a number of astronomers and to generalize their results into one theory. In 1967, the astronomer L.M. Ozernoy<sup>2</sup> discovered the correct law,  $M^{2/3} = j$  (where  $j$  equals specific spin angular momentum), applied to galaxies; and in 1970, the astronomer R.P. Kraft<sup>3</sup> applied it to the Sun. Similar studies have been made since 1963 by other astronomers, but none of these applied the correct power law over the whole range of astronomical objects—or in some cases, they did not recognize the correct power of the mass. The relationship between angular momentum and mass for a wide range of astronomical objects varying over 20 orders of magnitude was first noticed by the astronomer P. Brosche,<sup>4</sup> who, however, expressed it as a correlation between mass squared and spin.

#### Minimum Angular Momentum and Characteristic Density

Carrasco has studied the angular momentum of various astronomical objects over almost two decades. He began by studying the loss of angular momentum in the Sun as a by-product of solar flaring. Through the solar flare the Sun loses a certain amount of mass and also extends its magnetic field. It transfers momentum to the plasma gas disk that surrounds it and thereby brakes its own angular velocity. Carrasco became interested in the fact that astronomical objects seemed to be formed where angular momentum was at a minimum locally. He was attracted by the simplicity of a law that was nonetheless universal. As is well known, the angular momentum of a rotating body determines its stability. Therefore, for a star to form, for example, there is a maximum angular momentum that the star will tolerate. If the angular momentum of the gas from which the star is to be formed is too great, then centrifugal force will prevent the gas from ever condensing into a star.

The rate at which angular momentum is shed is reduced with time. Our own Sun is a good example of this. It would have been rotating at a far greater speed when it was first formed than now, and would have experienced a great deal more flaring. This process of solar flaring is important in understanding the evolution of stars. The prediction by Carrasco some years ago that high levels of solar flaring should be seen in the case of young stars has been confirmed experimentally by NASA's Einstein X-ray detecting satellite.

As the rotating gaseous disk from which a star is to be formed loses momentum, the disk contracts to a certain minimum density that is the characteristic density at which star formation takes place. The mass/spin law shows that characteristic densities exist throughout the universe for all types of astronomical objects—over 40 orders of magnitude—from asteroids to clusters of galaxies (see Figure 2 and Table 1). This characteristic density is a kind of least-action function, which allows the object to shed the barest amount of angular momentum necessary to guarantee stability. Although the object in question must shed angular momentum in order to achieve stability, the structure that is formed will be larger, the greater the angular momentum of the disk from which it was formed. At the point that the maximum tolerable angular momentum is reached, the object establishes an identity as star, galaxy, or what ever.

Carrasco has found that structure formation is quantized in narrow bands like the harmonic spacing of the planets, at points of lower angular momentum and greater cloud density, so that objects do not form at random. The only variation in the law is in the case of spiral galaxies, where the mass to the *three-fourths* power is related to specific spin angular momentum. Carrasco explains this variation in the power from two-thirds to three-fourths by the fact that a spiral galaxy is essentially two-dimensional rather than three-dimensional.

#### A New Look at the History of the Universe

Carrasco has discovered a new way of dating the formation of stellar mass. Galaxies, as such, are divided into two main categories—spiral galaxies like our own—and elliptical galaxies. The elliptical galaxies, ellipsoids with three different axes, are far more dense than spiral galaxies, yet they have less angular momentum than spiral galaxies by a factor of 20. It appears that elliptical galaxies had a higher efficiency for the removal of torque at the time of their formation than had spiral galaxies. They have already stopped the process of star formation. They have little surrounding gas left, and what there is, is ionized and therefore too "hot" to support continued star formation.

The formation of stars or planets from the gaseous nebula occurs as vortices are formed. The spin angular momentum is a function of the angular momentum of the disk out of which the planet is formed and the rate of change of the momentum over the area of the disk. Such vortices formed in a plasma will give rise to an electromagnetic field. Carrasco's work demonstrates that it is essential to integrate the field of plasma physics into the center of astronomy.

A great amount of work has been done establishing that an induced magnetic field will scale with angular velocity. In the presence of a stellar wind, even a moderately strong magnetic field will suffer large losses of angular momentum. Rotating stars can be expected to slow down when their stellar wind interacts with the surrounding convective envelope, as verified by astronomical observations in 1971 and 1983. As the angular velocity decreases, the magnetic field decreases, and as a consequence torque and stellar activity also decrease. Carrasco has found that after their formation all galaxies tend to lose angular momentum uniformly, as a function of time rather than of mass. It is this that allows us to treat them as quasirigid structures. The mass/momentum law operates as a step function, allowing us to date galaxies according to the amount of specific spin angular momentum that they have shed since their formation. This dating has been independently confirmed by other criteria.

Johannes Kepler attributed the force field between the Sun and the planets to magnetic action. Although the specific form of his hypothesis has obviously been superseded, the importance of the electromagnetic field has been largely overlooked by astronomers. Only recently has the work of plasma physicists been applied to astronomy, as it has been recognized that "space" is also a plasma, despite the disrepute of ether theories. Traditionally, cosmologists have ignored the importance of the electromagnetic field in the

Figure 1

**KEPLER'S THREE LAWS OF PLANETARY MOTION**

The physics contained in Kepler's three laws laid the basis for modern astronomy.

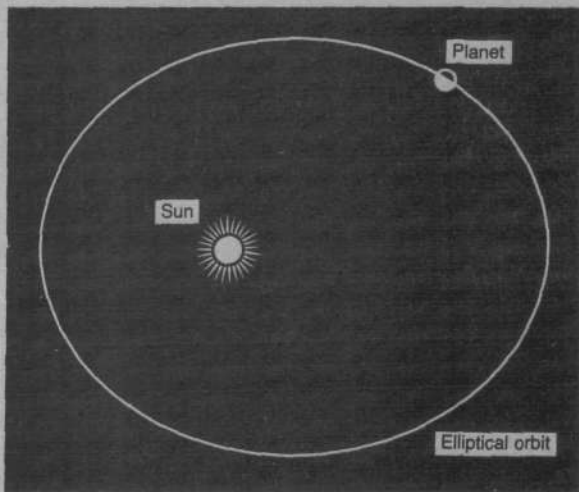

(a) Kepler's First Law

The orbit of a planet sweeps out an ellipse, with the Sun at one focus. Shown is a greatly exaggerated elliptical orbit (the orbits of the planets are actually within 1 percent of being circles).

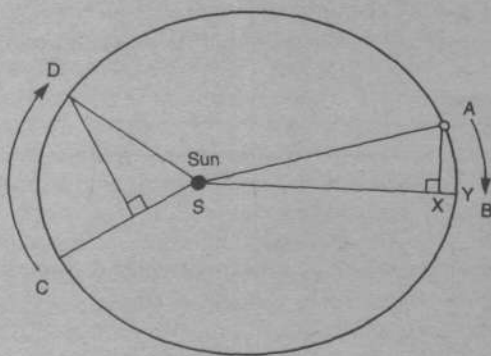

(b) Kepler's Second Law

A planet sweeps out equal areas in equal times, no matter how far it is from the Sun. The time it takes the planet to travel from A to B is the same as it takes to travel from C to D. The planet travels slightly faster between C and D to make up for the shorter distance between A and B.

Another way of stating this is that the rotational velocity at a certain point is inversely related to the radius at that point. The equal area law is also equivalent to the statement that without the addition of external forces, angular momentum  $h$  is conserved. The angular momentum at A equals the length SA times the circular velocity along the arc AY, a construction adapted from Leibniz.

Semilatus rectum of planet 1, SM

Semilatus rectum of planet 2, SN

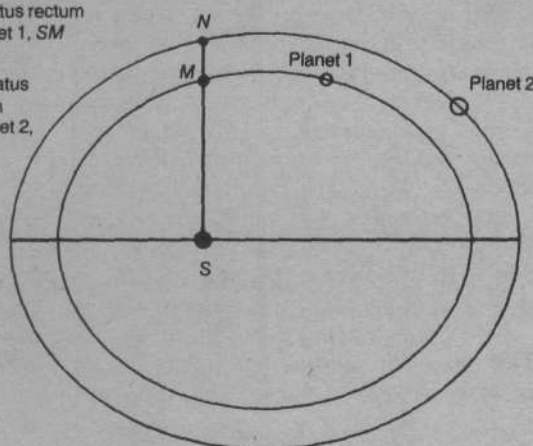

SM/SN is approximately equal to  $h_1^2/h_2^2$

Semilatus rectum, SM

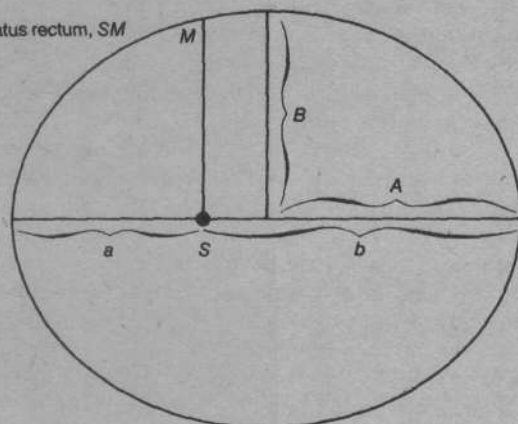

$$A = (a + b)/2$$

$$B = \sqrt{ab}$$

$$SM = B^2/A$$

$$\pi AB = \text{area of ellipse}$$

$$\pi AB/2h = T$$

$$\pi AB/2k (B/\sqrt{A}) = \pi/2k (A^{3/2}) = T$$

$$A^{3/2}/T = \pi/2k$$

(c) Kepler's Third Law

The Third Law says that the ratio of the cube of the distance of the planet from the Sun to the square of the time it takes the planet to go around the Sun is the same for every planet. This law holds also (with a different constant ratio) for the moons of Jupiter and Saturn.

Kepler's Third Law is derived from two relationships. First, the square of the angular momentum  $h$  of two planets is approximately proportional to the semilatus rectum, the radius perpendicular to the focus, of each planet. (We can overlook the small discrepancy introduced by the respective masses of the two planets.) Thus  $SM/SN$  is approximately equal to  $h_1^2/h_2^2$ .

Second, as shown in Kepler's Second Law, the orbital area a planet sweeps out equals  $\pi AB$ , where  $A$  is the semimajor axis and  $B$  is the semiminor axis of the elliptical orbit. Thus, we can divide this by twice the angular momentum,  $2h$ , to get the planetary year, or period, times some constant  $k$  that represents the Sun's mass and the gravity constant. However, the angular momentum  $h$  equals the semiminor axis  $B$  divided by the square root of the semimajor axis  $A$ . By algebraic substitution, we arrive at Kepler's Third Law:

$$A^3/T^2 = k.$$

evolution of the universe, treating the process of structure formation as an interplay between gravitational and centrifugal forces.

In 1958, the plasma physicist Winston Bostick correctly predicted that the plasmoids he had identified in a laboratory setting would be found in space by astronomers<sup>5</sup> (Figure 3). Although his work has been largely overlooked, Bostick's prediction has been amply confirmed with the identification of vortex filaments, such as the recent discovery by astronomers Mark Morris and others of an arc of parallel filaments near the core of the Milky Way Galaxy. This coheres with the discovery by Bostick of barred-spiral structures in his laboratory plasma-focus device. So far a mean magnetic field running in the same direction of the arm of a spiral galaxy has been detected, by studying radio polarization maps (Figure 4). It is extremely likely that some helical vortical structure will be discovered in these arms, similar to those seen in the laboratory plasmas by Bostick.

Carrasco has also determined that astronomical objects are formed at those places in which, locally, angular momentum is at a minimum. These local minima appear to occur in bands, which suggests the possibility that there are magnetic sheets that create different rates of rotation (see Figure 5). In 1979, it was shown by investigators that the time scales for magnetic transport of angular momentum in a typical interstellar cloud are extremely short—in astronomical terms, ranging between 100,000 and 1,000,000 years for the value of magnetic field strengths observed. In his latest work, Carrasco has studied mechanisms through which magnetic braking may cause stars to lose angular momentum over time. This is substantiated in a large volume of work that associates stellar activity, such as X-ray emission, with a star's angular velocity.

Carrasco's mass/momentum law operates discontinuously; however, by adding a density factor to his function

he was able to transform it into a continuous function with a very high correlation coefficient. In its initial form, Carrasco's law was able to account for asteroids, planets, satellites, main-sequence stars, double stars, open and glob-

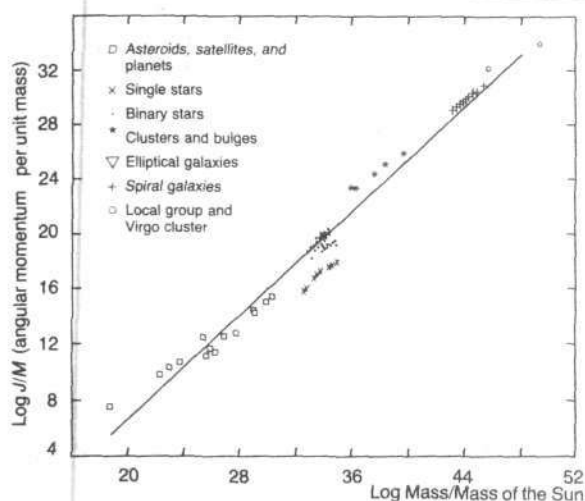

**Figure 2**  
**CORRELATION OF ANGULAR MOMENTUM AND MASS OF ASTRONOMICAL OBJECTS**

Plotted here is the log of specific angular momentum (y axis) in relation to the log of the mass of a large variety of astronomical objects (x axis). Note the high degree of correlation. Angular momentum occurs almost as a line function and does not scatter below a maximum.

Source: Adapted from Luis Carrasco, et al., "Density Scaling of Angular Momentum Versus Mass Universal Relationship," *Astron. and Astrophys.*, Vol. 106, page 89 (1982).

	Rotational Specific Spin Angular Momentum (cm <sup>2</sup> /sec)	Planet Mass (× 10 <sup>17</sup> g)	log j	log M	M <sup>2/3</sup> × 10 <sup>18</sup>	RSAM × 10 <sup>13</sup> (cm <sup>2</sup> /sec)	M <sup>2/3</sup> Earth = 1	Earth-Moon = 1
Mercury	2.86 × 10 <sup>10</sup>	0.322	10.456	26.508	0.479	0.00286	0.145	
Venus	3.68 × 10 <sup>10</sup>	4.81	10.566	27.682	2.85	0.00368	0.865	
Earth	9.86 × 10 <sup>12</sup>	5.98	12.994	27.777	3.29	0.986	1.000	
Earth plus Moon	5.77 × 10 <sup>13</sup>	6.05	17.764	27.782	3.32	5.77	1.008	1.000
Mars	3.02 × 10 <sup>12</sup>	0.643	12.48	26.808	.745	0.302	0.226	0.052
Jupiter	2.25 × 10 <sup>15</sup>	1,880	15.352	30.247	152	225	46.1	38.99
Saturn	1.16 × 10 <sup>15</sup>	562	15.064	29.750	68	116	20.6	20.1
Uranus	2.19 × 10 <sup>14</sup>	85.7	14.34	28.933	19.4	21.9	5.89	3.8
Neptune	1.52 × 10 <sup>14</sup>	103	14.183	29.013	22	15.2	6.68	2.63
Pluto		...	4.9					

$$j = \alpha r^2 \omega \log j \sim \frac{2}{3} \log M - 4.76 \text{ for Earth-Moon, Saturn, and Jupiter}$$

**Table 1**  
**THE CORRELATION OF ANGULAR MOMENTUM AND MASS FOR THE PLANETS**

Carrasco's law of the inverse relationship of angular velocity and mass holds also for the planets of the solar system, as can be seen by comparing column 1 with 2 or column 3 with 4. Mercury and Venus must be discounted because of tidal effects that have modified their spins over time.

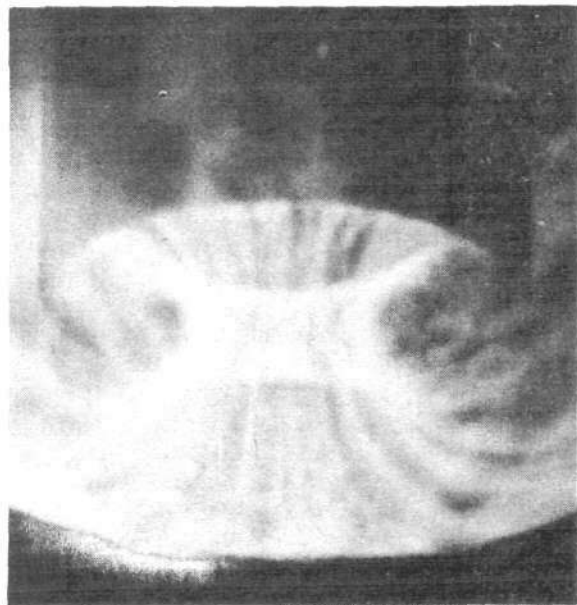

Photograph courtesy of Dr. Winston Bostick

**Figure 3**  
**VORTEX FILAMENTS**  
**CREATED IN A LABORATORY PLASMA**

*These vortex filaments were formed from the current sheath in the plasma discharge from a theta-pinch machine in the laboratory of Dr. Winston Bostick at the Stevens Institute of Technology in New Jersey. Bostick predicted in the 1950s that these self-organized coherent plasma structures would be found in space in the large.*

ular clusters, bulges, elliptical and spiral galaxies, local groups of galaxies, and superclusters. With the exception of spiral galaxies noted above, he found that within each of these categories, whose mass and specific spin angular momentum increase exponentially, there is a high degree of relationship between mass and momentum. Plotted on a log-log graph they appear as step functions. However, by including an additional density factor—actually a step suggested in 1967 by the astronomer Ozernoy—Carrasco found that he could achieve a dramatic improvement in his data: a continuous linear correlation on a log-log graph. Since this density factor operates over 24 orders of magnitude, it is by no means negligible (Figure 6).

**Newton's Method or Kepler's Method?**

The very simplicity of Carrasco's results has resulted in his work being undervalued by astronomers. Yet, of course, it is precisely this quality of apparent simplicity that characterizes all important scientific breakthroughs. Kepler's work, too, was simple. Unfortunately, since the death of Bernhard Riemann in 1866, scientists have increasingly been diverted from the path of Kepler into the sterile methodology of Isaac Newton.

The question is indeed one of method—obviously no modern scientist would espouse Newton's mechanics in place of relativity theory or quantum theory. What they do

share with Newton, however, is the conviction that the universe is fundamentally linear—or entropic. For the work of Carrasco or Bostick to receive the attention it deserves, for a new generation of scientists to be educated so that a much needed scientific renaissance occurs, the fundamental issues raised by Newton's attack upon Kepler must be resolved once and for all in Kepler's favor.

Isaac Newton rejected Kepler's emphasis on the primacy of rotational action. Instead, he believed that the universe was composed of material atoms moving through a vacuum, whose tendency was always to move in a straight line. For Newton, the orbital pathway of a planet was not a continuous curve but an infinite-sided polygon, whose sides were infinitely small. Essentially, he tried to square the circle with his physics. It is as if he could only see the heavens through the prism of a computer simulation—an ellipse projected onto the screen of a computer as a series of linear approximations.

Kepler adopted the point of view of Plato and Nicholas of Cusa. He recognized that the universe was *necessarily* created by rotational action. It was one of his outstanding contributions to recognize that in the case of the planets this rotational action was elliptical rather than circular, and to understand that this elliptical form of the planetary orbits indicates the existence of a force field that governs the interaction of the planets and the Sun, and represents work done upon itself by the universe. Kepler identified this field as a magnetic field.

A merely cursory knowledge of astronomy would convince even the most "empirically minded" that the universe is indeed governed by rotational motion, were he or she not fettered by the bonds of ideology. Not only are the orbits of the planets elliptical, but galaxies take the form of spirals and ellipses. Yet the dead weight of Newtonian epistemology still stultifies mathematical physics and astronomy to this day. By asserting the primacy of linear action, Newton constructed a theory to give ideological substantiation to his view of the universe. A linear universe, by definition, must be dissipative, entropic in nature. Newton's hysterical demand that all orbital motion be resolved into linear motion was merely a thin veneer to make credible his claim that the universe was doomed to suffer heat death.

Since the hard balls of which the matter was putatively composed would lose energy as they collided with each other, gradually all motion in the universe would come to a halt. To account for observed rotational motion, Newton was forced to endow his hard balls with certain occult qualities. They were able to attract each other over immense distances separated by a vacuum, and this attraction, according to him, was propagated instantaneously. This was his theory of gravity. With such a theory, which even he found to be embarrassing on epistemological grounds, it is not surprising that he found it necessary to assert that it was not the responsibility of a scientist to offer hypotheses to explain how physical processes occur, but only to describe them. This, of course, has become the credo of the antirational cult of quantum mechanics.

In the modern period, Albert Einstein attempted to offer a cosmological alternative to Newton's theory; however, it was based on the flawed premise that while the universe



**Figure 4**  
**FILAMENTARY STRUCTURE**  
**NEAR THE GALACTIC CENTER**

Recent observations with a radio telescope of a system of narrow filamentary structures perpendicular to the galactic plane that are parallel to each other, regular, unbroken, and homogeneous in appearance. The typical width is 20 arc seconds. A halo of 8 arc minutes diameter surrounding the shell can also be seen, consisting of a number of large-scale protrusions directed perpendicular to the galactic plane. These radio continuum observations of Sagittarius A were made by Mark R. Morris, Farhad Yusef-Zadeh, and Don R. Chance with data from the 27-antenna Very Large Array radio telescope in Socorro, New Mexico.

The National Radio Astronomy Observatory, operated by Associated Universities, Inc. under contract with the National Science Foundation

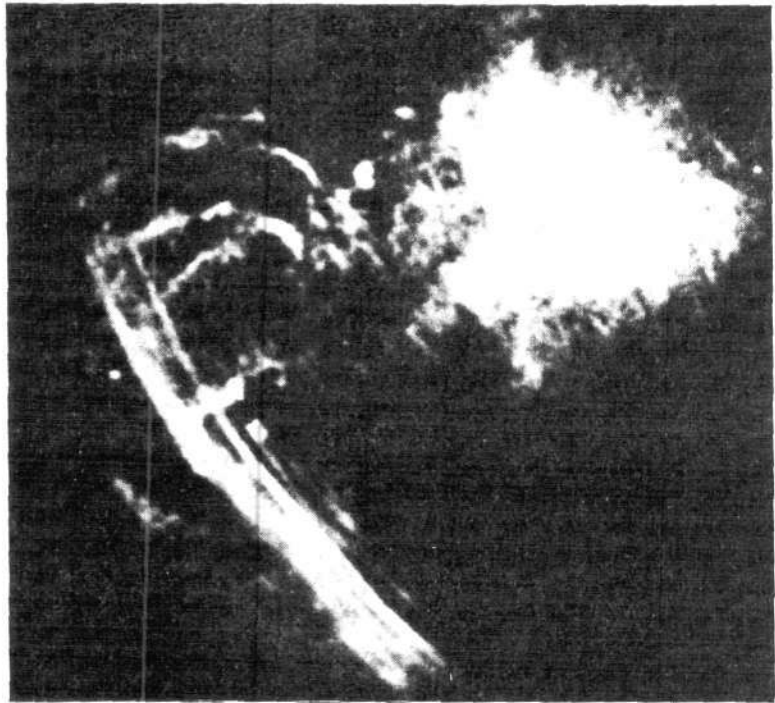

was curved in the large, it could be treated as linear in the small. Such a universe would necessarily lack capacity for growth and development, since change could only be an epiphenomenon of the rearrangement of what already existed, and energy could not be created. Such a universe would be fundamentally entropic, even if it were locally negentropic. Thus, Einstein's universe leads to the apparent cosmological alternatives of the Big Bang hypothesis: Either the universe will keep expanding and dissipate, or it will alternately expand and then implode, going through successive phases of destruction and re-creation.

**Natural Law**

The methodological point at issue is illustrated by the two following quotations, one from Newton and the other from Kepler. For Newton, man is a diminutive creature in a universe that operates by mechanical laws; for Kepler, man's true vocation is to be a scientist who views the universe as its Creator would. For Kepler, the "imitation of Christ" is a scientific as well as moral imperative for man.

Here is what Isaac Newton writes in his *Mathematical Principles of Natural Philosophy*, Book 3.

This most beautiful system of the Sun, planets, and comets, could only proceed from the counsel and dominion of an intelligent and powerful Being. . . . This being governs all things, not as the soul of the world, but as Lord over all; and on account of his dominion is wont to be called Lord God or Ruler; for God is a relative word, and has respect to servants; and Deity is the dominion of God not over his own body, as those who fancy God to be the soul of the world, but over servants. . . . As a blind man has no idea of colors, so have

we no idea of the manner in which the all wise God perceives and understands things. . . . What the real substance of any thing is we know not.

For Newton, just as for Niels Bohr, the universe is fundamentally irrational and unknowable, and God is a pagan deity. Tragically for the moral fiber of the society as a whole, this school of physics is dominant today.

Kepler had a directly opposite view of science. As a humanist scientist and republican, Johannes Kepler charted a course for Gottfried Leibniz, Karl Gauss, and Bernhard Riemann. In Kepler's earliest work, *Secrets of the Universe*, he wrote:

For would that excellent Creator, who has introduced nothing into nature without thoroughly foreseeing not only its necessity, but its beauty and power to delight, have left only the mind of man, the lord of all nature, made in his own image, without any delight? . . . For the reason why the mind was joined to the senses by our Maker is not only so that man should maintain himself . . . but also so that from those things which our eyes perceive to exist we should strive towards the causes of their being and becoming, although we should get nothing else useful from them.

For Kepler, as for all humanists, man's capacity to create is the mirror, within the human soul, of the divine capacity for continuous creation that characterizes the universe as a whole. This epistemology is today reflected only in the scientific work of Lyndon H. LaRouche, Jr. and his collaborators. As LaRouche and Jonathan Tennenbaum, for example, have discussed, only a universe whose principle of action

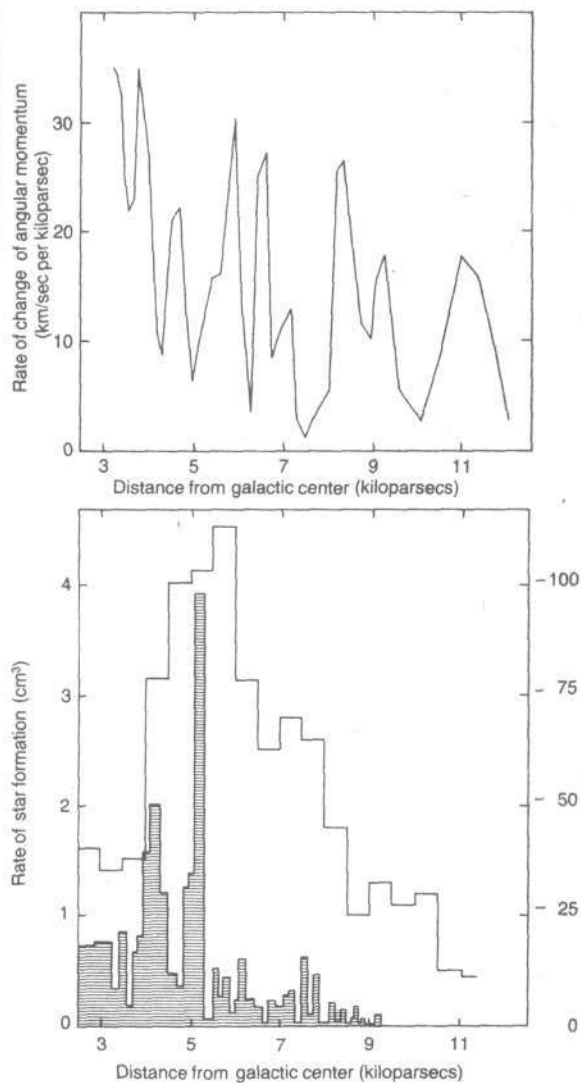

**Figure 5**  
**ANGULAR MOMENTUM, STAR FORMATION,  
 AND GAS DENSITY**

The rate of change of angular velocity (y axis) with distance from the galactic center is shown in (a). (Distance is measured in kiloparsecs; 1 parsec equals 3.26 light years.) There is an inverse relation shown between the peaks and troughs of angular velocity in (a) and the areas of greater and lesser star formation shown in (b). The histogram in (b) shows the radial distribution of gas (solid line) together with a histogram of the radial distribution of the ionized hydrogen, HII, regions (hatched area) for the Milky Way. These HII regions are proportional to the stellar formation rate.

Source: Adapted from Luis Carrasco, et al.

can be modeled as a Gaussian conical function can reproduce itself and develop further.<sup>6</sup>

The model for this is a self-similar spiral upon a cone (Figure 7). One complete rotation of such a spiral determines the boundaries of a planetary orbit, and these

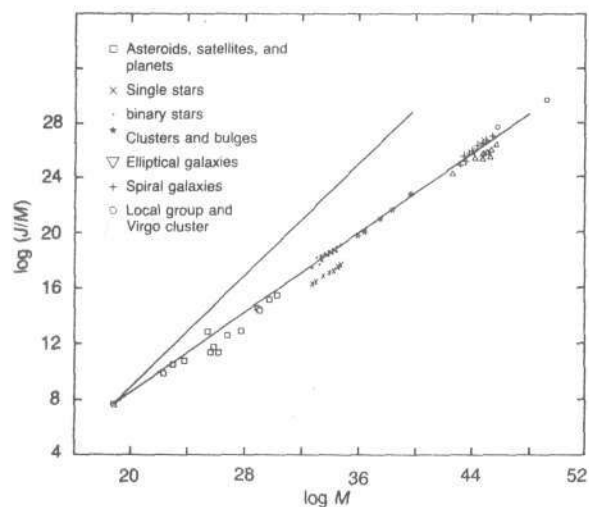

**Figure 6**  
**CORRELATION OF ANGULAR MOMENTUM  
 AND MASS OF ASTRONOMICAL OBJECTS,  
 CORRECTED FOR DENSITY EFFECTS**

Plotted here is the log of specific angular momentum (y axis) in relation to the log of the mass of a large variety of astronomical objects (x axis), as shown in Figure 2, with a correction for density effects. This correction for density enhances the high degree of correlation, and angular momentum occurs nearly as a continuous linear function that operates over 24 orders of magnitude.

Source: Adapted from Luis Carrasco, et al., "Density Scaling of Angular Momentum Versus Mass Universal Relationship," *Astron. and Astrophys.*, Vol. 106, page 89 (1982).

bounding circles can be orthogonally projected onto a plane to produce an ellipse, whose major focus lies at the vertex of the generating cone. The net work accomplished by the universe in creating the planet can be measured as the discrepancy between the arithmetical and geometrical mean of the bounding circles. These give the semimajor and semiminor axes of the elliptical orbit. They also indicate the exponentially increasing rate of growth of the spiral, since in half the time of a complete rotation the spiral has only grown to its geometric mean, leaving the major amount of net work to be created in the second half of its rotation.

In the process of creating a given planet, the universe accomplishes net work upon itself. This is preserved in the form of the planet's elliptical rather than circular orbit. The ellipse must be seen as a projection of the original spiral action upon the plane of the ecliptic, which conserves that action in the form of repeated action. The orbiting planet exists in a force-free configuration. Gravitational force, such as Newton described, occurs only when an object gets out of orbit, as is the case when it is lifted above the Earth, without orbiting around it. The tendency of plasmas to organize themselves in such force-free structures is not limited to astronomical bodies. As Bostick has shown, energy-dense plasmas tend to organize themselves in force-free structures. For example, in experiments he has conducted

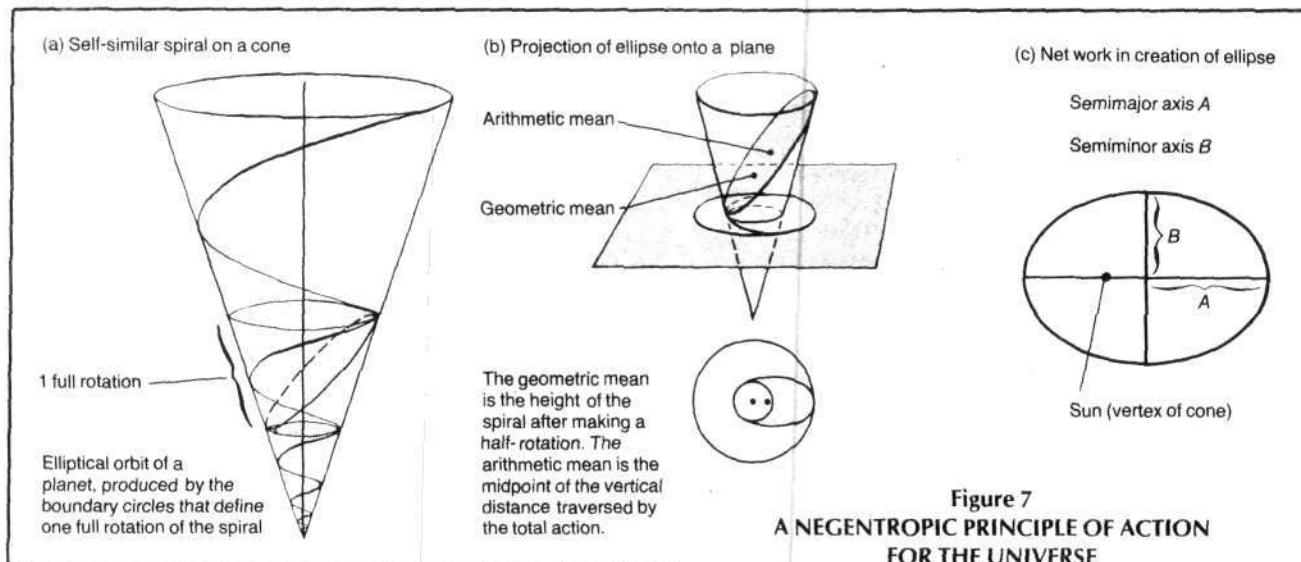

**Figure 7**  
**A NEGENTROPIC PRINCIPLE OF ACTION**  
**FOR THE UNIVERSE**

*The model for a universe that can reproduce itself and develop further is a self-similar spiral on a cone (a). One complete rotation of this spiral determines the boundaries of an elliptical planetary orbit. When orthogonally projected onto a plane, the ellipse produced by these bounding circles produces another ellipse, whose major focus, the Sun, lies at the vertex of the generating cone (b). The net work accomplished by the universe in creating this planet can be measured as the discrepancy between the arithmetic and geometric means of the bounding circles, which give the semimajor (A) and semiminor (B) axes of the elliptical orbit (c).*

at the Stevens Institute of Technology in New Jersey, using a plasma-focus machine, he has found that the vortices the device produces align themselves in a force-free Beltrami flow, in which the electric, magnetic, and velocity fields all travel in the same direction.

#### Kepler's Laws

Kepler's laws of planetary motion are usefully stated in terms of angular momentum. He viewed the planetary orbits as the product of two different actions occurring simultaneously. According to Kepler, the spinning Sun carries the planets around it in a series of circular orbits that are deformed into ellipses because the Sun alternately repels and attracts the planets, as a magnet would. He assumes that while the planets have both magnetic north and south poles on their surface, that the Sun has only one surface polarity, with the other pole at its center.

As Gottfried Leibniz showed in a spirited attack he wrote to refute Newton's *Principles of Nature*, these particular assumptions about the difference between the "magnetic" action of the Sun and of the planets are unnecessary. Leibniz used the discovery by Christiaan Huyghens that the centrifugal force produced by rotational motion would combine with a vortical magnetic field. The combined action of both would account for variation of the orbiting planet's radial distance from the Sun, which determines its orbit as that of an ellipse.

Key to Leibniz's approach was the insistence that gravity could be understood only as an impulsion produced by vortical action of the etherial medium in which the planets were situated. As Leibniz said, attacking Newton for occultism, no other physical hypothesis could account for the fact that the planets maintain their orbit, despite what he called their tendency to break out of orbit in a tangential direction. Leibniz insisted that even taken at its own value, Newton's theory of gravity could not account for the simple fact that the planets all travel in the same direction, since for him their initial velocity is arbitrary.

Kepler actually discovered his so-called Second Law, the law of conservation of angular momentum, before he de-

termined that the orbits of the planets were elliptical, his so-called First Law. The Second Law states that if no external force is brought to bear, a system will conserve its angular momentum. In such a system, as a planet approaches more closely to the Sun it will speed up; conversely, its orbital velocity will be reduced as it recedes from the Sun. This is an inverse variation of orbital velocity and radius, and an inverse square relationship between the angular frequency and radial distance. This being the case, the radius of a planet will always sweep out an equal area of the orbital ellipse, in an equal amount of time.

Kepler's Third Law can be derived by taking the ratio of the area of the ellipse swept out by an imaginary radius connecting the planet to the Sun, and one-half of its angular momentum. This will give the period of its planetary "year." Now it is only necessary to note that the semilatus rectum (the radius perpendicular to the major axis) of the orbit is equal to the square of the angular momentum multiplied by a constant mass factor. Substituting the ratio of the square of the semiminor axis to the semimajor axis, the usual formula results. The angular momentums of the different planets will be related as the square root of their semilatus recti, respectively.

Kepler was concerned in his earliest work, reported in *Secrets of the Universe*, to account for why certain orbits were preferred over others. In the course of his life he

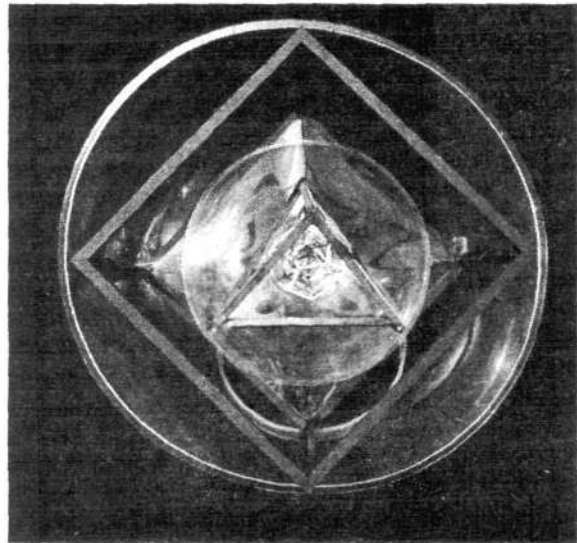

**Figure 8**  
**KEPLER'S DETERMINATION OF**  
**THE ORBITS OF THE PLANETS**

Kepler determined the distance of the planets from the Sun by representing the orbits of the six planets known then as nested spheres separated by the five Platonic solids, as shown in this model. The largest sphere represents Saturn's orbit, and inside it is a cube. The sphere inside the cube represents Jupiter's orbit, and inscribed in this sphere is a tetrahedron. Inside the tetrahedron is a sphere representing Mars, in which is inscribed a dodecahedron. Similarly, this dodecahedron gives the sphere for Earth, the icosahedron for Venus, and the octahedron for Mercury, the innermost sphere.

Kepler's discovery appeared in the first edition of his book *The Secret of the Universe* in 1596.

Model constructed by Michael Micale

offered two complementary hypotheses. The first related the orbits by supposing them to be circles on spheres that enclosed the five regular Platonic solids, beginning with the cube, which separated Saturn and Jupiter, and then embedding the other planets in a tetrahedron, dodecahedron, icosahedron, and octahedron, respectively (Figure 8). The results he achieved for the orbital distances from the Sun are remarkably accurate to this day.

At the close of his life, Kepler introduced a second hypothesis that accounted for the eccentricity of the elliptical orbits according to the harmonic relationship between the angular velocities of the planets at their nearest and farthest distance from the Sun—at perihelion and aphelion. He compared the extreme angular velocities of a given planet with the converging and diverging extreme velocities of neighboring planets (that is, one at aphelion with the other at perihelion). He found that these velocities could be treated as notes of a scale—and indeed were related as scale steps in a predominantly minor key (Table 2). This relation-

Planet	Ratio of Angular Velocity of Perihelion to Aphelion (kilometers per second)	Consonant Interval
Mercury	38.824 : 58.921	Minor third
Venus	34.78 : 35.256	Almost the same note
Earth	29.278 : 30.272	Almost the same note
Mars	21.964 : 26.490	Fifth
Jupiter	12.435 : 13.7	Minor third
Saturn	9.128 : 10.177	Major third
Uranus	6.4902 : 7.1161	Minor third
Neptune	5.3833 : 5.4732	Almost the same note
Pluto	3.6763 : 6.1024	Devil's interval

**Table 2**  
**KEPLER'S HARMONY OF THE PLANETS**

Kepler found that the ratio of the angular velocity of a planet at its nearest point to the Sun (perihelion) to the angular velocity at its farthest point from the Sun (aphelion) is consonant. Shown here are these ratios for each planet and the harmonious intervals they sound.

ship is borne out by the later discovery of the planets Neptune and Uranus. The one exception to this rule, discovered by Gauss's collaborator Johan Wilhelm Andreas Pfaff, ironically confirms it; the four largest asteroids not only do not have their extreme velocities within one scale, but also are totally discordant—making the so-called devil's interval of an augmented fourth. Thus, the orbit between Mars and Jupiter is confirmed to be an unstable orbit.

In this aspect of his work, Kepler can be best likened to Leonardo da Vinci, whose scientific discoveries were critical to the scientific renaissance that created the industrial revolution. Da Vinci discovered that all living forms developed morphologically according to a golden mean ratio. Kepler looked to the same principle in searching for a relationship between the embedded solids and a harmonic principle of music. It is this aspect of his work that must be carried forward, in the direction outlined by LaRouche and Tennenbaum, if we are to go further in our search to discover how the universe is created.

*Carol White is the editor-in-chief of Fusion magazine.*

#### Notes

1. See, for example, L. Carrasco, M. Roth, and A. Serrano, "Density Scaling of the Angular Momentum Versus Mass Universal Relationship," *Astron. and Astrophys.*, Vol. 106, page 89 (1982).
2. L.M. Ozernoy, *Astron. Tsirk.*, Nos. 405, 407, 422 (1967).
3. R.P. Kraft, in *Spectroscopic Astrophysics*, ed. G. Herbig (Berkeley: University of California Press, 1970), p. 385.
4. P. Brosche, *Astrophys. Space Sci.*, Vol. 51, page 401 (1977).
5. Winston Bostick, *Phys. Rev.*, Vol. 104, page 292 (1956); Vol. 106, page 404 (1957); "Plasmoids," *Sci. Amer.*, Vol. 197, page 81 (Oct. 1957); *Rev. Mod. Phys.*, Vol. 30, No. 3, page 1090 (1958).
6. LaRouche discusses the concepts of work and energy in "Why I Must Attack Albert Einstein," *Fusion*, July-Aug. 1984, p. 41. Tennenbaum discusses these ideas in "How Man Transforms the Laws of the Universe," *Fusion*, May-June 1984, p. 19.



# Food Irradiation

## *A Technology Ready for a Production Boom*

by Marjorie Mazel Hecht

*There is a cheap and efficient way to expand the world's food supply—food irradiation. Yet the implementation of this beneficial technology has been stalled by the same Malthusian lobby that has blocked the development of civilian nuclear power worldwide.*

*Low dose irradiation could save the 33 million tons of grain per year that never reach the consumer because of insect infestation and spoilage—enough to feed 230 million people for a year. Here, grain is being loaded onto barges in Kansas City.*

FISH THAT STAYS FRESH in the refrigerator for two or three weeks, strawberries that don't go bad, potatoes that don't sprout, and flour that doesn't get mealy: This was the promise of food irradiation in the Atoms for Peace days of the 1950s, and 30 years of extensive testing have proved the technology to live up to every bit of the spectacular expectations. Irradiation eliminates insect infestation, retards spoilage, prolongs shelf life, ensures purity, and permits shipping and storage of meats without refrigeration—all at relatively low cost.

Furthermore, food processed with gamma irradiation or X-rays from an electron beam accelerator is perfectly safe, tastes good, and is as wholesome as it is when fresh. For these reasons, irradiated food (including dinners of beef, pork, smoked turkey, and corned beef) was selected by the U.S. National Aeronautics and Space Agency as the most tasty, pure, and convenient way to feed astronauts in flight.

Perhaps most incredible, the technology of food irradiation brings the promise of nearly doubling the food available for consumption in some parts of the world, not by producing more food, but by ensuring that current food supplies are not lost to insects, rodents, or fungi. At present, an estimated 50 to 60 percent of the food shipped to or

produced in much of the developing sector never reaches the intended consumer because of insect infestation and spoilage. In terms of grain alone, the amount lost to insects, rats, and fungi yearly is 33 million tons—the equivalent of the agricultural production of 12 million acres of land, or enough to feed the U.S. population for a year! The U.S. National Academy of Sciences estimated that by 1985, food losses would total at least 107 million tons per year at a value of \$11.5 billion.

Food irradiation is also cheap, when compared to present methods of food preservation, like canning and chemical treatment. Initial cost estimates put the cost as low as one-third that of conventional methods.

#### A Proven Technology

The technology of food irradiation is not new, although it has not yet been commercialized in the United States. A long-awaited pending change in the U.S. Food and Drug Administration regulations, however, will open the door to commercialization and should spur further use of food irradiation worldwide.

Scientists began investigating the usefulness of nuclear irradiation during World War II, and it has undergone nearly 40 years of rigorous testing for safety and wholesomeness, coming out with a clean bill of health. As the U.S. Atomic Energy Agency put it in 1970, food irradiation has

been "more thoroughly tested than any other method of food preservation."

Given these outstanding benefits, the obvious question is: What has prevented this technology from being commercialized in the United States, the country that led the world in civilian nuclear development?

The answer is one that even veterans in the nuclear technology field puzzle over. In the early 1950s, in the spirit of President Eisenhower's Atoms for Peace program, the United States was gearing up to commercialize food irradiation under joint government and private management, at first for use by the U.S. Army to produce food for the troops that would not require refrigeration. But just as construction was confirmed for what the Department of Defense called "the first and most comprehensive pilot production-size food radiation facility in the world," in Stockton, Calif., the U.S. Congress killed the emerging technology outright by classifying irradiation as a "food additive," instead of a process. The 1958 Food Additives Amendment to the Food, Drug, and Cosmetic Act classified as a food additive "any substance and any source of radiation intended for use in producing, manufacturing, packing, processing, preparing, treating, packaging, transporting, or holding food."

This classification effectively stopped commercialization of food irradiation, putting those interested in promoting

## How It Works

Food irradiation uses the ionizing radiation (or ionizing energy) from a decaying radionuclide such as cobalt-60 or cesium-137 as its radiation source. X-rays and electron beams can also be used as the source of radiation.

The very short wavelength gamma rays penetrate inside solid particles and kill microorganisms by breaking down the cell walls or destroying the metabolic pathways of the organism, so that the cell dies. At higher doses, all microorganisms are killed, sterilizing the processed food.

*There is no radioactivity induced in the processed food.* The chemical reaction caused by the gamma rays does not involve the atomic nuclei of the food, and therefore the atomic structure of the molecules is not changed. Of course, some natural radiation, called background radiation, is present in all foods, but irradiation processing does not add to this.

One of the bugaboos of food irradiation has been the claim that gamma rays would change the chemical struc-

ture of the food, producing unique radiolytic products (chemicals) that might prove harmful. All the years of testing, however, have determined that of the radiolytic products produced, 90 percent are the same as those in nonirradiated food. The remaining 10 percent are chemically similar to natural food components and constitute only 3 parts per million of the processed food.

The conclusion of the FDA is that the difference between irradiated and nonirradiated foods is "so small as to make the foods indistinguishable in respect to safety."

Gamma irradiation is a "cold" process; that is, it produces no significant temperature increase in the food. This makes it particularly useful for fumigating spices, because it does not drive off the volatile substances that give spices their characteristic flavor and aroma. Irradiation also does not damage the nutritional quality of the food.

In fact, in radiation sterilization, the low temperature allows meats to retain more of their nutrients than do the other methods of preservation, such as canning.

The penetration capability of the gamma irradiation permits the processing of food that is already packaged and sealed, thus ensuring that no new contamination takes place in the packing process. Packaging materials have been developed and approved by the FDA for use in food irradiation.

#### Irradiation Facilities

Irradiation facilities for food or medical supplies are not elaborate: There is the radiation source with its shielding, an automatic conveyor system that transports the produce to and from the source, various control systems to manage the processing at the appropriate rate, and storage facilities.

In a typical facility, the cobalt-60 is embedded in pencil-thin rods, which

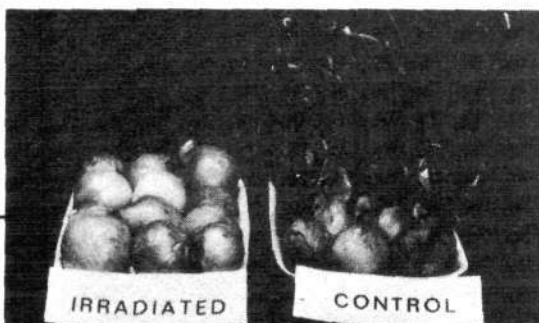

*The irradiated sample 18 months later is as good as new.*

the technology in the position of applying for clearance to the FDA product by product, with extensive testing to prove safety and wholesomeness. According to one authority, this required spending at least \$250,000 for each item to conduct three years of tests in which the three to five generations of animals eat the particular food under consideration for 30 to 40 percent of their daily diet. The FDA procedure resulted in an enormous amount of excellent research on all aspects of food irradiation; but in 26 years, the only products that the United States has permitted to be irradiated are potatoes to prevent sprouting, grain to prevent infestation, and, most recently (July 1983), spices. Petitions to permit irradiation of many other foods were turned down by the FDA, despite extensive government and industry testing that showed safety and wholesomeness.

What prompted this strange amendment in 1958? One long-time researcher blames actress Gloria Swanson, a food faddist and the Jane Fonda of her day, who lobbied strongly for eliminating any potentially "cancer-causing" additives to food.

In the years of plentiful energy and booming agricultural productivity, there was not a lot of pressure in the United States to change this situation. However, for the developing sector—countries where often the majority of a post-harvest crop is lost to pests or fungi—the effect of this U.S. slowdown in research and development can be measured

in terms of starvation and death. As A. Sreenivasan, a scientist at the Bhabha Atomic Research Center in Trombay, India, told a 1972 conference on food irradiation in Bombay sponsored by the International Atomic Energy Agency: "Perhaps the greatest negative input that can be singled out for its adverse impact on food irradiation programs around the world has been the action of the U.S. Food and Drug Administration in withholding clearance for radiation-sterilized ham and in revoking that given earlier to radiation-sterilized bacon. . . . The action of the U.S. FDA has resulted in a misunderstanding in some quarters over the safety of irradiation procedures for food preservation as a whole."

#### The U.S. Army Program

The pioneer agency in food irradiation research is the U.S. Army, which during World War II asked the Massachusetts Institute of Technology to investigate whether irradiation could extend the shelf life of foods needed for feeding the troops abroad. Within five years, MIT had demonstrated the efficacy of food irradiation, and in 1953, the Army set up a special laboratory center—the Quartermaster Corps Research and Development Command in Natick, Mass., near Boston—to consolidate the government-sponsored food irradiation projects.

The history of this Natick lab is a success story in the development of an advanced technology. Once scientists

are submerged in a well of water that serves as a shield to protect the personnel from the radiation when the source is not in use. About 10,000 curies of radiation are contained in each pencil. The area housing the gamma irradiation source is shielded with six to eight feet of concrete. The products to be irradiated travel on conveyor belts

to the source, which is automatically raised out of the water on cables when needed. The dose of radiation received depends on the time of exposure and also the product's distance from the source.

The capital cost of such a basic unit may be as much as \$2 million, but with the proper design, the same facility

could handle both food products and medical supplies simultaneously, thus ensuring maximum use of the equipment.

Ninety percent of the cobalt-60 used in irradiating medical products and food is supplied by Atomic Energy of Canada Limited, a crown corporation, which produces the cobalt-60 as a by-product of its fission reactors. The U.S. Department of Energy is experimenting on a very small scale with cesium-137 as a radiation source, using the waste products from the nuclear defense project. While cobalt-60 has an effective lifetime of 5.5 years before it must be replaced, cesium-137 lasts for 30 years, and its use in food irradiation would literally halve the amount of nuclear waste that the nation has to dispose of.

The DOE is now building a transportable irradiation unit, the Transportable Cesium-137 Irradiator or TPCI, which is expected to test the effectiveness of irradiation in disinfecting crops such as citrus fruits right at the harvest site. Such a facility would also be useful in developing countries, where there is a lack of transportation at the harvest and storage site.

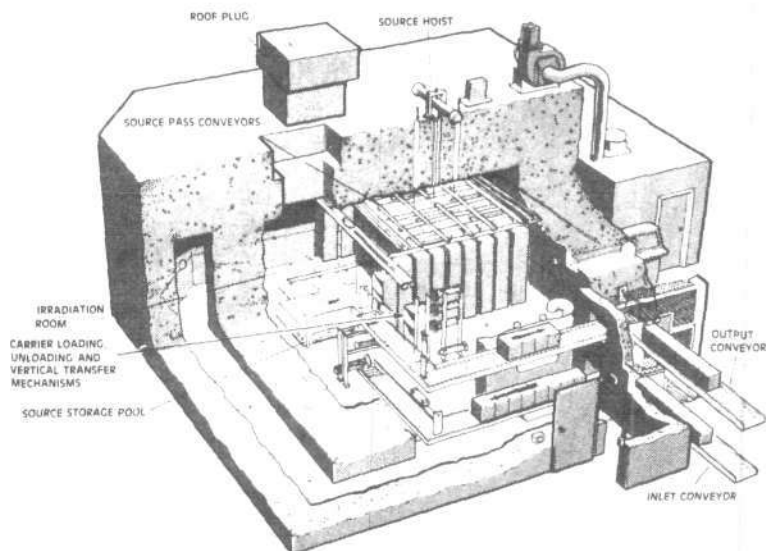

One of the plant designs available from Atomic Energy of Canada, Ltd.

Radiation Technology president Dr. Martin A. Welt at his New Jersey plant. On display are samples of irradiated meat, poultry, and beans that are just as fresh today in their sealed packages as they were when they were processed several years ago.

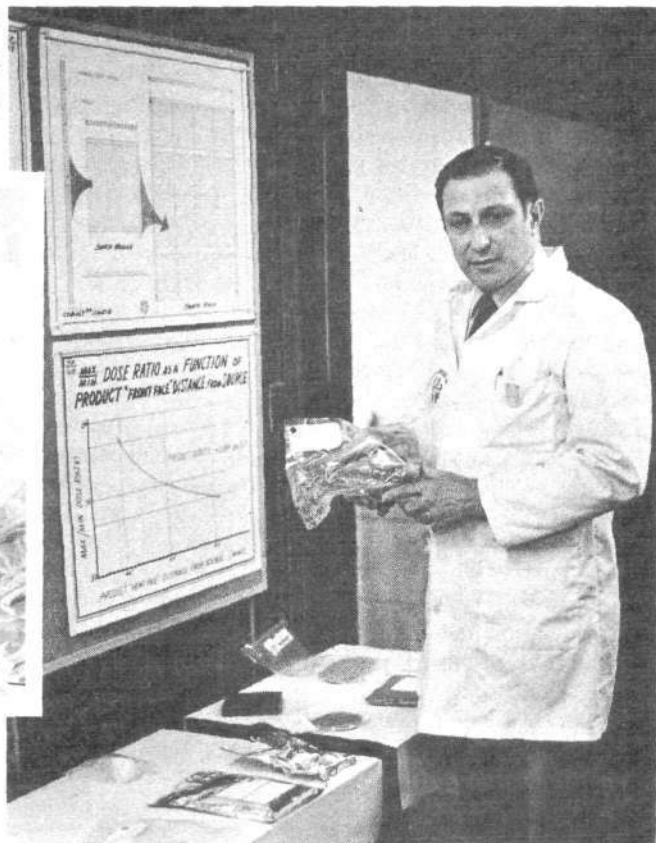

Stuart K. Lewis

knew in general what the technology could do, they set out to perfect it. As described by Dr. Eugen Wierbicki, a research leader in the project, the U.S. Army program was designed to determine which conditions—irradiation level, temperature of processed food, packaging, and so on—would produce the most wholesome and tasty products as well as to test the effect of feeding irradiated food to generations of animals. Scientists had to be sure, for example, that the irradiation did not cause the formation of any deleterious radiolytic products in the food being processed, and that there were no genetic changes induced from a diet of irradiated food. They also had to solve aesthetic problems, such as the funny smell that the early experiments with high dose radiation produced in meats; and they had to develop the appropriate packaging materials in which to seal the food product before irradiation.

Just at the point when the Natick laboratory had without question advanced the technology of food irradiation to the commercialization stage—that is, having produced the data that could objectively meet the stringent specifications of the U.S. Food and Drug Administration—the U.S. Army, under the Carter administration, disbanded the program. In October 1980, all 56 scientists at the laboratory were dispersed around the country, the irradiation source (cobalt-60) was given to a state university for research use, and the laboratory was shut down. The ostensible reason given was that the Army should no longer be involved in something that was ready for commercialization. However, this deliberate destruction of a successful U.S. research team on the verge of realizing the fruits of 30 years' labor is a vivid example of how food irradiation has been sabotaged to prevent the technology from implementing its most important promise: the elimination of hunger and starvation in the world simply by preventing food loss to insects and spoilage.

Today only one of the Natick scientists is still working on food irradiation, under the aegis of the U.S. Department of Agriculture, which took administrative control of the Natick project.

### Taking the Technology Off the Shelf

The U.S. Food and Drug Administration in March 1981 published an advanced notice of its proposed change in regulations for the approval of irradiated foods. Although a very small step—allowing foods processed with up to 100 kilorads to be commercially marketed with no further testing—it was not until Feb. 14, 1984 that the proposal was given a preliminary green light by the secretary of Health and Human Services, Margaret Heckler, whose agency had been reviewing the proposed change for three years. The public was given 90 days to comment on the proposed new regulations, and the FDA is expected in early 1985 to issue the final version of the new rules, which will then be law.

Once law, the new regulations will open the door for commercialization of food irradiation in the United States, although the proposed allowable dosage—100 kilorads—is so low that the full range of benefits of the technology will still be prohibited. Also, since profitability depends upon volume with food irradiation facilities, the proposed 100 kilorad limit of the FDA will restrict commercial growth, by restricting the range of products that can be processed.

This 100 kilorad level of radiation (a rad is a measurement of radiation energy absorbed) is sufficient to inhibit sprouting in onions and potatoes; to eliminate parasites and insects in meat (such as trichina in pork), grains, and soft



fruits; and to delay ripening of perishable foods. But it is far lower than the 1980 regulations set by the Joint Expert Committee on Food Irradiation, an international project involving 25 countries, sponsored by the Food and Agriculture Organization, the World Health Organization, and the International Atomic Energy Agency. This committee established that any food irradiated to a dose of up to 1,000 kilorads (1 megarad) was toxicologically safe for human consumption. A year later, in 1981, the Codex Alimentarius Commission of FAO and WHO supplemented this with a list of recommended international standards for individual irradiated foods. "All the toxicological studies carried out on a large number of irradiated foods, from almost every type of food commodity, have produced no evidence of adverse effects as a result of irradiation," WHO concluded.

The three-year review of the FDA regulations within the Health and Human Services agency has centered on the question of labeling: Should irradiated foods bear the label "irradiated"? The agency concluded that this was not necessary, except for bulk shipments (those not yet packaged for individual sale) so that the product would not be irradiated again in processing it for sale. Some countries, including the Netherlands and South Africa, have adopted a small symbol to label irradiated products. Many experts feel that since the process is so safe, so thoroughly tested, and leaves absolutely no radiation in the product, such labeling is unnecessary and would simply provide a target for the anti-nuclear environmentalists.

(The flavor of such environmentalist opposition can be seen in the remarks of the director of the energy project of the Ralph-Nader-connected antinuclear group Critical Mass, who told the author of a May 1983 *Baltimore Sun* feature on food irradiation: "We haven't had time yet to fully research the issue of irradiated food, but I have an instinctive negative reaction. . . . We oppose on principle the commercialization of nuclear material—whether it's Three Mile Island or smoke detectors. And I basically see this as a way of further legitimizing the weapons business.")

#### **Commercialization: How Soon?**

There are a handful of U.S. private firms ready to go with commercialization of food irradiation, including Radiation Technology, Inc. and Isomedix in New Jersey and International Nutronics in California.

Dr. Martin A. Welt, president of Radiation Technology, Inc. has been the most active advocate of commercialization in the United States for nearly two decades, and it was his petition to the FDA that produced the regulation last July permitting the irradiation of spices. Currently Welt's company operates three plants in the United States to irradiate food for export, including poultry, grapes, strawberries, and fish. Welt has just signed a contract with a Hawaiian firm, for the radiation processing of tropical fruit, such as mangoes and papayas, which must be fumigated before it can be exported. And Welt's company has also just signed a licensing agreement with the Japanese engineering firm, Toyo Engineering Corporation, to expand Radiation Technology's patented multipurpose irradiator system in the Far East and Southeast Asia. The international market, specifically the Pacific Basin and Latin America, is also where In-

ternational Nutronics sees its future. This firm just completed a pilot project plant in Irvine, Calif.

Once the new FDA regulations finally become law, these companies expect to be on the front line of a long-awaited revolution in food processing. One of the immediate U.S. projects will be the use of irradiation on harvested citrus fruits to kill fruit flies and their eggs, now that the pesticide EDB has been banned as a fumigant for this purpose. This use of irradiation, in fact, was specifically mentioned by the Environmental Protection Agency as a viable substitute for EDB, although estimates are that it would take at least 18 months to build the on-site plants required in Florida and other citrus-growing areas. In early March, Radiation Technology successfully completed a series of radiation processing tests involving packaged grapefruits loaded onto pallets in order to determine the feasibility of using gamma radiation for insect disinfestation. Radiation Technology president Welt notes that his plant can process 2 million pounds of the fruit per day, and has expansion capability.

The new FDA regulations should also open up an export boom, for although many other countries now permit the marketing of irradiated foods, the U.S. go-slow attitude has been responsible for the sluggish development of food irradiation worldwide. At this point, the total world output of irradiated food is under 2,000 tons per year, a miniscule amount.

#### **Used in 28 Countries**

The rest of the world has not stood still, however, while the United States reviewed and researched to death the technology of food irradiation. Most countries have worked out their own regulations, many in line with the international recommendations cited above. More than 40 different food products have been cleared by 28 countries, with some countries, such as the Netherlands, approving 20 different foods and Japan, a nation that has pioneered in nuclear technology, irradiating everything from seafood and seaweed to spices. In addition, Canada is aggressively pursuing the lead in exporting food irradiation technology, having built 60 of the 100 or so facilities now in use worldwide for food irradiation and supplying 90 percent of the radiation source, cobalt-60, worldwide, including that used by the American firms to sterilize medical supplies. (About 30 percent of all medical supplies are sterilized by this irradiation method.)

Ironically, unless the United States accelerates commercialization of food irradiation, it may be in a position of importing advanced technology in this area from countries that have moved forward more rapidly. This was the conclusion of California Congressman George Brown who recently visited nuclear technology facilities in India, a developing sector nation that has pursued high-level research and implementation to increase its food supply and the wholesomeness of food products.

It is in the developing sector—where food spoilage is a life and death question because of lack of refrigeration and other infrastructure—that food irradiation could make a critical, short-term difference in providing food to the starving. In 1972, at the international conference in Bombay cited above, the official recommendations of the confer-

ence led with the statement: "Developing countries should promptly move forward in introducing this process regardless of the progress in developed countries where the need for this new method of food preservation may be less acute and where the existence of other established alternative technologies has made it difficult for the introduction of a new process."

Even the U.S. Agency for International Development, which is notorious for its funding of population control and low-technology projects only, considers food irradiation an "appropriate technology" for the Third World. In a recent interview, AID official Dr. Robert Morris predicted that within a year the agency would have an active program in this area. At this point, he said, the technology is being reviewed at the top level of the agency in terms of its potential for treating a wide variety of products. It is definitely more appropriate than freezing as a preservation measure and much cheaper than canning; much of the cost of canned foods for a developing sector—50 to 60 percent—is to purchase the containers, Morris said.

Many developing sector nations have conducted research programs, some under the aegis of the International Atomic Energy Agency, on the feasibility of using gamma irradiation with specific crops. India, for example, has thoroughly studied the feasibility of reducing postharvest losses in onions and potatoes, while Bangladesh has examined the use of irradiation in the preservation of dried fish, a major source of protein in this region. One 1975 study by the Department of Atomic Energy in Bombay concluded that with a commercial irradiator operating at 50 percent capacity for eight months, "high returns on investment may be expected for the economy as a whole and for potential entrepreneurs." U.S. advocates of food irradiation expect that the change in FDA regulations will expedite collaboration with developing nations in implementing these well-studied technologies.

Another key to how fast this revolution in food production will take hold is consumer acceptance. In the United States, the fact that the FDA has dragged out its change in

regulations over the decade of the 1970s means that the public today is considerably more fearful and less able to apply scientific standards than it was in the Atoms for Peace days or even in the days of NASA's Apollo project. This process of devolution, of course, is deliberately fostered by the environmentalist groups promoting a postindustrial society and the media, and there is every indication that both groups will treat food irradiation as just another assault on their natural environment. The *New York Times*, for example, in its article reporting on the proposed FDA regulations noted that "Some scientists... expressed concern about the proposal, saying the long-term safety of food irradiation had not been demonstrated," and then devoted more than one-third of the article to the specific comments of one such scientist, John Gofman. (Gofman's prescriptions for safety testing are such that we probably would not have bathtubs and certainly not automobiles if his judgment had prevailed.)

Curiously, a representative for the Isomedix company told this writer that he was not interested in having a pro-nuclear magazine advocating food irradiation because the company wanted to dissociate itself from the word nuclear to get better consumer acceptance. Specifically, he said he was working with consumer groups associated with Ralph Nader and counting on the cooperation of the Naderites not to attack the irradiation process.

#### The Immediate Future

The new FDA regulations, once law, will permit 100 kilorads of irradiation to process food in the United States. At this low dose level, one of the main applications will be to kill insects. This low-level irradiation is able to easily kill any kind of insect in any physiological stage, compared with other disinfestation measures, which do not always eliminate insect eggs.

With a low dose limit of 100 kilorads:

- potatoes, onions, and garlic can be irradiated to inhibit sprouting (6 to 15 kilorads);
- citrus fruits and tropical fruits can be irradiated to kill

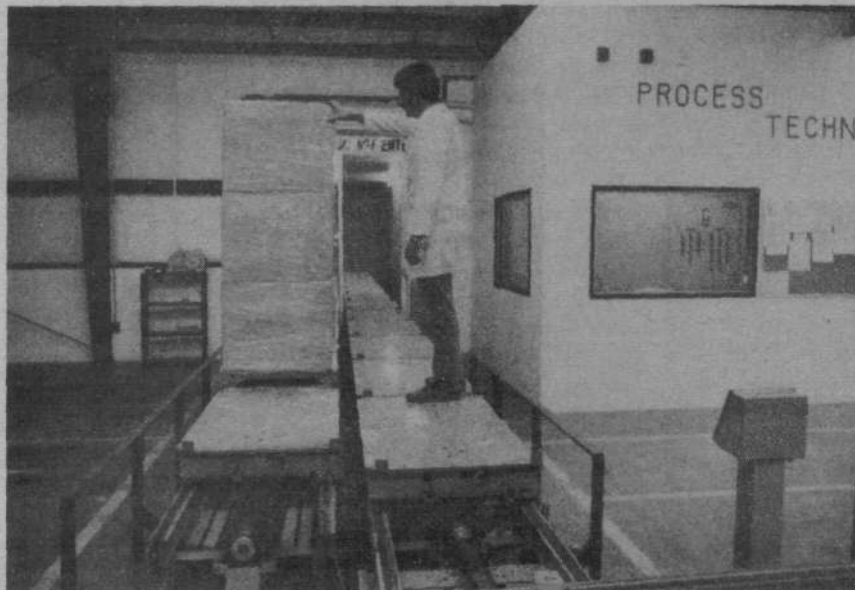

*Radiation Technology, Inc. has plants on Arkansas and North Carolina that can process 1 million pounds each per day of fresh poultry. Right: The control room of a Radiation Technology processing plant, with the automated conveyor system and the entry to the source area seen through the windows. Left: A technician loading containers with the food product to be irradiated onto the conveyor.*

all insects and their eggs (20 to 50 kilorads);

- grain in storage can be disinfested (20 to 100 kilorads);
- strawberries and blueberries can be treated to inhibit mold and prolong shelf life for one to two weeks; and
- bananas, tomatoes, pears, avocados, mangoes, papayas, and other fruits could have their ripening process delayed (25 to 35 kilorads).

The new FDA regulations, however, would not apply to meats, poultry, and fish, which would require a separate FDA regulation. If the FDA grants the same level of irradiation—100 kilorads:

- fresh fish could have its shelf life extended;
- pork could be made free from trichina at just 20 to 30 kilorads (the United States now has one of the highest rates of trichinosis among the advanced sector nations and for this reason, a number of European nations embargo U.S. pork products); and
- ground meat could be decontaminated, prolonging its shelf life by lowering its bacteria count (specifically, the *pseudonoma* bacteria that cause ground meat to putrefy when kept for more than a couple of days are very sensitive to irradiation).

#### **Killing Bacteria and Sterilizing Food**

At the next dose level, 100 to 500 kilorads, radiation can provide other crucial benefits:

At 100 to 300 kilorads, many pathogens can be eliminated from meats and poultry. For example, salmonella, according to the Interdepartmental Committee on Irradiation Preservation, contaminates as much as half of all chicken and leads to more than a million cases of gastroenteritis per year. Atomic Energy of Canada Limited reports this figure as much higher, 10 to 15 million people in North America yearly, and estimates that 250 irradiation facilities could completely eliminate salmonella in poultry at a cost of 2 cents per pound.

At 200 to 500 kilorads, shelf life of many products can be extended significantly, as can refrigerator storage. Poultry, for example, can stay fresh for up to 25 days. This dose level

can also reduce the microbial level of food products significantly. And at 500 kilorads, frozen shrimp and frog legs can be guaranteed free from salmonella.

At even higher dose levels, 500 to 1,000 kilorads, spices, condiments, and dehydrated onions can be fumigated efficiently and with no loss of aroma, since irradiation is a dry process. And at 1,000 to 3,000 kilorads, irradiation could serve as a partial replacement for sodium nitrite in processed meats.

For total sterilization of foods, eliminating all pathogens and viruses, high dose rates of 2.5 to 5 megarads are required. With high dose irradiation and secure packaging, food products including meats can stay fresh without refrigeration indefinitely. This is what the astronauts eat in space, and this is the way hospital patients who require germ-free meals can be fed.

The U.S. Army Natick laboratory developed a high dose radiation technique, which first blanches the meat (to prevent enzyme deterioration), vacuum packs it, and then freezes it and irradiates the packages in the frozen state. Once processed in this way, the meat can be shipped and stored without refrigeration, remaining fresh for years. According to Dr. Eugen Wierbicki, a research leader in the Army program, these meats were rated tasty in tests by U.S. Army personnel and retained their taste and wholesomeness when tested 10 years later.

The FDA has not yet approved this high dose irradiation for sterilization and long-term storage, but a decision is expected after the results of a mammoth 8-year study by the U.S. Army and the USDA on irradiation-sterilized chicken are officially reviewed in the near future. To determine wholesomeness, more than 300,000 pounds of sterilized chicken were fed to various animal species for several generations over a period of years.

As stated by Wierbicki in December 1981, "... there is not a single indication that the irradiated food performed less efficiently than the nonirradiated control or that it caused any abnormalities in organs, reproduction, and growth [of the animals participating in the study].

Many of the researchers who have been working for food irradiation for 30 years, and of course those in the irradiation industry today, have been anticipating the long-awaited commercialization boom since the FDA first announced its intention of changing the regulations on irradiation in March 1981. Their vision is that of the Atoms for Peace years, using the most advanced technology for the benefit of mankind.

As the president of Radiation Technology, Inc., Dr. Martin Welt, put it, "The United States can prove to the world that it cares about underdeveloped nations and their peoples by approving radiation preservation of food for American consumers and making use of this same technology for low cost and extended shelf life shipments to the Third World or disaster areas."

*Marjorie Hecht is the managing editor of Fusion magazine. A follow-up article on commercializing electron-beam food irradiation—a spinoff of the beam weapon defense program at Lawrence Livermore National Laboratory—will appear in a future issue.*



# A Preview of NASA's Manned Space Station

by Marsha Freeman

In just a few years, some of us will have a new kind of address. We won't live in New York or Kansas, or in some other country: We will move off the planet Earth and live in small cities in low-Earth orbit, about 200 miles or so away from Earth. For the first time, man will be able to make his home in space.

The recent successes of the Space Shuttle transportation system mean

that we can now embark on a whole new era of space exploration, space utilization, and space colonization.

By 1992, the U.S. National Aeronautics and Space Administration, NASA, is planning to start operation of its first permanently manned space station. In that year, we will also be celebrating the 500th anniversary of Columbus's discovery of America. Right now, NASA is evaluating de-

signs for the first permanent space station.

### Building a Space Station

The first permanent U.S. space station will be transported to space in the form of separate modules that are built on Earth. These modules will consist principally of living quarters and complex instrumentation packages. They will be delivered to low-Earth orbit in the Shuttle cargo bay.

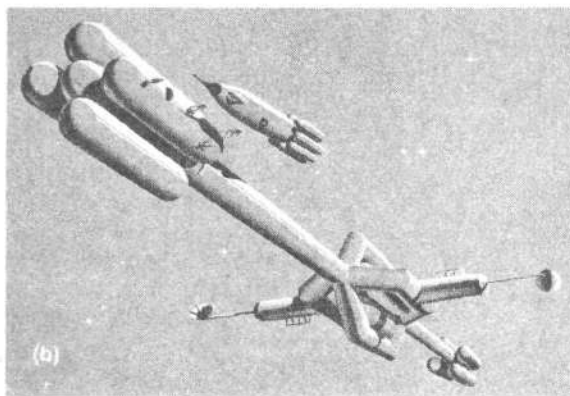
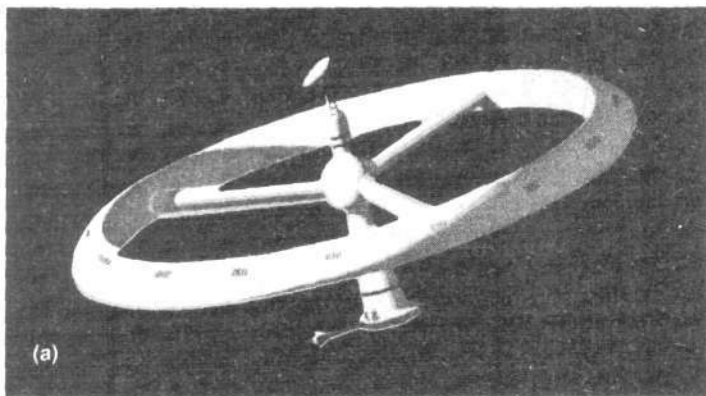
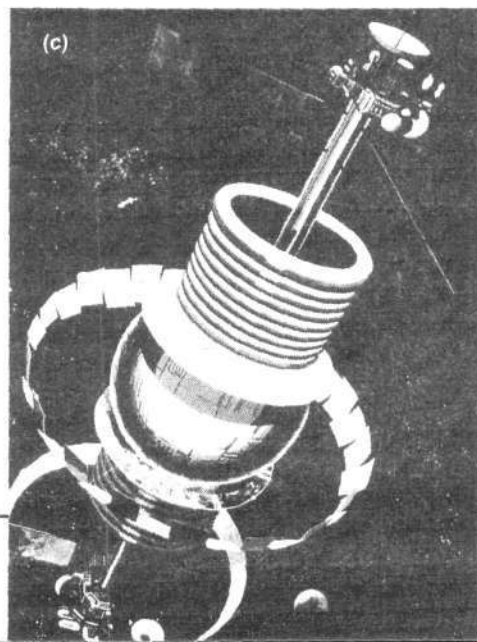

**Figure 1**  
**EARLY SPACE STATION DESIGNS**

Early space station designs looked like large spinning wheels or tops (a). Space scientist Krafft Ehrlicke's early design (b) resembled a paddlewheel. He designed this fueling station satellite to rotate around its hub more than two times a minute, producing an artificial gravity about one-third that of the Earth. The artist's depiction shows a spaceship being serviced.

This 1976 rotating space station (c) is designed to house 10,000 people. The nonrotating shell around the outside of the station shields the station from cosmic rays and solar flares. Such protection is required because this station was planned for a high orbit, at least 500 miles high, which is outside the protective blanket of the Van Allen radiation belt. The colonists here would live in houses on the inner surface of the large central sphere, which is 1 mile in circumference. The sphere rotates to produce gravity comparable to that on Earth.

The spaceship drawings are by artist William A. Kocher. They are taken from the book *Stations in Space* by Donald Cox (New York: Holt, Rinehart and Winston, 1960).



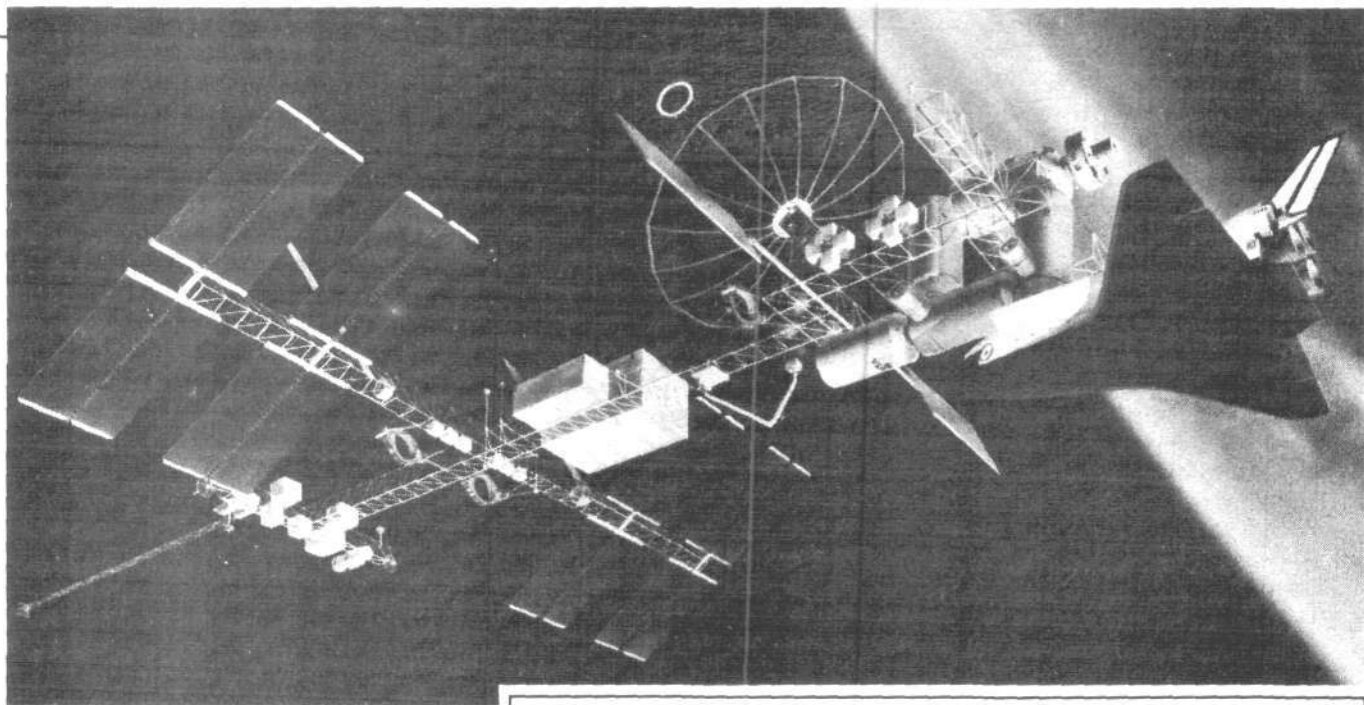

NASA

In addition to these modules, there will be machines to transport to space that will automate the erection of space structures. Grumman Aerospace Company, for example, is developing an automated beam builder. This machine takes rolled sheet metal, forms it into tubes, and welds the tubes together. These pieces become structural building parts for large structures like solar arrays and huge communications antennas.

The space station will provide a place for people to live and work. Scientists will have laboratories with equipment that allows them to do ground-breaking studies about life in space, manufacturing without gravity, and astronomical studies of the Sun, the stars, and other galaxies.

Workers living in orbit will repair satellites in space, fuel spaceships going to other planets or the Moon, and build other large structures that will be attached to the station or will orbit near it.

Scientists and engineers and others have been dreaming about building space stations for many years. In the last century, Edward Everett Hale, a New England clergyman, suggested that a space satellite (what he called an artificial moon) could be built like an Earth house—out of bricks!

**Figure 2**  
**THE 'POWER TOWER'**

*The power tower concept shown here now seems to be the most likely space station design for NASA to develop. The structure is strong, with a stable spine truss in the center, about 400 feet long.*

*The five modules for living quarters and laboratories are attached to the base, where the Shuttle is docking, and there is easy accessibility to other parts of the station. These modules can be "Earth-fixed," pointing toward Earth for work such as Earth remote sensing (detailed photography of the Earth's surface and subsurface). At the same time, the solar panels at the other end can be rotated separately so that they are always pointing toward and tracking the Sun. These panels provide about 75 kilowatts of electric power from the Sun's rays.*

*The central truss could be built in space by a beam builder; the modules would be constructed on Earth, brought up by the Shuttle, and attached to the truss. The central spine structure would also anchor the instruments for astronomical viewing.*

*This design is very flexible and could be easily enlarged by adding modules at the bottom.*

Many of the space station designs during the first half of this century assumed that the station would be rotating to create an artificial gravity (Figure 1a). These included designs by space scientists Wernher von Braun and Krafft A. Ehricke (Figure 1b).

People inside a rotating space station would be pulled toward the outer rim by centrifugal force, similar to the way gravity holds your feet on the ground as you walk on the surface of the Earth.

In more recent designs, engineers have decided that it would be easier

to work outside of the station in space if it were not spinning around. Besides, many of the things we will want to do in space, such as making perfect crystals, will need to take advantage of an absence of gravity.

#### **What Do Space Stations Look Like?**

Eventually, different kinds of space stations will be built to serve different purposes and perhaps to be in different Earth orbits.

If you have a station where scientists want to do studies of the Earth, for example, you will want the instruments on board pointed toward our planet. But other stations might

specialize in astronomy, where the scientific instruments would be pointed out toward the heavens. Astronomical observatories and industrial plants to manufacture new metal alloys, medicines, crystals, and other products would be disturbed by the movement of people around the space station. These facilities could be placed on unmanned platforms that could be serviced by space station crews.

NASA has been looking at many kinds of space station designs. Engineers have decided that the station will not be spinning. They are favoring what is called a "power tower" design, which will have the living and working quarters at one end and the solar cell arrays to power the station at the other (Figure 2).

The modules at the bottom of the power tower could be pointed toward Earth, while the module at the

top could house the telescopes and other instruments for away-from-Earth viewing.

#### An International Project

Over the next year, countries in Europe, as well as Japan and Canada will decide on how they will work with NASA to build this manned space station. Hopefully, they will decide to contribute to the space station by building modules, such as scientific laboratories like the existing Spacelab. The crews that work and live in the space station will probably come from many different nations of the world.

The space station will be the first step toward moving part of human civilization off planet Earth and into space, our next frontier. From the space station, it will be easy to return to the Moon, and then go on to Mars.

Will your address in the year 2000 be 200 miles up above the Earth?

## Viewpoint

*Continued from page 3*

research by the U.S. Army and the Department of Energy that we today can see food irradiation as a safe substitute to pesticides, a tool for export expansion, and a partial answer to world hunger. This experience proves that federal R&D pays.

#### Infrastructure Required

In order to gain widespread commercial application, a food irradiation technical infrastructure needs to be built. More field testing of the technology is required. Different types of radiation sources need to be thoroughly studied including nuclear by-products like cobalt-60 and cesium-137, X-rays, and machine-generated sources of radiation such as electron beams. Various food commodities need to be studied to see how food irradiation could be used effectively and in a cost-competitive way. Different doses under special conditions also need to be researched to determine the most desirable combination of circumstances and appropriate economies of scale.

Since cobalt-60 is in short supply, cesium should be developed as an alternative source. To help facilitate the use of cesium, my legislation establishes guidelines for leasing cesium and other nuclear by-products to the private sector, with the government retaining title as a profit-making venture to save tax dollars.

Twenty-eight foreign countries are now using gamma irradiation for food protection; and various international organizations have fully endorsed irradiation up to 1 megarad, which is 10 times higher than the 100 kilorads proposed by the FDA, as wholesome and safe. In short, the time is now to get this technology moving here in the United States.

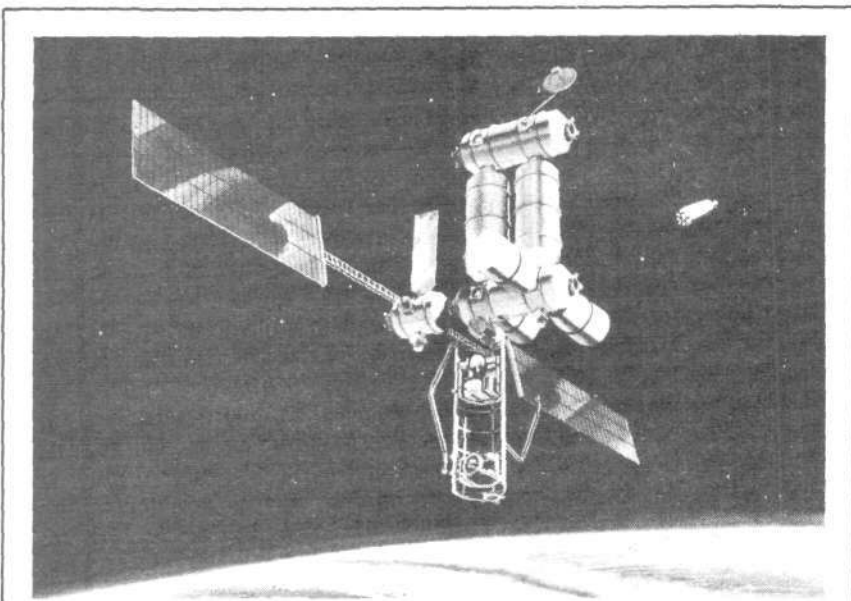

**Figure 3**

#### MORE RECENT SPACE STATION DESIGNS

*This 1982 space station design by Rockwell International shows several modules for living quarters, command and control of the station, experiments, payload storage racks, and solar panels for electrical energy.*

*Nearby (at right) is a small Orbital Transfer Vehicle that can be used to go from the station to other places in space. The vehicle can be manned or unmanned and can go to high-Earth orbit to fix communications and other satellites.*

*This space station design would be stable in its operation (not rotating). Its various units are clumped together, however, and it does not provide for unmanned platforms to house instruments and experiments away from the movement of the astronauts.*

*Contributions to the FEF  
are tax deductible!*



## Beams . . . But Not X-Rays

**Beam Weapons: The Next Arms Race**  
by Jeff Hecht  
New York: Plenum Press, 1984, \$17.95

*Beam Weapons: The Next Arms Race*, by Jeff Hecht, is one of many books and studies that have appeared in the past year on the feasibility of directed-energy defense against nuclear-armed missiles. Most of these studies, such as that of Kosta Tsipis at the Massachusetts Institute of Technology, Ashton Carter's report for the Congressional Office of Technology Assessment, and the Brookings Institution's *Ballistic Missile Defense*, are "riddled with technical errors," as a recent national laboratory review put it. Even Hecht notes of these studies: "Their analyses are so determinedly pessimistic that they can become unrealistic. . . . They have stacked the deck to come out with the answers they want to hear."

In contrast, Hecht is billed as an expert communicator for the layman on the complex technologies involved in laser and particle beam weapons. He has written scores of articles on laser technology and related subjects for *Laser Focus*, *High Technology*, *New Scientist*, and *Omni* magazines and takes what might be called a mildly pro-beam-defense view in his book.

In particular, the book is supposed to reveal the true story behind the X-ray laser: "For the first time, super-secret efforts to build X-ray lasers energized by nuclear bombs are analyzed in depth," the blurb on the cover says.

It is precisely in the area of X-ray lasers, however, that Hecht's book is itself "riddled with technical errors." Although he does not repeat the more blatant errors of the other studies concerning the X-ray laser, his analysis contains many critical flaws. Hecht tries to demonstrate, for example, that the problems of targeting, pointing, and tracking are far more difficult for the nuclear-bomb-pumped X-ray laser than for other types of more conventional beam weapons. His own data, how-

ever, demonstrate the opposite to be the case: The problems of pointing and tracking for X-ray lasers actually are orders of magnitude less than for other beam weapons.

Specifically, X-ray laser pulses destroy missiles within a *billionth* of a second, while more conventionally powered systems such as chemical lasers take from a fraction of a second to seconds. In the first case, the missile will have moved only a few inches while being lased, whereas in the second it will have moved miles. Therefore, tracking difficulties are billions of times less difficult for X-ray laser missile kills.

A second example is Hecht's implication that the X-ray laser beam would be much narrower and therefore require much greater accuracy in pointing: "The more strongly emitted X rays will be concentrated into a tight beam. . . . The narrower the beam, the more likely it is to miss its target," he writes. In fact, however, the X-ray laser pulse is projected as having much greater energy and power than conventional beam weapons and will therefore be able to destroy missiles with much more diffuse beams. Again, the facts demonstrate that pointing X-ray lasers will be orders of magnitude less difficult.

Third, Hecht implies that it would be necessary to abrogate several treaties, such as the one banning space-based testing of nuclear weapons, in order to perfect the bomb-powered X-ray laser. Actually, because of the extremely high lethality of the X-ray laser and its significantly reduced problems of targeting and tracking, nuclear-bomb-energized lasers tested in "legal" underground explosions will be more than sufficient for determining the X-ray laser beam parameters.

Once you know how the beam propagates over 100 yards, you know how it will propagate over thousands of miles. Nonnuclear components, such as targeting, pointing, and tracking, can be tested "legally" in space today. And since the whole idea of the "pop-up" X-ray laser is to deploy them

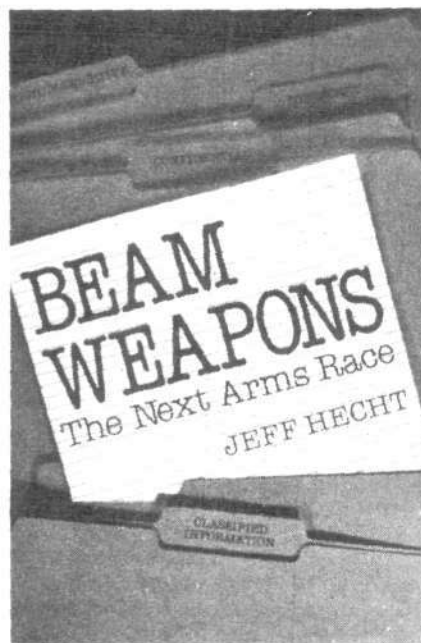

after a nuclear missile first strike has been detected, in actual use they would be no more in violation of arms control treaties than the offensive nuclear warheads being hurtled through space by Soviet ICBMs.

### 'Teller's Toy'?

Permeating Hecht's flawed technical analysis of the X-ray laser are two underlying premises:

(1) The near-term prospects for the X-ray laser are just a joke, and the whole idea is actually the product of a mad scientist—"Teller's Toy" and "first strikers" within the Pentagon" are the words he uses in the book.

(2) "If someone does find a way around the formidable technical difficulties, a pop-up X-ray laser weapon system could be the realization of the nightmares of the harshest critics of beam weapons. . . . You don't have to be a radical critic of the beam-weapon program to conclude that the most credible role for a pop-up X-ray laser system is as part of a first-strike system," he writes.

The truth is actually the opposite: Pop-up X-ray lasers uniquely demonstrate the potential capabilities for making massive, sneak first strikes militarily unthinkable and unworkable. As inadvertently detailed by the calcula-

*Continued on page 64*

# Cancer and the Big Lie

## The Apocalypitics

by Edith Efron

New York: Simon and Schuster, 1984,  
589 pages, \$19.95

The subtitle of this remarkable book, "Cancer and the Big Lie," sets out its major theme. Recounting the false allegations that synthetic chemicals produced by American industry were dooming hundreds of thousands of us to death by cancers that would not otherwise occur, the author attempts to explain how and why this happened.

In 1962, Rachel Carson warned that technology could wipe out the entire human race by the 1980s. Eight years later, a small group at the Massachusetts Institute of Technology published similar opinions in "Man's Impact on the Global Environment," a report that went directly to the United Nations as authoritative, without any peer review or analysis by competent scientists. In 1972, a computer study by this same group, commissioned by the Malthusian Club of Rome, was published under the title *Limits to Growth*. Although widely criticized as "unscientific nonsense," statements from both MIT studies have been banded about the Earth as gospel truth by those who relish predictions of global disaster.

### 'Apocalyptic Chic'

After the popular "radical chic" in this country, says the author, we have been confronted by an "apocalyptic chic." Many persons who were formerly saturated with Marxian eschatology now "harbor expectations of—or yearnings for—a cataclysmic collapse of American capitalism."

A likely explanation for the blind acceptance of apocalyptic chic, Efron believes, is that most "humanists" are untrained in science. They readily accept that the biosphere is in great peril, even though no data exist to substantiate such a claim. "Few of them noticed the voids, the logical fallacies, and the actual rejection of science that lay beneath the apocalyptic rhetoric," she says.

Space limited coverage of all facets of apocalyptic chic in this book, so Efron concentrated on the topic that elicits the greatest public anxiety,

namely, cancer. Many controversial questions are considered here:

Should *all* chemicals be considered guilty until proven innocent? What proportion of human cancers are caused by man-made synthetic chemicals? How carcinogenic are *natural* chemicals? Is it possible to prove that any synthetic or natural substances are *not* carcinogenic?

Is there a "threshold" level below which exposure to a carcinogen will *not* result in cancer development? Is a single molecule of a carcinogen sufficient to trigger cancer, as some apocalypitics theorized? How reliable is the Ames test in assessing the potential carcinogenicity of either synthetic or natural chemicals? How reliable are extrapolations from megadosed experimental rodents to humans exposed to doses thousands of times lower?

How appropriate is the Delaney Clause as a guide for regulatory agencies considering whether to ban or restrict chemicals? Should the thousands of naturally occurring carcinogens in our environment also be regulated by the Delaney Clause?

### Capricious Regulatory Agencies

Questions such as these are discussed in detail, incriminating regulatory agencies as biased and capricious, with greater interest in politics and propaganda than in seeking the truth about chemicals.

OSHA has repeatedly testified that only a very small number of chemicals are carcinogenic (belittling scientists' claims that a great many are capable of causing cancer in rodents). Refuting their own testimony, however, OSHA's 1980 policy statement specified that, "It is important to emphasize that 'negative' results in carcinogenicity bioassays simply define a limit beyond which carcinogenic activity *would have been detected*" if higher doses had been applied (emphasis added).

OSHA also said that an assay that "is not positive for carcinogenicity is the same as if the chemical has never been tested for carcinogenicity." They can thus condemn as a threat *any* chemical they wish to attack.

### 'Natural' Carcinogens

In a 1983 *Science* magazine article, Bruce Ames (who developed the Ames

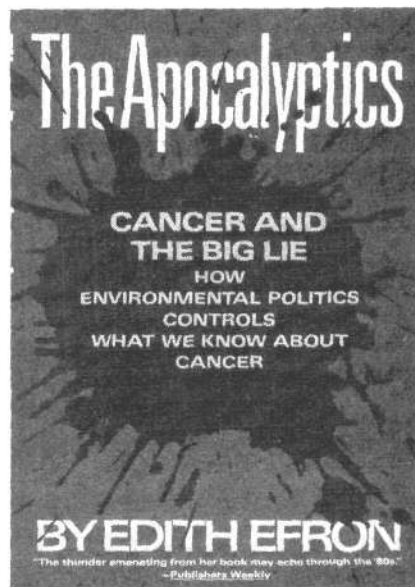

test, which screens substances for mutagenicity on microorganisms, a possible marker for carcinogenicity in higher organisms) pointed out that many natural substances are much more carcinogenic than man-made chemicals. If the naturally occurring carcinogens were viewed by regulatory agencies with the same degree of concern as synthetic substances, the public would have to be warned that very little we breathe, eat, drink, wear, use, or contain can be proven to be noncarcinogenic.

Apocalypitics could ban all man-made products, close all factories, and regulate all industrial and technological activities, says Efron, but the *natural* carcinogens would still be everywhere and could not be avoided or turned off. Obviously the no-threshold, single-molecule theory would never have been proposed if the natural carcinogens had been properly acknowledged before the apocalyptic propaganda concerning man-made substances was exploited!

Unfortunately, the author's reliance on many scientists who requested anonymity may diminish the acceptance of her book. Such anonymous sources were not needed, since many outstanding scientists already had been publicly proclaiming those same facts for decades and were readily quotable sources. Efron failed to give credit to those authorities, such as George Claus, Thomas Jukes, Edward Laws, Robert White-Stevens, and many others who were leaders in the long fight against apocalyptic propaganda.

A great many other scientists were,



however, given good treatment in the book and contributed to the overall credibility of Efron's allegations.

#### Scientific Truth versus Delusion

If this dramatic book receives the media attention that it deserves, it may help rejuvenate the ancient objective of "truth in science." Also, reporters (and politicians) could not so easily misinform readers, viewers, and listeners with myths about "cancer epidemics" in the United States.

The public has been brainwashed

into believing that "chemicals" are evil, while "nature" is benign. Efron thinks most people are now wise enough to realize that those who frightened us concerning man-made carcinogens, while avoiding all mention of natural carcinogens (even though they were well aware of them), were either seeking to generate more antitechnology funding for themselves or were simply hoping to pit us against our own industrial and economic system.

As Efron says, "When the public un-

derstands the magnitude of the ideological delusion in which the entire country was enmeshed, a few more sophisticated questions will be asked, for example: While the Biologist State was concocting a pseudo-science and regulating industry on the basis of a fairy tale . . . while it was suffocating human minds with myth . . . where were the critical scientists who knew that this was happening . . . and where was the watchdog press?"

—Dr. J. Gordon Edwards

## A Solid Program for Space Exploration

### Bound for the Stars

by Saul J. Adelman and Benjamin Adelman  
Greenwood Cliffs, N.J.: Prentice-Hall, 1981

Steering clear of the twin perils of science fiction and mundane reporting of present plans and past accomplishments, *Bound for the Stars* lays out a clear, scientifically competent, and yet imaginative program for man's future exploration and conquest of space.

Written by a father-and-son team of science writer and astrophysicist, the book is almost unique in its strong pronuclear bias and its location of the development of technologies necessary for the conquest of space in the context of simultaneously developing those high-energy technologies necessary for the industrial development of the Earth. In accordance with this outlook, the book contains an excellent refutation of the "L-5" fantasy of moving select portions of mankind into solar-powered Hiltons in space, an antisocial vision that is largely hegemonic among much of the popular space literature.

The book's greatest strength lies in its correct emphasis on the importance of propulsion technology, and nuclear propulsion in particular, to the future of space exploration. The authors explain the importance of going beyond our present chemical rockets, which can gain a maximum specific impulse of 450 seconds of thrust per pound of fuel, to solid-core nuclear rockets like the Nerva, which could attain 900 seconds; gas-core fission rockets, which might attain from 2,500 to 5,000 seconds; and fusion rockets,

whose specific impulses can reach up to a theoretical limit of 1 million seconds.

They then narrate the suppressed story of the history of successful development of nuclear rockets in the United States, and the wrecking of the program through budget cuts. "This is not a scientific failure or an engineering failure," they accurately conclude. "It is a political failure of the first magnitude." Before these cuts, NASA had planned a manned mission to Mars by 1981. Now the Soviets are announcing that they will accomplish this first for mankind.

#### Fusion in Space

The authors go on to an inspiring discussion of how the same fusion-based technologies that will make quick interplanetary travel cheap and routine will also ultimately make possible the settlement of solar systems throughout the galaxy. They show how a straightforward fusion rocket, such as that outlined in the British Interplanetary Society's Project Daedalus, which might attain a maximum velocity of 12 percent of the speed of light, is marginally applicable for such a task.

R.W. Bussard's interstellar ramjet, however, which gathers its fusion fuel from interstellar hydrogen using large magnetic fields and thus can attain velocities close to that of light, may someday give man a practical solution for interstellar flight in reasonable time scales. The Adelmans also discuss a number of ideas, such as the proposal by Daniel Whitmire to use either the neon-sodium or the carbon-nitrogen-oxygen cycle to catalyze the hydrogen fusion reactions in the ramjet, that

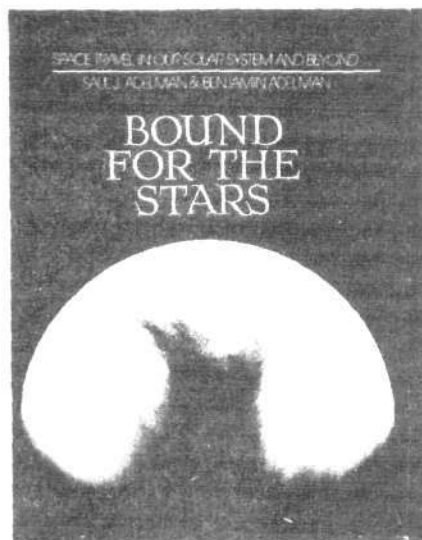

represent significant steps toward solution of the many technological problems that will have to be solved before the Bussard ramjet can be realized.

The book also contains an excellent chapter on possible astronomical techniques that could be used in the near future to detect other solar systems, and a fair chapter (although of somewhat inadequate detail) about possible techniques that might be used to transform other planets within our solar system, especially Mars, into habitable planets.

The writing in *Bound for the Stars* is clear enough to be understandable by a bright high school student, while the information is detailed enough to make the book valuable and interesting to those with extensive scientific education. Serious researchers will find especially valuable the extensive list of sources and technical paper references that follows each chapter.

—Robert Zubrin

# Books for Young Scientists

**On the Path of Venus: Discovering the Structure of Our Solar System** by Lloyd Motz, and **Experiments in Space Science** by Peter Greenleaf are both recommended for inquiring minds at the seventh through tenth grade level. Others, including especially science teachers, can learn something of pedagogy from these books.

*On the Path of Venus* (New York: Pantheon, 1977, \$7.95 hardcover) traces the process of discovery of the solar system's order, from Aristarchus to Newton. How did Aristarchus figure out that the Earth orbits the Sun? Motz demonstrates in detail what observations lead to this result and tells how this great achievement was "forgotten" until Copernicus.

Motz's assertion that Newton and Einstein are the two greatest scientists in history is far from the truth; yet his book discloses the dialogue a great mind has to carry on with its predecessors, and with the evidence, to reach a great advance.

*Experiments in Space Science* (New York: Arco Publishing, 1984, \$4.95 paperback) is not a beautiful book to look at, but its contents are outstanding. Since astronomy is the foundation of space science, it is appropriate that this book is chiefly astronomy. How to build a transit to find your latitude; make a sky clock to tell time from the stars; locate and trace the ecliptic in spring and winter; find the perigee and apogee distances of the Moon from the Earth; plot the orbits of the planets; distinguish sidereal from solar time; gather and separate cosmic dust from Earth dust; make a spectroscope; make a reflecting telescope—this is a sample of the contents.

**Wonders of the Sky—Observing Rainbows, Comets, Eclipses, the Stars, and Other Phenomena** by Fred Schaaf (New York: Dover Publications, 1983, \$6.95 paperback), although not billed as a book for young people, is so written that a serious ninth grader could read it. The book is devoted to naked-eye astronomy, and its distinctive feature is poetic thinking, which is the proper point of departure in science.

In his preface Schaaf observes: "What children at first have, and adults

largely lose, is the sense of wonder. But is it inevitable that gaining more experience of the world should result in loss of wonder? Not always. If a person resists the tyranny of thinking that all his factual knowledge and classifications are justifiably fixed and final, . . . he can retain some of that native wonder and bring it to his experience of a world far more complex and rich than that of any child."

*Wonders of the Sky* is an observer's

## Beams ... But Not X-Rays

*Continued from page 61*

tions of Ashton Carter in his report for the Office of Technology Assessment, just one submarine with 10 or more X-ray lasers to pop up could negate a full simultaneous Soviet launch of 1,000 missiles. And as the recent government revelations made in countering the Office of Technology Assessment report by Ashton Carter emphasize, the bomb-pumped X-ray laser has a tremendous potential for making missile defense workable, boost-phase intercept in particular.

It is important to note in this context that it is not necessary to be capable of killing all Soviet missiles launched in a sneak first-strike salvo. Even a 60 percent kill capability, accomplished at a small cost, would be more than sufficient to militarily deter any such attack. Sneak first strikes, therefore, would no longer be a rational option for Soviet military planners.

Hecht, however, then takes these objections further: He suggests that the X-ray laser never be developed by the United States. . . . I cannot see adequate reasons for a crash-priority, multibillion dollar program," he says. Hecht also downplays "reports" that the Soviet Union has a far larger and more advanced beam-weapon defense program underway:

"The Soviet Union historically tends toward making risky demonstrations early in a development program. . . . The Soviet Union managed a first few spectacular shots, most notably Sputnik, but was eventually overtaken by

guide that will teach the beginner a great deal.

**Astronomy Handbook** by James Muir- den (New York: Arco Publishing, 1982, \$8.95, hardcover) is suitable for an eighth grader on up. The book's brilliant and well-captioned color photos and diagrams literally create in the viewer an urge to read the book. The young person who wants to learn about astronomy could work his or her way through this book quickly—and be well prepared for more challenging materials.

—David Cherry

the United States. In keeping with this pattern, the Soviet Union might be the first to demonstrate (or try to demonstrate) a laser weapon, but that demonstration might not indicate a commanding lead," he writes.

### Who Is Jeff Hecht?

Once you realize that the technical cover for these observations about the X-ray laser is riddled with errors, it then becomes obvious that Hecht must have some other motivation for his views. Clearly, his purpose is not to support real beam-weapon missile defenses or give people an accurate assessment of the potential of the X-ray laser.

Perhaps some light may be shed on Hecht's selective reporting if we look at one of the more revealing examples of Soviet espionage that he briefly discusses:

"High-energy laser mirrors are high on the Pentagon's list of strategically important technologies. Thus, government officials became very upset when a metal mirror able to withstand high laser powers found its way from Spawr Optical Research Inc., a small company in Corona, California, to the Soviet Union, through the company's West German sales representative. . . . Both Spawr personally and the company were convicted of violating export regulations."

A most interesting case history—but the author neglects to point out that Spawr at the time was publisher of *Laser Focus* magazine while Hecht was the managing editor.

—Charles B. Stevens

# The world will have widespread fusion power by the year 2000.

The only question is whether it will be delivered by an ICBM or a tokamak.

It's up to you!

With your help, the Fusion Energy Foundation can

- put *Fusion* magazine into the hands of 200,000 progrowth Americans
- educate America on the benefits—economic, military, and scientific—of developing directed energy beam technologies
- send speakers nationwide to debate nuclear freeze advocates on campuses and at community meetings
- promote science and technology—specifically the development of nuclear fusion and fission and space exploration—as the most important tools for continuing human progress.

Join the Fusion Energy Foundation and give gift subscriptions to *Fusion* magazine.

**Yes** I want to support the Fusion Energy Foundation.

Enclosed is:

Sustaining membership \$250

Individual membership \$75

Corporate membership \$1,000

(All memberships include 6 issues of *Fusion*)

1-year subscription to *Fusion* \$20 (6 issues)

2-year subscription to *Fusion* \$38 (12 issues)

Make checks payable to Fusion Energy Foundation, Box 1438, Radio City Station, New York, N.Y. 10101

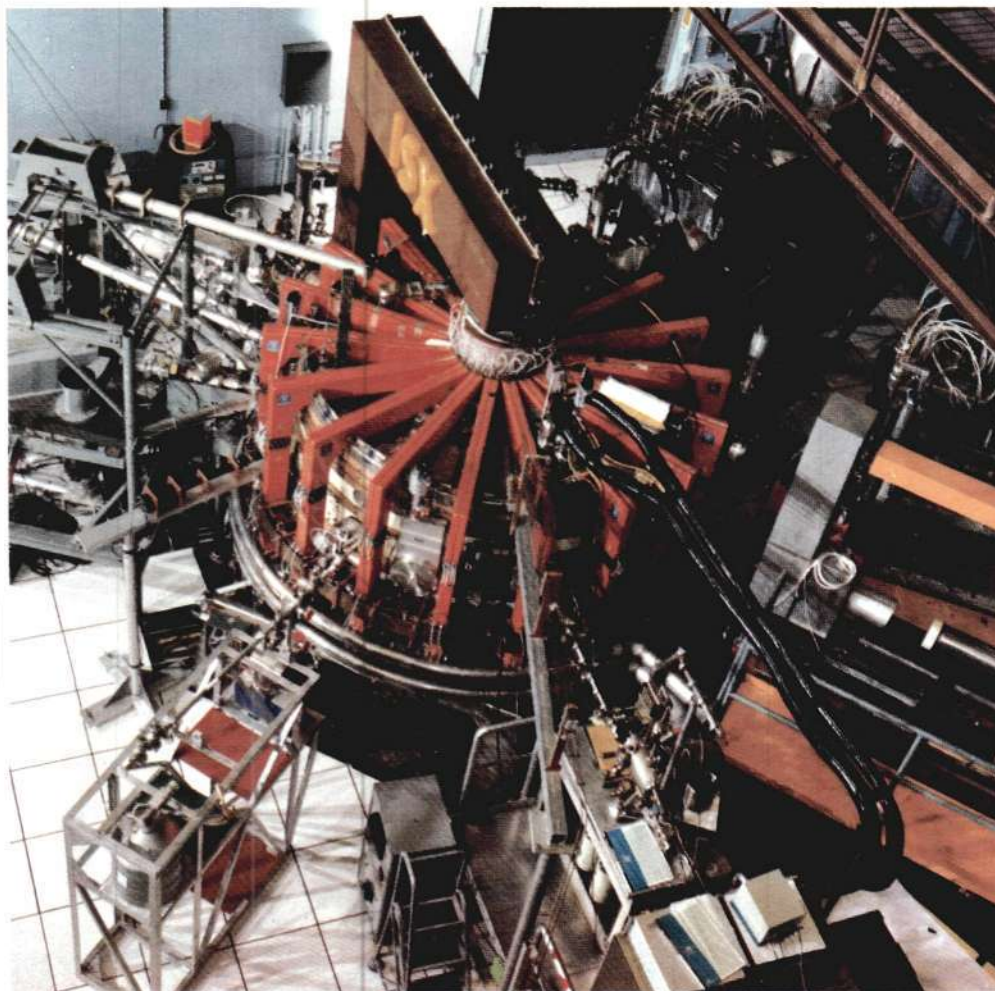

Oak Ridge National Laboratory

Name \_\_\_\_\_

Address \_\_\_\_\_

City \_\_\_\_\_ State \_\_\_\_\_ Zip \_\_\_\_\_

Credit card \_\_\_\_\_ Card number \_\_\_\_\_ Expiration Date \_\_\_\_\_

Contributions to the Fusion Energy Foundation are tax deductible. Visa, MasterCard, and Diners accepted.

## In This Issue

### ASTRONOMY: THE FOUNDATION OF SCIENTIFIC METHOD

Astrology and magic, age-old weapons in the war against science and reason, are today becoming hegemonic in the minds of much of the



Stuart K. Lewis

*Reviving astronomy: This display of how to measure the precession of the equinoxes is part of a pedagogical museum prepared for the 225th birthday celebration of the German poet Friedrich Schiller.*

population. Jonathan Tennenbaum discusses why astronomy is the foundation of scientific method and why it must be revived if we are to defeat the forces of unreason. To illustrate the basics of astronomical science, he presents the fascinating account of a 40,000-year-old astronomer and his civilization and how they determined the laws of the universe.

Bringing this process of astronomical knowledge up-to-date, Carol White discusses the current work of the Mexican astronomer Luis Carrasco. Carrasco has extended the method of Kepler to relate the mass and spin of astronomical objects over 40 orders of magnitude, thereby accounting for the formation of all observed astronomical structures in the universe.

### EVERYTHING ANYONE NEEDS TO KNOW ABOUT WHY BEAM DEFENSE WORKS

U.S. scientists in the national laboratories have recently demonstrated the near-term potential of the whole range of antiballistic missile defense capabilities—from Earth-basing or low-Earth orbit and "pop-up" deployment, to geosynchronous orbit

22,000 miles up and beyond. In short, the U.S. labs are doing what the beam defense critics say is "impossible." FEF executive director Paul Gallagher describes these advances in detail and refutes the anti-beam-defense arguments of the self-described "Shadow Cabinet" at MIT and Harvard.

### FOOD IRRADIATION TECHNOLOGY:

#### LET'S TAKE IT OFF THE SHELF

Low-dose irradiation could save the 33 million tons of grain per year that never reaches the consumer because of insect infestation and spoilage—enough to feed 230 million people for a year. Irradiation retards spoilage, prolongs shelf life, eliminates insect infestation, kills microorganisms like trichina in pork, and ensures purity.

As Marjorie Mazel Hecht documents, after 40 years of rigorous testing for safety and wholesomeness, food irradiation has come out with a clean bill of health. It's time for the United States to stop stalling and commercialize this technology. Then we can get on with the job of feeding the world efficiently.

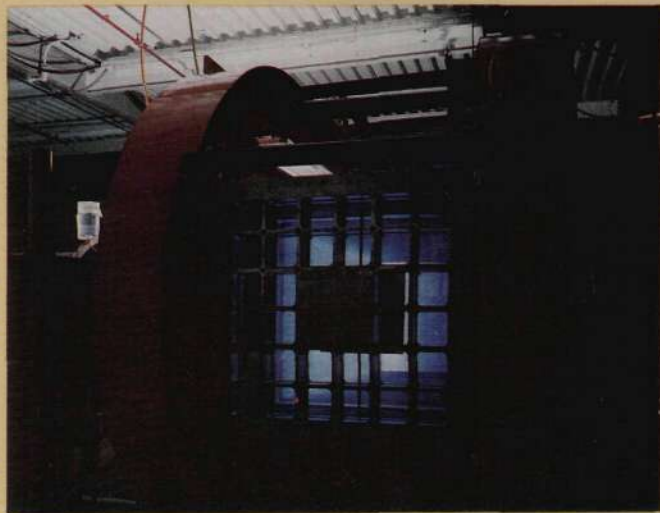

Los Alamos National Laboratory

*The krypton fluoride laser, now being developed at Los Alamos National Laboratory, has about the shortest wavelength with which optical transmission can be achieved, and it will be capable of killing missiles within the atmosphere and in their boost phase. Shown here are the red magnets that confine the electrons that energize krypton fluoride gas. The grid is a 32-piece glass mosaic through which laser light is delivered.*



Courtesy of Jacek Sivinski/CH2M Hill

*Food irradiation can save fish, a major source of protein in Asia, from spoilage. Shown here are bags of dried fish in Bangladesh. The fish irradiated with 100 kilorads (left) remains insect-free, while nonirradiated fish (center and right) has been eaten away by insects.*